

rubinetterie
MARIANI



COLLECTION
2021-22



rubinetterie
MARIANI

L'ELEGANZA NON HA TEMPO, CAMBIANO LE MODE MA UNA SCELTA DI CLASSE RIMARRA' SEMPRE UNA ICONA DI STILE.
ELEGANCE IS TIMELESS, FASHION CHANGES BUT A CHOICE OF CLASS WILL ALWAYS KEEP AN ICON OF STYLE.





rubinetterie
MARIANI

DESIGN



AVENUE
36



5TH AVENUE
52



ARMONIA
70



ULTRAMINIMAL
82



POLAR
94



NEXT
110



RIVER
128



STILNOVO
136

INOX



ULTRAMINIMAL 316
142



WELLNESS INOX
152



KITCHEN INOX
162



ACCESSORIES INOX
166

URBAN



ARTIC
172



SURF
188



SURF ECO
204



MARTE
212



HERMÈS
220



ESSENZA
230



MAXIMA
238



EPIC
242

STYLE



TRADITION
252



MEISSA
260



DOMINO
268

WELLNESS



CROMOTERAPIA
CHROMOTHERAPY

276



SOFFIONI
SHOWER HEAD

296



BOCCH
SPOUTS

318



BOX INCASSO
BUILT-IN BOX

324



INCASSI
BUILT-IN

334



TERMOSTATICI
THERMOSTATICS

338

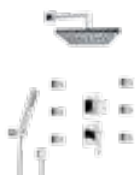

SET DOCCIA
SHOWER SET

360



PANNELLI DOCCIA
SHOWER PANEL

384



COLONNE DOCCIA
SHOWER COLUMN

390



SALISCENDI
SLIDING RAILS

402



DOCCETTE
HANDSHOWERS

408



SHUT-OFF
HYDROBRUSH

418



SET PER BORDO VASCA
DECK MOUNTED BATHTUB SET

424

KITCHEN



DESIGN

430



TOUCH ME

452



ACQUA DEPURATA
DRINKING WATER

456



BOCCA ALTA
HIGH NECK

462



BOCCA BASSA
LOW NECK

472



A PARETE
WALL MTG.

476



DOPPI COMANDI
DOUBLE HANDLE

482

HI-TECH



SENSOR

488



TEMPOR TOUCH

498



TEMPOR

502

COMPONENTS



COMPONENTI

510

La nostra storia *Our history*

La storia delle Rubinetterie Mariani ha inizio nei primi anni '60 a Milano.

I fratelli Mariani avviano l'attività produttiva nel quartiere di Gorla e pochi anni dopo la trasferiscono negli attuali stabilimenti di Zingonia in provincia di Bergamo, più adeguati per spazi e macchinari ad una realtà in forte crescita.

Già all'epoca occupa oltre 150 collaboratori organizzati in reparti specializzati e dotati di attrezzature all'avanguardia per eseguire con precisione tutte le fasi della produzione in serie della rubinetteria: stampaggio a caldo dell'ottone con l'impiego di robot, reparto macchine transfer e plurimandrino, macchine per la pulizia dei pezzi destinati alla cromatura, impianto di cromatura, reparto montaggio e collaudo, pulizia ed inscatolamento dei rubinetti, laboratorio test e controllo qualità, deposito del prodotto finito, reparto imballaggio e spedizione.

Nel 1974 l'azienda entra a far parte del gruppo americano Masco Corporation, primo gruppo mondiale nel settore della rubinetteria industriale, e con loro sviluppa un insieme di azioni sinergiche che si traducono nell'acquisizione di nuove competenze gestionali.

Dal 1° gennaio 2008 l'azienda lascia la multinazionale americana e torna ad essere completamente italiana, investendo in nuove tecnologie e nello sviluppo di nuovi design.

Oggi Rubinetterie Mariani è una realtà produttiva che, forte dell'esperienza maturata e della propria storicità, intrattiene stabili rapporti commerciali in tutta Italia e in molte nazioni nel mondo.

Il suo marchio e le sue proposte di rubinetteria continuano a rendersi portavoce di una "Qualità che dura nel tempo".

The history of Rubinetterie Mariani began in the early 1960s in Milan (Italy).

The Mariani brothers started faucets production in the Gorla district and a few years later they moved it to the present factories in Zingonia in the province of Bergamo (Italy), more suitable for spaces and machinery for a strong growth.

Already at that time, it employed over 150 employees organized in specialized departments with advanced equipment to accurately complete all the stages of serial faucet production: brass hot forging with the use of robots, department transfer machines and multi-spindle, machines for the cleaning of the pieces for chrome plating, chrome plating plant, assembly and testing department, cleaning and boxing of taps, laboratory testing and quality control, storage of the finished product, packaging and shipping.

In 1974 the company became part of the American group Masco Corporation, the first global group in the sector of industrial faucets, and with them developed a set of synergistic actions that resulted in the acquisition of new high management skills.

From 1 January 2008 the company leaves the American multinational and returns to be completely Italian, investing in new technologies and developing new designs.

Today Rubinetterie Mariani is a productive reality that, thanks to the experience gained and its historicity, maintains stable business relationships throughout Italy and in many countries around the world.

His brand and his faucet proposals continue to become the spokesman of a "Quality that lasts over time".

1960

Mariani

1974

RUBINETTERIE
Mariani

2008

rubinetterie
MARIANI



Materiali e processi produttivi

Grandi stabilimenti produttivi per lavorazioni di prodotti da barra, da stampato, da fuso, da tubo e da lastra tramite macchinari di ultima generazione ad alta automazione, asserviti e robotizzati, reparto di pulitura, reparto di cromatura, verniciatura e finiture di pregio.



Material and manufacturing process

Wide production facilities for bar, forged, molded, tube and sheet productions through last generation italian machineries at high automation, asserved and robotized, polishing department, chrome plating, vanishing and high end finishing production departments.



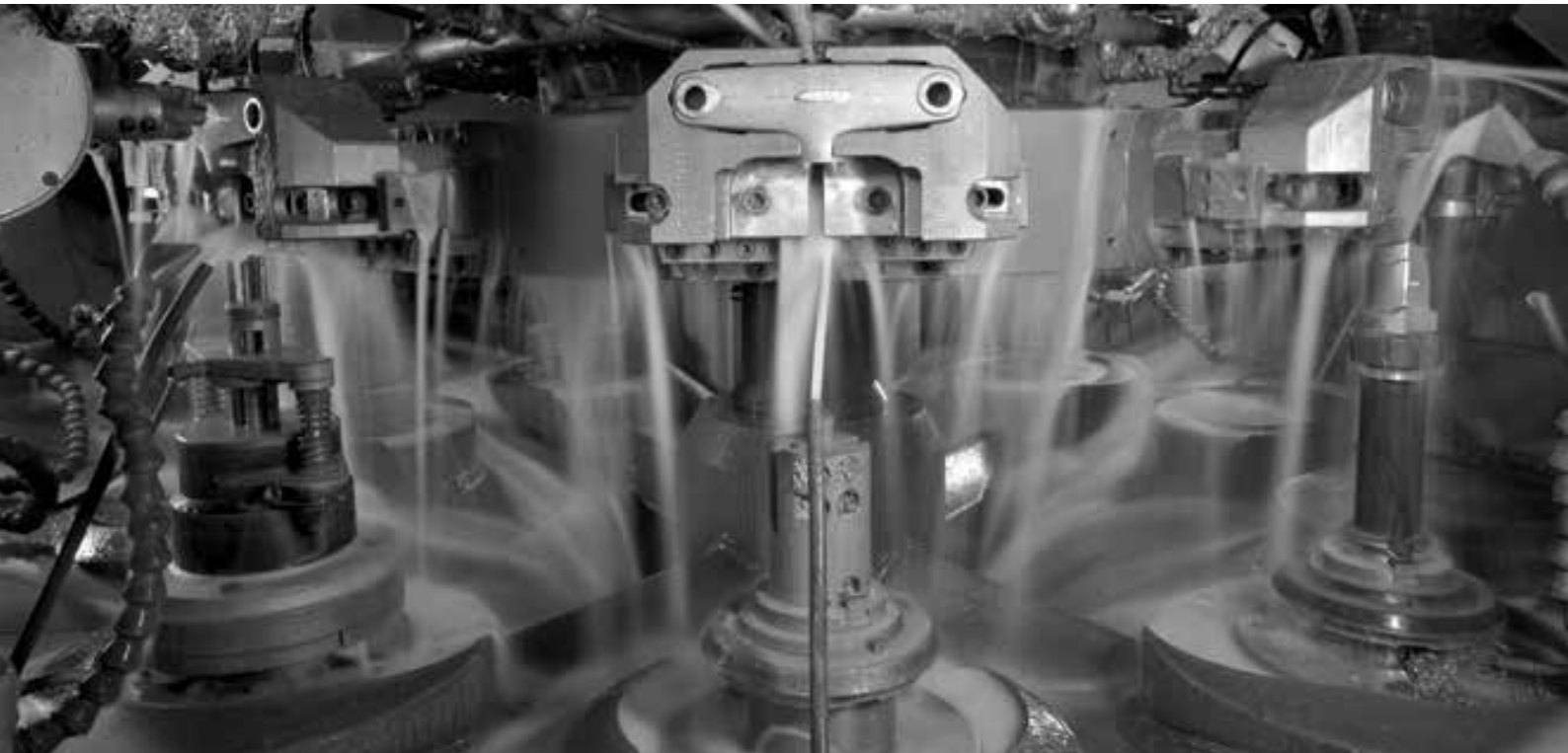

Certificazioni - *Certifications*

Rubinetterie Mariani é un'azienda certificata ISO9001, certificazione di qualità aziendale. Abbiamo inoltre importanti certificazioni anche a livello internazionale:

Rubinetterie Mariani is a company certified ISO9001, certification of quality company. We've also important International certifications:



Componenti utilizzati nei nostri miscelatori

Components used in our mixers



I miscelatori ed i prodotti a contenuto elettronico di Rubinetterie Mariani godono di una garanzia di qualità aggiuntiva: cartucce a dischi ceramici per monocomando, cartucce termostatiche, deviatori per doccia e componenti elettronici sono tutti prodotti dall'azienda italiana S.T.S.R. - Studio Tecnico Sviluppo e Ricerche con stabilimenti a Lacchiarella (Milano), Italia.

S.T.S.R. nasce nel 1985 come Studio Tecnico di Sviluppo e Ricerca dell'azienda multinazionale Masco brevettando nel corso degli anni numerose soluzioni relative sia a cartucce che a tecnologie elettroniche innovative. Macchinari all'avanguardia coprono l'intero ciclo produttivo dei componenti, dallo stampaggio delle speciali plastiche utilizzate, fino all'assemblaggio e ai test finali con macchine automatiche ad alta precisione. L'azienda è inoltre dotata di un laboratorio di analisi dedicato a test quotidiani aggiuntivi per mantenere il controllo sulle performance dei propri prodotti secondo le principali Certificazioni di settore. Tutto questo si traduce in una garanzia di alta qualità MADE IN ITALY che consolida l'affidabilità a lungo termine dell'intera offerta di Rubinetterie Mariani.

Rubinetterie Mariani faucets and electronic products have an additional quality guarantee:

ceramic disk cartridges for single-lever mixers, thermostatic cartridges, shower diverters and electronic components are all produced by the Italian company S.T.S.R. - Development and Research Technical Study with plants in Lacchiarella (Milan), Italy.

S.T.S.R. was founded in 1985 as the Technical Study of Development and Research at Masco multinational company, patenting over the years numerous solutions relating to both cartridges and innovative electronic technologies. Last generation machinery covers the entire production cycle of the components, from the molding of the special plastics, up to the assembly and to the final tests with automatic high-precision machines.

The company also has an analysis laboratory dedicated to additional daily tests to maintain control over the performance of its products according to the main sector certifications.

All this translates into a high quality MADE IN ITALY guarantee that consolidates the long-term reliability of the entire Rubinetterie Mariani offer.



Rubinetterie Mariani completa la propria offerta utilizzando esclusivamente tubi flessibili prodotti in Italia con macchinari automatizzati a garanzia di elevati standard qualitativi. Flexitaly s.r.l. è l'azienda partner che si occupa della produzione dei flessibili presso gli stabilimenti di Cassano d'Adda (Milano), Italia. Nata nel 1985, Flexitaly dispone di propri stabilimenti con impianti ad alta precisione che chiudono al loro interno l'intero processo produttivo, partendo dalla trecciatura del tubo (gomma epdm e filo secondo specifica) e giungendo al prodotto finito con l'ausilio di minuterie e raccorderie anch'esse create internamente. Ogni fase produttiva è quindi gestita con la massima attenzione sia ai processi di lavorazione che a materiali e tolleranze. Il risultato finale è un prodotto completamente MADE IN ITALY, progettato e creato per essere altamente performante, atossico ed estremamente durevole nel tempo. Un ulteriore dettaglio di qualità che correda l'intera offerta di Rubinetterie Mariani.

Rubinetterie Mariani completes its offer using exclusively flexible hoses produced in Italy with automated machinery to guarantee all the high quality standards. Flexitaly s.r.l. is the partner company that deals with the production of flexible hoses inside its factory in Cassano d'Adda (Milan), Italy. Founded in 1985, Flexitaly has its own plants with high-precision systems that enclose the entire production process, starting from the hose braiding (epdm rubber and wire according to specification) and using small parts and fittings that are also internally produced to get to the finished product. Each production phase is therefore managed with the utmost attention both to the manufacturing processes and to materials and tolerances. The end result is a completely MADE IN ITALY product, designed and created to be highly performing, non-toxic and extremely durable over time. An additional quality detail that accompanies the entire offer of Rubinetterie Mariani.

I prodotti

Il catalogo di Rubinetterie Mariani offre un'ampia scelta di stili e di soluzioni per gli ambienti di bagno e cucina, dai design più moderni alle serie tradizionali.

Le numerose collezioni della gamma spaziano tra le diverse tipologie di rubinetteria: monocomando, bicomando, termostatica, temporizzata ed elettronica oltre a proporre intere e innovative soluzioni wellness per ambienti doccia, idroterapia e cromoterapia.

L'utilizzo di avanzate tecnologie nella produzione e l'accurata scelta dei materiali garantiscono elevati standard di qualità.

Assidui controlli effettuati in ogni fase di lavorazione, fino al severo collaudo finale sanciscono la validità del prodotto nel tempo. L'alto livello qualitativo trova poi la sua espressione visibile nell'eleganza e nella purezza delle linee.

L'armonia dei progetti e la raffinatezza delle finiture connotano un design tipicamente italiano, in grado di emozionare anche il Cliente più esigente.



The products

Rubinetterie Mariani Catalogue offers a wide choice of styles and solutions for bathrooms and kitchens, from modern designs to traditional series.

The wide collections ranging between different types of faucet: single-lever, 2 handles, thermostatic, temporized and electronic as well as offering entire and innovative wellness solutions for shower rooms, hydrotherapy and chromotherapy.

The use of advanced technologies in the production and accurate choice of the most reliable materials guarantee high standard quality.

Regular inspections at every stage of processing, up to severe final testing confirm the validity of the product in the time.

The high quality level find his visible expression in elegance and purity of the lines.

The harmony of the projects and the refined finishes are typical Italian design, able to excite even the most demanding Customer.







rubinetterie
MARIANI

Finiture

Per favorire la personalizzazione e l'originalità dei vostri progetti d'arredo, è possibile scegliere tra 4 diverse opzioni di finitura aggiuntive. Verifica all'interno di questo catalogo quali colori sono stati selezionati per ogni collezione e quali articoli sono realizzabili in finitura.

14 NERO OPACO
MATT BLACK



37 BIANCO OPACO
MATT WHITE



Finishings

To facilitate the customization and originality of your interior projects, you can choose from 4 different additional finishing options. Check within this catalog which colors have been selected for each collection and which items can be made with a finish.



08 NICHEL SPAZZOLATO
BRUSHED NICKEL

Comfort totale

TOTAL-COMFORT è l'impegno di Rubinerterie Mariani nell'offrire delle soluzioni di rubinetteria a misura delle diverse esigenze della Clientela. La varietà di gamma all'interno del catalogo rende disponibili i prodotti Mariani in molteplici varianti di forma, altezza, dimensione o inclinazione per permettervi di scegliere la soluzione più adatta alle vostre esigenze.

Ne sono d'esempio i miscelatori per lavabo che grazie alle tante altezze e alle diverse profondità permettono di completare anche gli arredi più originali, le soluzioni a incasso per il wellness totalmente componibili e i modelli di soffioni adatti a spazi doccia di ogni dimensione. Anche la sezione cucina è sviluppata in un'ottica di TOTAL-COMFORT: in base alle vostre preferenze e allo spazio disponibile potrete infatti selezionare il modello di miscelatore con la tipologia di bocca più pratica per altezza, inclinazione e prestazioni.



BASSO
LOW

MEDIO
MEDIUM

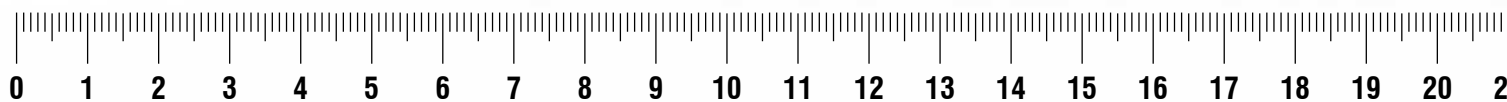

Total comfort

TOTAL-COMFORT is the commitment of Rubinetterie Mariani in offering tailored made solutions for its Customers. The variety of ranges and proposals in our Catalogue includes multiple variations of shape, height, size or inclination to allow you to choose the solution that best suits your needs.

Examples of this are the basin mixers which, thanks to the many heights and depths, make it possible to complete even the most original furnishings, the fully modular built-in wellness solutions and the models of shower heads suitable for shower spaces of any size. Also the kitchen section is developed in a TOTAL-COMFORT perspective: depending on your preferences and the available space, you can in fact select the mixer model with the most practical type of spout for height, inclination and performance.



COMFORT TOTALE *TOTAL COMFORT*

pannelli doccia - shower panels

soffioni - shower heads

set vasca da pavimento

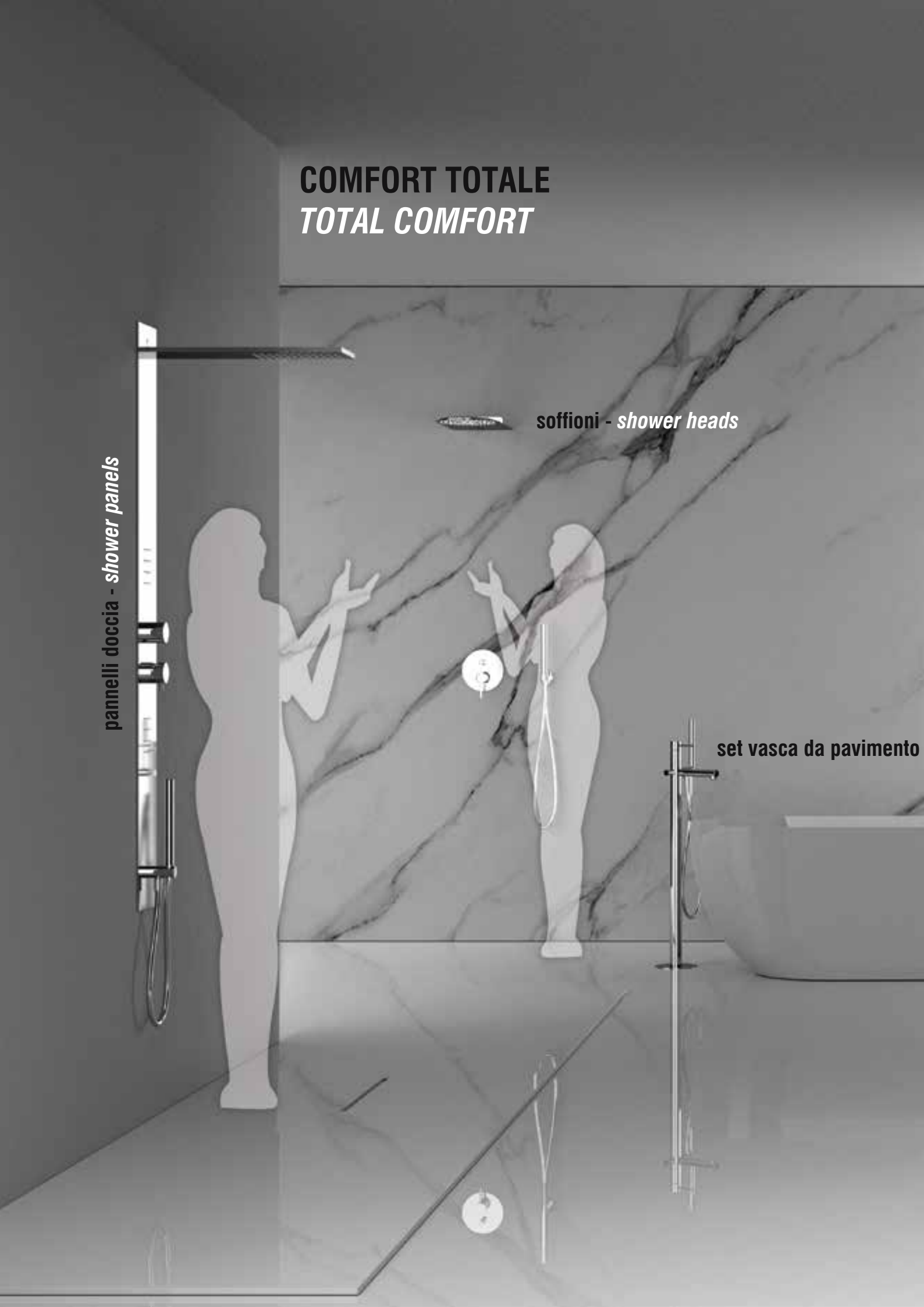

- floor mounting bath set

bocca da soffitto - ceiling spout

lavabo da terra - floor mounting basin

rubinetterie
MARIANI

Benessere

Un'importante sezione della produzione di Rubinetterie Mariani è dedicata al Wellness. Soluzioni per vasca e ambienti doccia di grande stile capaci di portare tutti i benefici di un centro benessere a disposizione di un utilizzo quotidiano: getti ad incasso orientabili, soffioni a pioggia e a cascata, nebulizzazione e idroterapia.

Sappiamo che il potere rilassante dell'acqua può inoltre essere amplificato dall'irradiazione di piacevoli successioni cromatiche. Per questo motivo diverse proposte di Rubinetterie Mariani integrano soluzioni per la doccia ad alto contenuto tecnologico con l'effetto naturale e distensivo della cromoterapia.



Wellness

An important section of the production of Rubinetterie Mariani it is dedicated to Wellness. Stylish solutions for bathtub and shower settings bring all the benefits of a SPA available for daily use: adjustable concealed jets, rain and waterfall shower heads, nebulization and hydrotherapy. We know that the relaxing power of water can also be amplified by irradiation of pleasant successions of colors. For this reason, various proposals of Rubinetterie Mariani integrate high-tech shower solutions with the natural and relaxing effect of the color therapy.



TECNOLOGIA PER ARREDARE TECHNOLOGY TO FURNISHING

Color Led Fountain

La rubinetteria con cartuccia COLOR LED FOUNTAIN integrata permette di aggiungere un tocco di stile ed originalità agli ambienti di bagno e cucina. Sfruttando il solo passaggio dell'acqua, la cartuccia genera una luce led colorata che accompagna il flusso dell'acqua e illumina delicatamente lo spazio circostante.

Questa tecnologia è integrata di serie in bocche e miscelatori a soffitto della collezione STILNOVO LIGHT ed è disponibile in due versioni: una termosensibile che cambia colore seguendo la temperatura dell'acqua (A) e una "arcobaleno" che produce una rilassante rotazione cromatica indipendente dalla temperatura (D).

Vedi collezione STILNOVO LIGHT a pagina 142

NOTE:

La tecnologia COLOR LED FOUNTAIN non necessita di alimentazione elettrica e si aziona a 2.5 litri/minuto.

La cartuccia è dotata di filtro in entrata che permette alla turbina di lavorare isolata dalle impurità presenti nell'acqua.

Questa tecnologia è disponibile in due varianti denominate A e D, di seguito dettagliate.

Per evidenziare la Vostra scelta, specificare la lettera della variante all'interno del codice prodotto al momento dell'ordine.

Faucets with integrated COLOR LED FOUNTAIN cartridge allow you to add a touch of style and extravagance to bathrooms and kitchens.

Powered only by the water transit, this cartridge generates a colored led light that accompanies the water flow and that reflects a magical atmosphere in the sink.

This technology is integrated as standard in the ceiling spouts and mixers of the STILNOVO LIGHT collection and is available in two versions: a temperature sensitive cartridge that changes color according to the water temperature (A) and a "rainbow" version to create an independent relaxing color rotation (D).

See STILNOVO LIGHT collection on page 142

NOTE:

COLOR LED FOUNTAIN technology does not require an electrical power supply and operates at 2.5 liters/minute.

The cartridge is equipped with an inlet filter that allows the turbine to work isolated from the water impurities.

This technology is available in three variants named A and D, detailed here below.

To highlight your preference, please specify the letter into the product code when ordering.

91ASNR



La luce emanata cambia colore al variare della temperatura

The light emitted changes color with temperature

A

Blu : fino a 28°
Verde : da 28° a 38°
Giallo : da 38° a 44°
Rosso : da 44°

Blue : up to 28°
Green : from 28° to 38°
Yellow : from 38° to 44°
Red : from 44°

91DSNR



Un arcobaleno di colori e sfumature si alternano creando un continuo gioco emozionale

A rainbow of colors and shades alternate, creating a constant emotional game

D



TECNOLOGIE PER IL RISPARMIO IDRICO ED ENERGETICO WATER AND ENERGY SAVING TECHNOLOGIES



**SURF ECO
PAG. 204**

AERATORE CON LIMITATORE DI PORTATA - AERATOR WITH FLOW LIMITER

A seconda del modello di aeratore che si sceglie di installare, il flusso d'acqua nella sua apertura massima può essere ridotto a 8, 6, 4 oppure 3 litri / minuto.

L'aeratore con limitazione di portata a 6 litri/minuto è installato di serie sui miscelatori della collezione SURF ECO (modificabile su richiesta al momento dell'ordine con le versioni a 8, 4 oppure 3 litri / minuto).

Depending on the model of aerator you choose to install, the water flow in its maximum opening can be reduced to 8, 6, 4 or 3 liters / minute.

The aerator with flow rate limitation to 6 liters / minute is installed as standard on the mixers of the SURF ECO collection (available on request at the time of order with the versions at 8, 4 or 3 liters / minute).



**SURF ECO
PAG. 204**

CARTUCCIA ECO ENERGY SAVING - ENERGY SAVING CARTRIDGE

La cartuccia ECO ENERGY SAVING evita la richiesta accidentale e involontaria di acqua calda, limitandone il consumo energetico alla sola necessità. Diversamente dalle cartucce standard, quando la leva è in posizione di riposo (allineata con la bocca del miscelatore) questa tecnologia prevede l'apertura solo in acqua fredda. Questa tecnologia è inclusa STANDARD nei miscelatori SURF-ECO.

The ECO ENERGY SAVING cartridge avoids any accidental and involuntary request for hot water, limiting this energy consumption to mere necessity. Unlike standard cartridges, when the lever is in the rest position (aligned with the mixer mouth) this technology only opens in cold water. This technology is included as STANDARD in SURF-ECO mixers.

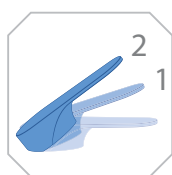

**SURF ECO
PAG. 204**

RISPARMIO IDRICO DINAMICO - WATER SAVING DYNAMIC

La tecnologia WATER SAVING DYNAMIC permette all'utente di scegliere la quantità di acqua realmente necessaria ad ogni operazione. Durante l'apertura, la leva si interrompe prima al 50% del flusso totale e richiede una seconda spinta volontaria per arrivare al 100% dell'erogazione. Questa tecnologia è disponibile come opzione nei miscelatori SURF-ECO.

The WATER SAVING DYNAMIC technology allows the user to choose the amount of water really needed for each operation. During opening, the lever first stops at 50% of the total flow and requires a second voluntary push to reach 100% of delivery. This technology is available on request for SURF-ECO mixers.

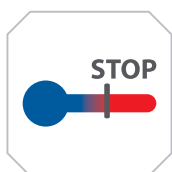

**SURF ECO
PAG. 204**

LIMITATORE DI TEMPERATURA - TEMPERATURE LIMITER

Indipendentemente dalla potenza dell'impianto, la tecnologia ANTISCALDING applicata sulla cartuccia riduce la temperatura massima dell'acqua erogata dal singolo miscelatore. Questa tecnologia evita le scottature, limita gli sprechi e garantisce un risparmio energetico costante nel tempo. Questa tecnologia è disponibile come opzione nei miscelatori SURF-ECO.

Regardless of the power of your system, the ANTISCALDING technology applied to the cartridge reduces the maximum temperature of the water supplied by each mixer. This technology avoids burns, limits waste and guarantees constant energy savings over time. This technology is available on request for SURF-ECO mixers



**AERATORI
AERATORS
PAG. 523**

AERATORE A RISPARMIO IDRICO - WATER SAVING AERATOR

Questa tipologia di aeratore produce una maggiore aerazione del flusso d'acqua, consentendo un risparmio idrico fino al 70% senza influire sulle prestazioni del prodotto. L'aeratore a risparmio idrico è acquistabile con il codice W002091800 e può essere installato su qualsiasi miscelatore per lavabo con misura M24. Di serie sui miscelatori per lavabo delle collezioni EDSENZA, ARTIC e MAXIMA

This type of aerator produces greater aeration of the water flow, allowing water savings of up to 70% without affecting the product performance. This water-saving aerator can be purchased with the code W002091800 and can be installed on any basin mixer with size M24. Standard equipment on basin mixers from ESSENZA, ARTIC and MAXIMA collections.



TECNOLOGIE PER GLI AMBIENTI PUBBLICI *PUBLIC ENVIRONMENTS TECHNOLOGIES*

Rubineria con sensore a infrarossi *Infrared sensor taps*

Elettroniche ad alto rendimento in grado di garantire un preciso controllo sui tempi di erogazione dell'acqua. L'attivazione tramite fotocellula è particolarmente consigliata nei luoghi pubblici ad alto passaggio per evitare che l'utilizzatore entri in contatto con il miscelatore, assicurando la massima igiene all'utenza e limitando gli sprechi di acqua.

High-performance electronics to guarantee a precise control over water flow dispensing times. The activation by photocell is particularly recommended in high-traffic public places as it prevents the user from coming into contact with the mixer, ensuring maximum hygiene for the users and reducing the waste of water.

Rubineria con flusso temporizzato *Timed flow taps*

TEMPOR TOUCH è una soluzione di temporizzazione elettronica dedicata agli ambienti pubblici e commerciali che richiedono un consumo idrico controllato.

La chiusura temporizzata elettronica permette di ridurre al minimo gli sprechi di acqua e di evitare il contatto con il miscelatore dopo l'igienizzazione delle mani, fornendo un'alternativa più precisa e funzionale alla temporizzazione meccanica.

La rubinetteria TEMPOR TOUCH integra un pulsante piezoelettrico che, tramite una leggera pressione, comanda l'avvio del flusso dell'acqua. L'erogazione dell'acqua termina dopo un periodo di tempo preimpostato oppure con una seconda pressione del tasto. Rubinetterie Mariani propone miscelatori a temporizzazione elettronica in diverse varianti dal design minimale e spiccatamente moderno.

TEMPOR TOUCH is an electronic temporized solution dedicated to those public and commercial environments that require a controlled water consumption. The electronic timed closure minimizes water waste and avoid any contact with the mixer after the hand sanitation, providing a more precise and functional alternative to mechanical timing.

The TEMPOR TOUCH faucet integrates a piezoelectric button which, by pressing lightly, controls the start of the water flow.

Water delivery ends after a preset range of time or with a second press of the same button. Rubinetterie Mariani offers electronic timing mixers in different variants with a minimal and distinctly modern design.



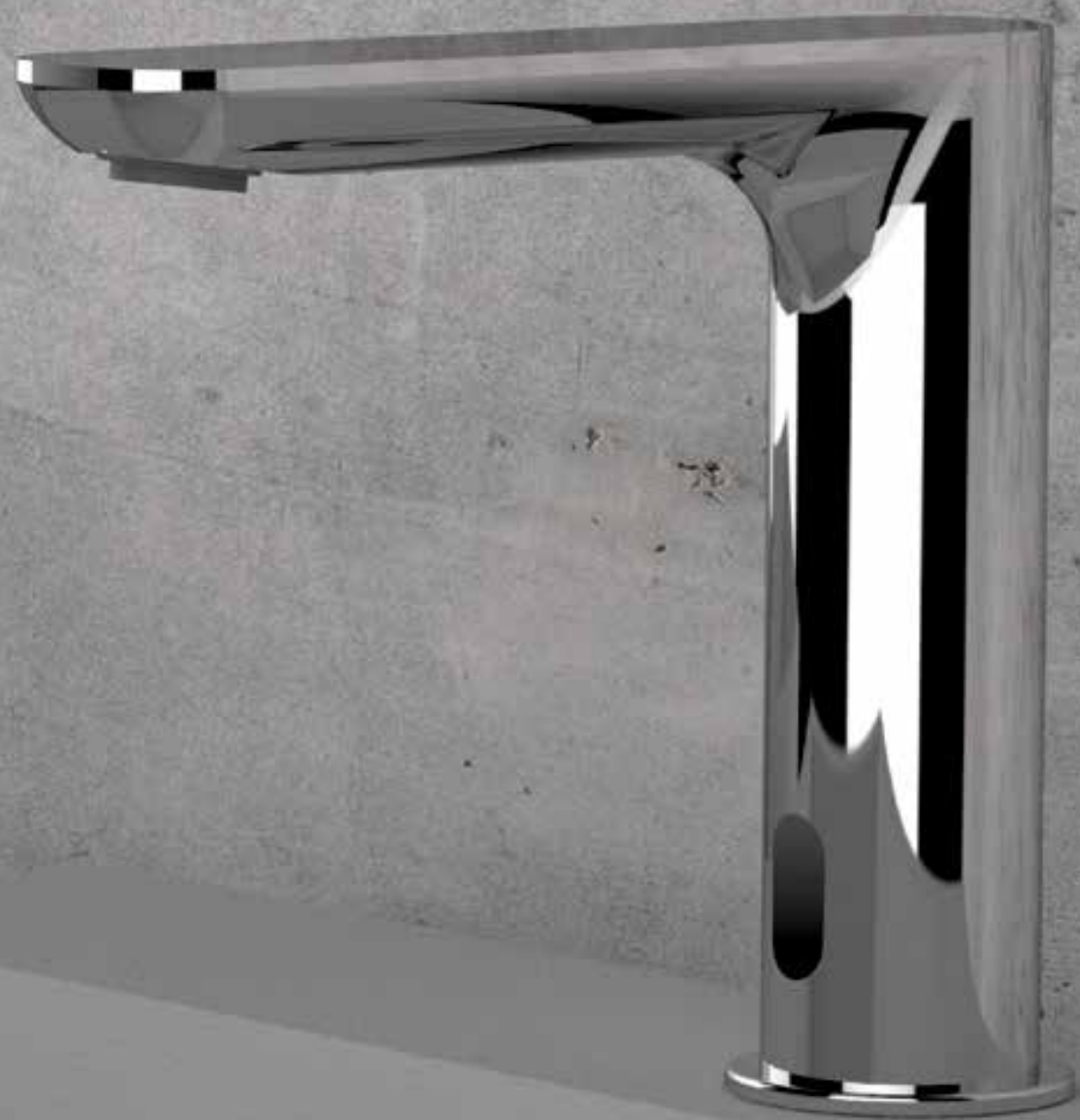

TECNOLOGIA IN CUCINA *TECHNOLOGY IN THE KITCHEN*

Miscelatori touch-me *Touch-me faucets*

TOUCH-ME è una tecnologia di ultima generazione che permette di aprire e chiudere il flusso dell'acqua al solo tocco del miscelatore, senza quindi dover impugnare la leva. Con i miscelatori per cucina TOUCH-ME di Rubinetterie Mariani è infatti possibile utilizzare il rubinetto della cucina anche con le mani impegnate o sporche, sarà sufficiente toccare la bocca del rubinetto con, ad esempio, l'avambraccio, il cucchiaino o il bordo della pentola.

La tecnologia TOUCH-ME prevede un'installazione salva-spazio sotto il lavabo ed è alimentata a batterie. La leva di miscelazione conserva intatte le sue funzioni di apertura, chiusura e regolazione della temperatura per l'utilizzo tradizionale. I miscelatori TOUCH-ME portano un valore di grande innovazione all'interno delle vostre cucine, per farvi vivere il cuore della casa con tutta la serenità, la praticità e la sicurezza che avete sempre sognato.

TOUCH-ME is a latest generation technology to open and close the water flow simply by touching the mixer, without therefore having to grip the lever. With the TOUCH-ME kitchen mixers by Rubinetterie Mariani it is in fact possible to open and close the water even with busy or dirty hands, simply by touching the tap's surface with, for example, the forearm, the spoon or the edge of the pot.

TOUCH-ME technology provides a space-saving installation under the sink and is battery powered. The mixing lever retains its opening, closing and temperature adjustment functions for traditional use. TOUCH-ME mixer faucets bring a value of great innovation to your kitchen interiors, to make you experience the heart of the house with all the serenity, practicality and safety you have always dreamed about.



TOUCH ME





MARATHI

Rubinetteria per acqua depurata

Faucets for purified water

Grazie alla rubinetteria per cucina a 3 o più ingressi è possibile gestire, direttamente dal miscelatore del lavello, anche l'erogazione dell'acqua proveniente da un depuratore. Rubinetterie Mariani mette a disposizione miscelatori per cucina con gestione degli ingressi acqua sia meccanica che elettronica per rendere questa operazione il più semplice ed efficace possibile. Tecnologie e materiali utilizzati preservano la qualità ed il sapore dell'acqua filtrata ed evitano le contaminazioni con quella miscelata. L'acqua non filtrata è sempre regolata tramite la leva di miscelazione secondo la modalità tradizionale e segue un percorso distinto per evitare qualsiasi contaminazione.

NOTE TECNICHE: Da collegare ad un apparecchio di depurazione di vostra scelta.

I modelli con gestione elettronica degli ingressi acqua richiedono un'alimentazione elettrica o a batterie.

The kitchen faucets with 3 or more entrances make it possible to manage, directly from the sink mixer, the supply of water from a purifier. Rubinetterie Mariani offers different kitchen mixers with both mechanical and electronic water inlet management to make this operation as simple and effective as possible. Selected technologies and materials preserve the quality and the flavor of filtered water and avoid contamination with mixed one. The unfiltered water is always regulated through the mixing lever according to the traditional method and follows a distinct path to avoid any contamination.

TECHNICAL NOTES: To be connected to a purification device of your choice.

Mixer models with electronic management of the water inlets require an electrical or battery power supply.

PURE WATER





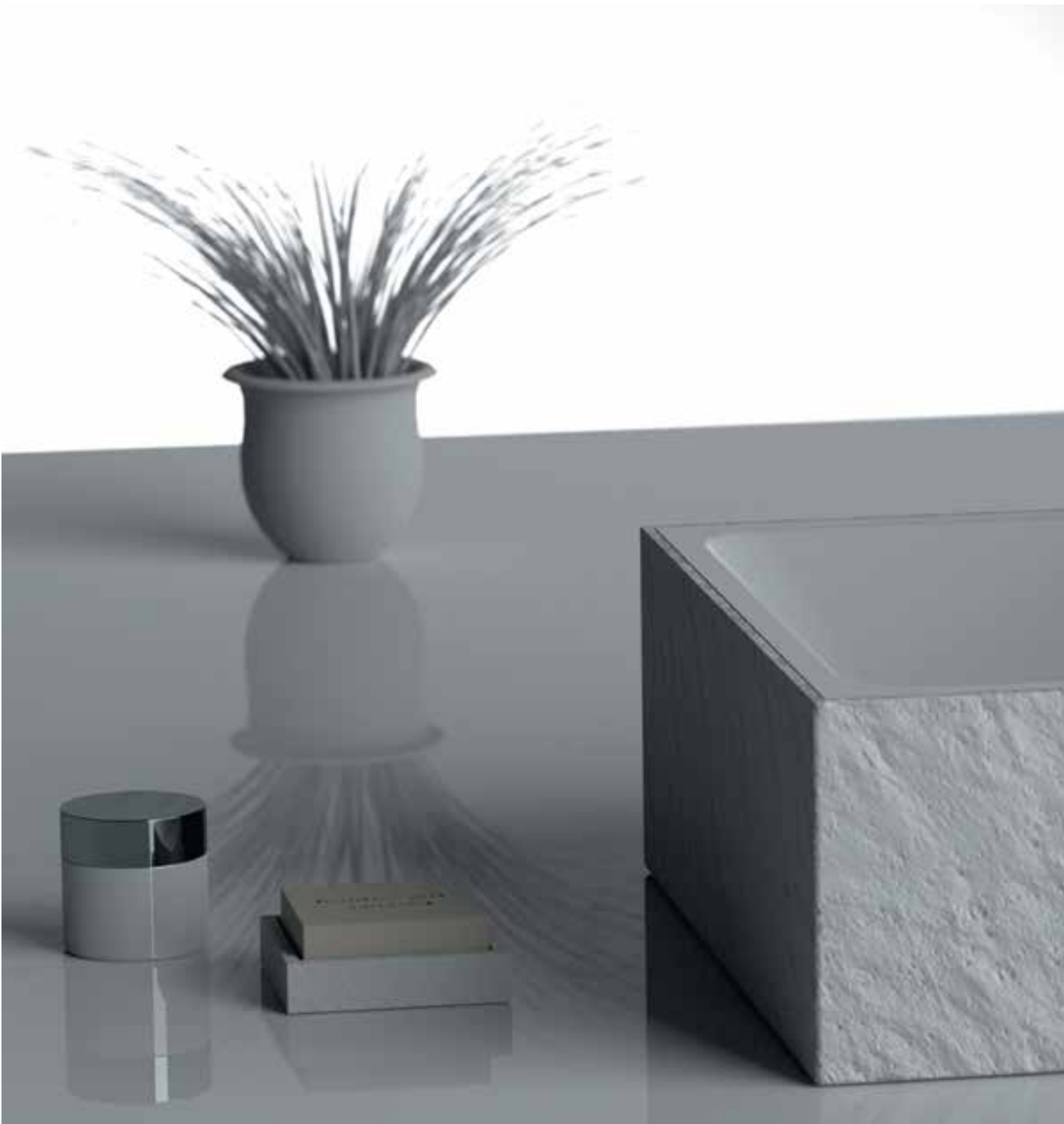



AVENUE

5TH AVENUE

ARMONIA

ULTRAMINIMAL

POLAR

NEXT

RIVER

STILNOVO

AVENUE





AVENUE è una collezione di rubinetteria monocomando dal forte impatto moderno ed essenziale.

Sviluppato intorno ad una cartuccia dal diametro di 25 mm, il design del miscelatore esprime un'innata eleganza e crea un perfetto accordo tra forme tondeggianti, superfici piane e linee squadrate. Il profilo estremamente sottile e lineare viene poi ulteriormente assottigliato dall'accentuarsi delle sfaccettature sulla bocca e dall'aeratore a scomparsa.

La collezione è dotata di cartuccia a dischi ceramici Ø 25 mm per lavabo e bidet e Ø 35 mm per incassi doccia.

AVENUE is a single-lever mixers collection with a strong modern and essential impact.

Developed around a 25 mm diameter cartridge, the design of the mixer expresses an innate elegance and creates a perfect harmony between rounded shapes, flat surfaces and squared lines. The extremely thin and linear profile is then further thinned by the faceting accentuation on the spout and by the concealed aerator.

The collection is equipped with ceramic disc cartridge, Ø 25 mm for basin and bidet and Ø 35 mm for shower mixer.

OPZIONI DI FINITURA

La collezione AVENUE è disponibile con 3 diverse opzioni di finitura, oltre al cromato: Nero Opaco (.14), Bianco Opaco (.37), Nichel Spazzolato (.08). Indicare il codice di finitura al momento dell'ordine.



AVENUE

FINISHING OPTIONS

AVENUE collection is available with 3 different finishing options, in addition to chrome: Matt Black (.14), Matt White (.37), Brushed Nickel (.08). Refer to the finishing code when ordering.



Nero Opaco
Matt Black

.14



Bianco Opaco
Matt White

.37



Nichel Spazzolato
Brushed Nickel

.08



393/AV



393AV

Miscelatore monocomando lavabo con scarico.
Single-lever basin mixer with pop-up waste.

CR

FIN (.14 .37 .08)



398AV

Miscelatore monocomando lavabo alto senza scarico.
High basin mixer without waste.

CR

FIN (.14 .37 .08)



380AV

Miscelatore monocomando lavabo senza scarico e senza foro sul corpo.
Single-lever basin mixer without waste and without body hole.

CR

FIN (.14 .37 .08)



305AV

Miscelatore monocomando lavabo due fori senza scarico.
Two holes single-lever basin mixer without waste.

CR

FIN (.14 .37 .08)

**565AV**

Miscelatore monocomando lavabo ad incasso, completo.
Built-in single-lever basin mixer, complete

CR

FIN (.14 .37 .08)

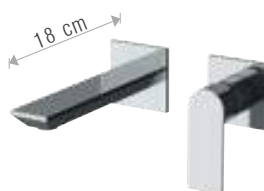
**565AVP**

Miscelatore monocomando a incasso per lavabo su doppia piastra, completo
Single-lever built-in basin mixer with double flanges, complete

CR

FIN (.14 .37 .08)

565AVE

Solo parte esterna
Only external component

CR

FIN (.14 .37 .08)

565AVINC

Solo parte incasso
Only built-in components

CR

FIN (.14 .37 .08)

565AVPE

Solo parte esterna
Only external component

CR

FIN (.14 .37 .08)

565AVINC

Solo parte incasso
Only built-in components

CR

FIN (.14 .37 .08)

**565AVL**

Miscelatore monocomando lavabo ad incasso, completo
Built-in single-lever basin mixer, complete

CR

FIN (.14 .37 .08)

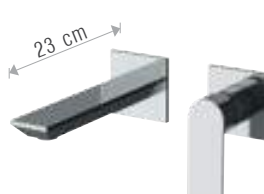
**565AVPL**

Miscelatore monocomando a incasso per lavabo su doppia piastra, completo
Single-lever built-in basin mixer with double flanges, complete.

CR

FIN (.14 .37 .08)

565AVLE

Solo parte esterna
Only external component

CR

FIN (.14 .37 .08)

565AVINC

Solo parte incasso
Only built-in components

CR

FIN (.14 .37 .08)

565AVPLE

Solo parte esterna
Only external component

CR

FIN (.14 .37 .08)

565AVINC

Solo parte incasso
Only built-in components

CR

FIN (.14 .37 .08)

**493AV**

Miscelatore monocomando bidet con scarico.
Single-lever bidet mixer with pop-up waste.

CR

FIN (.14 .37 .08)

480AV

Miscelatore monocomando bidet senza scarico con foro sul corpo.
Single-lever bidet mixer without waste with body hole.

CR

FIN (.14 .37 .08)

**185AVW**

Miscelatore incasso per shut-off comprensivo di doccetta shut-off, supporto doccia, presa acqua, su piastra in ottone cromato e flessibile doccia da 120 cm.
Built-in shut-off mixer set including shut-off handshower, connection pipe on flange, completely in c.p. brass and shower flexible 120 cm.

CR

FIN (.14 .37 .08)





AVENUE

5TH AVENUE

ARMONIA

ULTRAMINIMAL

POLAR

NEXT

RIVER

STILNOVO

565/AVL



230AV

Miscelatore monocomando vasca con accessori.
Bath mixer with accessories.

CR

FIN (.14 .37 .08)

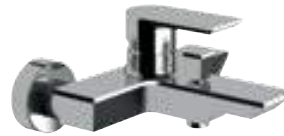

212AV

Miscelatore monocomando vasca senza set doccia.
Wall mtg. single-lever bath mixer without accessories.

CR

FIN (.14 .37 .08)



506AVC

Miscelatore monocomando lavello canna corta girevole.
Single-lever sink mixer with shorter swivel spout.

CR

FIN (.14 .37 .08)

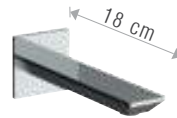

130AV

Bocca incasso.
Built-in spout.

CR

FIN (.14 .37 .08)



230/AVL

**179AV**

Miscelatore monocomando incasso, completo.
Concealed single-lever shower mixer, complete

CR

FIN (.14 .37 .08)

**173AV**

Miscelatore monocomando incasso con deviatore, completo.
Concealed single-lever shower mixer with diverter, complete.

CR

FIN (.14 .37 .08)

179AVE

Solo parte esterna
Only external component

CR

FIN (.14 .37 .08)

179INC35

Solo parte incasso
Only built-in components

CR

FIN (.14 .37 .08)

173AVE

Solo parte esterna
Only external component

CR

FIN (.14 .37 .08)

173INC35

Solo parte incasso
Only built-in components

CR

FIN (.14 .37 .08)

**173AVP2**

Miscelatore monocomando per doccia con deviatore a 2 vie su unica piastra, completo.
Single-lever built-in shower mixer with 2 ways diverter on single flange, complete.

CR

FIN (.14 .37 .08)

**173AVP3**

Miscelatore monocomando per doccia con deviatore a 3 vie su unica piastra, completo.
Single-lever built-in shower mixer with 3 ways diverter on single flange, complete.

CR

FIN (.14 .37 .08)

173AVP2E

Solo parte esterna
Only external component

CR

FIN (.14 .37 .08)

173INC2

Solo parte incasso
Only built-in components

CR

FIN (.14 .37 .08)

173AVP2E

Solo parte esterna
Only external component

CR

FIN (.14 .37 .08)

173INC3

Solo parte incasso
Only built-in components

CR

FIN (.14 .37 .08)

**173AVP4**

Miscelatore monocomando per doccia con deviatore a 4 vie su unica piastra.
Single-lever built-in shower mixer with 4 ways diverter on single flange.

CR

FIN (.14 .37 .08)

**173AVPP4**

Miscelatore monocomando per doccia con deviatore a 4 vie su doppia piastra.
Single-lever built-in shower mixer with 4 ways diverter on double flange.

CR

FIN (.14 .37 .08)

173AVP5

Miscelatore monocomando per doccia con deviatore a 5 vie su unica piastra.
Single-lever built-in shower mixer with 5 ways diverter on single flange.

CR

FIN (.14 .37 .08)

173AVPP5

Miscelatore monocomando per doccia con deviatore a 5 vie su doppia piastra.
Single-lever built-in shower mixer with 5 ways diverter on double flange.

CR

FIN (.14 .37 .08)



252AV

Miscelatore monocomando doccia senza accessori.
Wall mtg. single-lever shower mixer without accessories.

CR

FIN (.14 .37 .08)



254AV

Miscelatore monocomando doccia esterno con leva frontale, senza kit doccia.
Wall mounted single-lever shower mixer with front lever, without shower kit

CR

FIN (.14 .37 .08)



260AVAQX25

Colonna doccia a 3 vie composta da: miscelatore vasca/doccia con deviatore integrato nella bocca; soffione ultrapiatto 25x25 cm in acciaio INOX lucidato (SQ00425); colonna telescopica in ottone con altezza regolabile; doccetta rettangolare piatta a 1 funzione, in ottone (191D9); flessibile 150 cm.

3-way shower column including: bath/shower mixer with diverter integrated in the spout; 25x25 cm ultra-flat shower head in polished stainless steel (SQ00425); height-adjustable telescopic brass column; 1-function flat rectangular hand shower, in brass (191D9); 150 cm flexible hose.

CR



259AVAQX25

Colonna doccia composta da: miscelatore esterno con attacco superiore (259AV); soffione ultrapiatto 25x25 cm in acciaio INOX lucidato (SQ00425); colonna telescopica in ottone con altezza regolabile, deviatore; doccetta rettangolare piatta a 1 funzione, in ottone (191D9); flessibile 150 cm.

Shower column including: exposed mixer with upper connection (259AV); 25x25 cm ultra-flat shower head in polished stainless steel (SQ00425); height-adjustable telescopic brass column with diverter; 1-function flat rectangular hand shower, in brass (191D9); 150 cm flexible hose.

CR

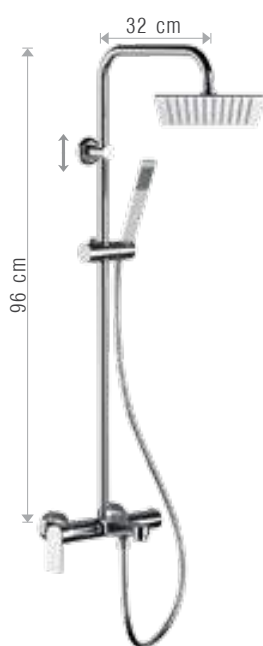

260AVXQX25

Colonna doccia a 3 vie composta da: miscelatore vasca/doccia con deviatore integrato nella bocca; soffione ultrapiatto 25x25 cm in acciaio INOX lucidato (SQ00425); colonna con fissaggio superiore scorrevole; doccetta rettangolare piatta a 1 funzione, in ottone (191D9); flessibile 150 cm.

3-way shower column including: bath/shower mixer with diverter integrated in the spout; 25x25 cm ultra-flat shower head in polished stainless steel (SQ00425); column with sliding upper fixing; 1-function flat rectangular hand shower, in brass (191D9); 150 cm flexible hose.

CR



259AVXQX25

Colonna doccia composta da: miscelatore esterno con attacco superiore (259AV); soffione ultrapiatto 25x25 cm in acciaio INOX lucidato (SQ00425); colonna con fissaggio superiore scorrevole, deviatore; doccetta rettangolare piatta a 1 funzione, in ottone (191D9); flessibile 150 cm.

Shower column including: exposed mixer with upper connection (259AV); 25x25 cm ultra-flat shower head in polished stainless steel (SQ00425); column with sliding upper fixing and diverter; 1-function flat rectangular hand shower, in brass (191D9); 150 cm flexible hose.

CR



AVENUE

5TH AVENUE

ARMONIA

ULTRAMINIMAL

POLAR

NEXT

RIVER

STILNOVO

17BAVP3SR003



Set doccia composto da: miscelatore a incasso con deviatore a 2 vie su unica piastra (173AVP2); soffione ultrapiatto 20x20 cm in acciaio INOX lucidato (SQ00420); braccio a parete in ottone 30 cm (BD00330); doccetta rettangolare piastra a 1 funzione, in ottone (191D9); presa acqua con supporto fisso (242PA); flessibile 150 cm.

Shower set including: built-in mixer with 2-way diverter on a single plate (173AVP2); 20x20 cm ultra-flat shower head in polished stainless steel (SQ00420); 30 cm brass wall arm (BD00330); 1-function flat rectangular hand shower, in brass (191D9); brass connection pipe with shower holder (242PA); 150 cm flexible hose.



Set doccia composto da: miscelatore a incasso con deviatore a 2 vie su unica piastra (173AVP2); soffione ultrapiatto 20x20 cm in acciaio INOX lucidato (SQ00420); braccio a parete in ottone 30 cm (BD00330); saliscendi piatto in ottone; doccetta rettangolare piastra a 1 funzione, in ottone (191D9); presa acqua a muro (752PA); flessibile 150 cm.

Shower set including: built-in mixer with 2-way diverter on a single plate (173AVP2); 20x20 cm ultra-flat shower head in polished stainless steel (SQ00420); 30 cm brass wall arm (BD00330); ultra-flat brass sliding rail; 1-function flat rectangular hand shower, in brass (191D9); wall connection pipe (752PA); 150 cm flexible hose.

17BAVP2QX20

con soffione doccia 20x20 cm. with shower head 20x20 cm.

17BAVP2QX25

con soffione doccia 25x25 cm. with shower head 25x25 cm.

17BAVP2QX30

con soffione doccia 30x30 cm. with shower head 30x30 cm.

17AAVP2QX20

con soffione doccia 20x20 cm. with shower head 20x20 cm.

17AAVP2QX25

con soffione doccia 25x25 cm. with shower head 25x25 cm.

17AAVP2QX30

con soffione doccia 30x30 cm. with shower head 30x30 cm.



17BAVP3SR003

Set doccia composto da: miscelatore a incasso con deviatore a 3 posizioni su piastra unica (173AVP3); soffione a parete 50x20 cm con 2 uscite: pioggia e cascata, in acciaio INOX lucidato (SR003); doccetta rettangolare piastra a 1 funzione, in ottone (191D9); presa acqua con supporto fisso (242PA); flessibile 150 cm. Shower set including: built-in mixer with 3-way diverter on a single plate (173AVP3); 50x20 cm wall shower head with 2 outlets: rain and waterfall, in polished stainless steel (SR003); 1-function flat rectangular hand shower, in brass (191D9); brass connection pipe with shower holder (242PA); 150 cm flexible hose.

CR



17AAVP3SR003

Set doccia composto da: miscelatore a incasso con deviatore a 3 posizioni su piastra unica (173AVP3); soffione a parete 50x20 cm con 2 uscite: pioggia e cascata, in acciaio INOX lucidato (SR003); saliscendi piatto in ottone; doccetta rettangolare piastra a 1 funzione, in ottone (191D9); presa acqua a muro (752PA); flessibile 150 cm.

Shower set including: built-in mixer with 3-way diverter on a single plate (173AVP3); 50x20 cm wall shower head with 2 outlets: rain and waterfall, in polished stainless steel (SR003); ultra-flat brass sliding rail; 1-function flat rectangular hand shower, in brass (191D9); wall connection pipe (752PA); 150 cm flexible hose.

CR



17BAVP3SR005

Come 17BAVP3SR003: As 17BAVP3SR003:

con soffione a parete 50x22 cm ultrapiatto con 2 uscite: pioggia e cascata, in acciaio INOX lucidato (SR005).

with 50x22 cm ultra-flat wall shower head with 2 outlets: rain and waterfall, in polished stainless steel (SR005).

CR



17AAVP3SR005

Come 17AAVP3SR003: As 17AAVP3SR003:

con soffione a parete 50x22 cm ultrapiatto con 2 uscite: pioggia e cascata, in acciaio INOX lucidato (SR005).

with 50x22 cm ultra-flat wall shower head with 2 outlets: rain and waterfall, in polished stainless steel (SR005).

CR

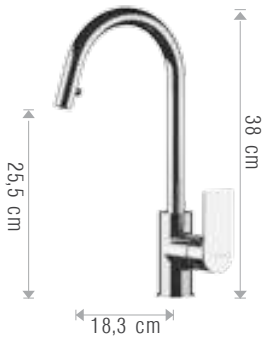
**584AV**

Miscelatore monocomando per lavello, con canna alta girevole e sistema di doccetta monofunzione estraibile.
Single-lever sink mixer with high swivel spout and 1-function pull-out hand shower.

CR

FIN (.14 .37 .08)

**585AV**

Miscelatore monocomando per lavello con canna alta girevole e doccetta estraibile a due funzioni.
Single-lever sink mixer with high movable spout and 2-functions pull-out hand shower.

CR

**506AV**

Miscelatore monocomando lavello, bocca girevole alta.
Single-lever sink mixer with swivel high spout.

CR

FIN (.14 .37 .08)

**581AV**

Miscelatore monocomando per lavello, con canna alta girevole e doccetta estraibile con impugnatura a martello a due funzioni.
Single-lever sink mixer with high swivel spout and 2-functions pull-out "hammer shaped" handle hand shower.

CR

**506AVQ**

Miscelatore monocomando per lavello, con bocca alta girevole a "U".
Single lever kitchen mixer with high swivel "U" spout.

CR

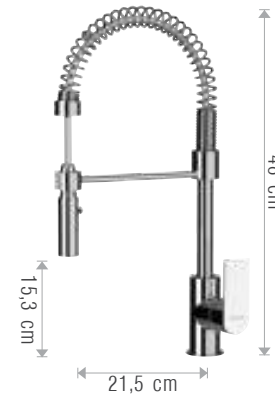
**57DAV**

Miscelatore monocomando lavello a molla con doccetta estraibile a 2 funzioni.
Single-lever sink mixer with spring spout and 2-functions pull-out handshower.

CR

**518AV1**

Miscelatore monocomando lavello con flessibile rivestito in tubo gomma soft-touch nero opaco.
Single-lever sink mixer with flexible hose coated in soft-touch matt black rubber pipe.

CR

**505AVB**

Miscelatore monocomando a parete per lavello, bocca girevole alta.
Wall mounting single-lever sink mixer with swivel high spout.

CR

FIN (.14 .37 .08)

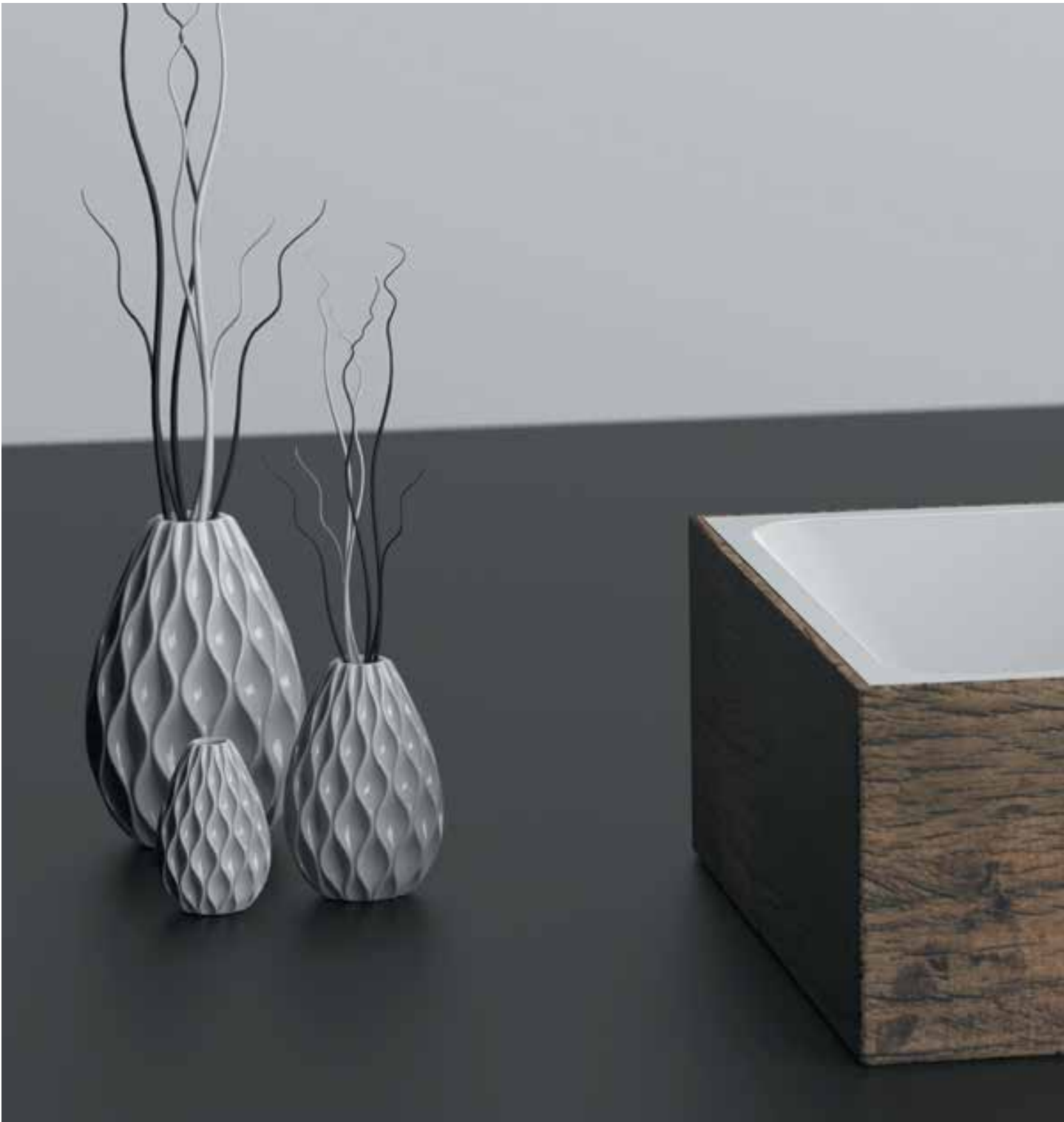



AVENUE

5TH AVENUE

ARMONIA

ULTRAMINIMAL

POLAR

NEXT

RIVER

STILNOVO

5TH AVENUE



5TH AVENUE è una collezione di miscelatori monocomando che celebra il dettaglio creativo, suggerendo diverse soluzioni di personalizzazione dall'estro delicato ed essenziale.

La leva del miscelatore è disponibile a scelta sia in una versione "standard" dal gusto estremamente minimale che in una versione "design" intarsiata da eleganti motivi lineari.

Le opzioni di finitura e le combinazioni tra diverse finiture di 5th AVENUE creano ulteriori elementi di unicità nei progetti di arredo bagno.

La collezione è dotata di cartuccia a dischi ceramici Ø 25 mm per lavabo e bidet e Ø 35 mm per incassi doccia.

5TH AVENUE is a single-lever mixer collection that celebrates the creative detail, suggesting various customization solutions with a delicate and essential flair.

The mixer lever is optionally available both in a "standard" version with an extremely minimal taste and in a "design" version inlaid with elegant linear motifs.

The finishing options and combinations of different finishes of 5th AVENUE create additional elements of uniqueness for bathroom interior design.

The collection is equipped with ceramic disc cartridge, Ø 25 mm for basin and bidet and Ø 35 mm for shower mixer.



 OPZIONI DI FINITURA

La collezione 5TH AVENUE è disponibile con 3 diverse opzioni di finitura, oltre al cromato: Nero Opaco (.14), Bianco Opaco (.37), Nichel Spazzolato (.08). Il corpo cromato può inoltre essere abbinato a una leva in nero opaco o bianco opaco. Indicare il codice di finitura al momento dell'ordine.



Nero Opaco
Matt Black

.14



Bianco Opaco
Matt White

.37



Nichel Spazzolato
Brushed Nickel

.08

FINITURA - FINISHING: A

FINISHING OPTIONS

5th AVENUE collection is available with 3 different finishing options, in addition to chrome: Matt Black (.14), Matt White (.37), Brushed Nickel (.08). The chromed body can also be combined with a matt black or matt white lever. Refer to the finishing code when ordering.



Corpo Cromo / Maniglia Nero Opaco
Chrome Body / Matt Black Lever

.LN



Corpo Cromo / Maniglia Bianco Opaco
Chrome Body / Matt White Lever

.LB

FINITURA - FINISHING: B

AVENUE

5th AVENUE

ARMONIA

ULTRAMINIMAL

POLAR

NEXT

RIVER

STILNOVO

MANIGLIE DISPONIBILI

Personalizza la tua rubinetteria scegliendo la leva e la colorazione di finitura più adatte al tuo stile di arredo.



5TH AVENUE

LEVERS AVAILABLE

Customize your faucets by choosing the lever and the finishing color that best suit your style of furnishing.



.AV5



.AV6



.AV7

STANDARD

DESIGN

AVENUE

5TH AVENUE

ARMONIA

ULTRAMINIMAL

POLAR

NEXT

RIVER

STILNOVO







565AV5

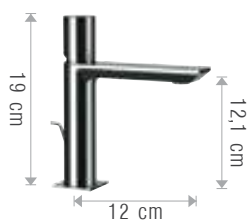

393AV5

Miscelatore monocomando lavabo con scarico.
Single-lever basin mixer with pop-up waste.

- CR
- FIN A (.14 .37 .08)
- FIN B (.LN .LB)
- DESIGN .AV6 .AV7
- CR
- FIN A (.14 .37 .08)
- FIN B (.LN .LB)



398AV5

Miscelatore monocomando lavabo alto senza scarico.
High basin mixer without waste.

- CR
- FIN A (.14 .37 .08)
- FIN B (.LN .LB)
- DESIGN .AV6 .AV7
- CR
- FIN A (.14 .37 .08)
- FIN B (.LN .LB)



380AV5

Miscelatore monocomando lavabo senza scarico e senza foro sul corpo.
Single-lever basin mixer without waste and without body hole.

- CR
- FIN A (.14 .37 .08)
- FIN B (.LN .LB)
- DESIGN .AV6 .AV7
- CR
- FIN A (.14 .37 .08)
- FIN B (.LN .LB)



305AV5

Miscelatore monocomando lavabo due fori senza scarico.
Two holes single-lever basin mixer without waste.

- CR
- FIN A (.14 .37 .08)
- FIN B (.LN .LB)

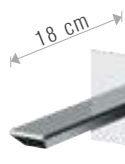
**565AV5**

Miscelatore monocomando lavabo ad incasso, completo.
Built-in single-lever basin mixer, complete.

CR
FIN A (.14 .37 .08)
FIN B (.LN .LB)
DESIGN .AV6 .AV7
CR
FIN A (.14 .37 .08)
FIN B (.LN .LB)

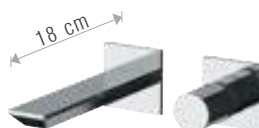
**565AV5P**

Miscelatore monocomando a incasso per lavabo su doppia piastra, completo
Single-lever built-in basin mixer with double flanges, complete.

CR
FIN A (.14 .37 .08)
FIN B (.LN .LB)
DESIGN .AV6 .AV7
CR
FIN A (.14 .37 .08)
FIN B (.LN .LB)

565AV5E

Solo parte esterna
Only external component

CR
FIN A (.14 .37 .08)
FIN B
DESIGN .AV6 .AV7
CR
FIN A
FIN B

565AVINC

Solo parte incasso
Only built-in components

CR
FIN A (.14 .37 .08)

565AV5PE

Solo parte esterna
Only external component

CR
FIN A (.14 .37 .08)
FIN B
DESIGN .AV6 .AV7
CR
FIN A
FIN B

565AVINC

Solo parte incasso
Only built-in components

CR
FIN A (.14 .37 .08)

**565AV5L**

Miscelatore monocomando lavabo ad incasso.
Built-in single-lever basin mixer.

CR
FIN A (.14 .37 .08)
FIN B (.LN .LB)
DESIGN .AV6 .AV7
CR
FIN A (.14 .37 .08)
FIN B (.LN .LB)

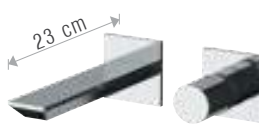
**565AV5PL**

Miscelatore monocomando a incasso per lavabo su doppia piastra.
Single-lever built-in basin mixer with double flanges.

CR
FIN A (.14 .37 .08)
FIN B (.LN .LB)
DESIGN .AV6 .AV7
CR
FIN A (.14 .37 .08)
FIN B (.LN .LB)

565AV5LE

Solo parte esterna
Only external component

CR
FIN A (.14 .37 .08)
FIN B
DESIGN .AV6 .AV7
CR
FIN A
FIN B

565AVINC

Solo parte incasso
Only built-in components

CR
FIN A (.14 .37 .08)

565AV5PLE

Solo parte esterna
Only external component

CR
FIN A (.14 .37 .08)
FIN B
DESIGN .AV6 .AV7
CR
FIN A
FIN B

565AVINC

Solo parte incasso
Only built-in components

CR
FIN A (.14 .37 .08)

**493AV5**

Miscelatore monocomando bidet con scarico.
Single-lever bidet mixer with pop-up waste.

CR
FIN A (.14 .37 .08)
FIN B (.LN .LB)
DESIGN .AV6 .AV7
CR
FIN A (.14 .37 .08)
FIN B (.LN .LB)

**480AV5**

Miscelatore monocomando bidet senza scarico con foro sul corpo.
Single-lever bidet mixer without waste with body hole.

CR
FIN A (.14 .37 .08)
FIN B (.LN .LB)
DESIGN .AV6 .AV7
CR
FIN A (.14 .37 .08)
FIN B (.LN .LB)

**185AV5W**

Miscelatore incasso per shut-off comprensivo di doccetta shut-off, supporto doccia, presa acqua, su piastra, in ottone cromato e flessibile doccia da 120 cm.
Built-in shower mixer set including shut-off handshower, connection pipe on flange, completely in c.p. brass and shower flexible 120 cm.

CR
FIN A (.14 .37 .08)
FIN B (.LN .LB)

**212AV5**

Miscelatore monocomando vasca senza Set doccia.
Wall mtg. single-lever bath mixer without accessories.

CR
FIN A (.14 .37 .08)
FIN B (.LN .LB)

**230AV5**

Miscelatore monocomando vasca con accessori.
Bath mixer with accessories.

CR
FIN A (.14 .37 .08)
FIN B (.LN .LB)

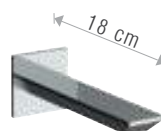
**130AV**

Bocca incasso.
Built-in spout.

CR
FIN A (.14 .37 .08)

**252AV5**

Miscelatore monocomando doccia senza accessori.
Wall mtg. single-lever shower mixer without accessories.

CR
FIN A (.14 .37 .08)
FIN B (.LN .LB)

**254AV5**

Miscelatore doccia esterno per colonna doccia con attacco superiore da 3/4".
External shower single-lever mixer with 3/4" upper connection.

CR
FIN A (.14 .37 .08)
FIN B (.LN .LB)

**179AV5**

Miscelatore monocomando incasso, completo.
Concealed single-lever shower mixer, complete.

CR

FIN A (.14 .37 .08)

FIN B (.LN .LB)

**173AV5**

Miscelatore monocomando incasso con deviatore, completo.
Concealed single-lever shower mixer with diverter, complete.

CR

FIN A (.14 .37 .08)

FIN B (.LN .LB)

179AV5E

Solo parte esterna
Only external component

CR

FIN A (.14 .37 .08)

565AVINC

Solo parte incasso
Only built-in components

CR

FIN A (.14 .37 .08)

173AV5E

Solo parte esterna
Only external component

CR

FIN A (.14 .37 .08)

565AVINC

Solo parte incasso
Only built-in components

CR

FIN A (.14 .37 .08)

**173AV5P2**

Miscelatore monocomando per doccia con deviatore a 2 vie su unica piastra, completo.
Single-lever built-in shower mixer with 2 ways diverter on single flange, complete.

CR

FIN A (.14 .37 .08)

FIN B (.LN .LB)

**173AV5P3**

Miscelatore monocomando per doccia con deviatore a 3 vie su unica piastra, completo.
Single-lever built-in shower mixer with 3 ways diverter on single flange, complete.

CR

FIN A (.14 .37 .08)

FIN B (.LN .LB)

173AV5P2E

Solo parte esterna
Only external component

CR

FIN A (.14 .37 .08)

565AVINC

Solo parte incasso
Only built-in components

CR

FIN A (.14 .37 .08)

173AV5P2E

Solo parte esterna
Only external component

CR

FIN A (.14 .37 .08)

565AVINC

Solo parte incasso
Only built-in components

CR

FIN A (.14 .37 .08)

**173AV5P4**

Miscelatore monocomando per doccia con deviatore a 4 vie su unica piastra.
Single-lever built-in shower mixer with 4 ways diverter on single flange.

CR

FIN A (.14 .37 .08)

FIN B (.LN .LB)

**173AV5PP4**

Miscelatore monocomando per doccia con deviatore a 4 vie su doppia piastra.
Single-lever built-in shower mixer with 4 ways diverter on double flange.

CR

FIN A (.14 .37 .08)

FIN B (.LN .LB)

**173AV5P5**

Miscelatore monocomando per doccia con deviatore a 5 vie su unica piastra.
Single-lever built-in shower mixer with 5 ways diverter on single flange.

CR

FIN A (.14 .37 .08)

FIN B (.LN .LB)

173AV5PP5

Miscelatore monocomando per doccia con deviatore a 5 vie su doppia piastra.
Single-lever built-in shower mixer with 5 ways diverter on double flange.

CR

FIN A (.14 .37 .08)

FIN B (.LN .LB)

INCASSI TERMOSTATICI - THERMOSTATIC BUILT-IN MIXERS

**126AV5P2**

Miscelatore **termostatico** per doccia con deviatore a 2 posizioni su unica piastra. Portata a 3 Bar.

Thermostatic built-in shower mixer with 2 positions diverter on single flange. Flow rate at 3 Bar.

CR

FIN A (.14 .37 .08)

FIN B (.LN .LB)

**126AV5P3**

Miscelatore **termostatico** per doccia con deviatore a 3 vie su unica piastra. Portata a 3 Bar.

Thermostatic built-in shower mixer with 3 ways diverter on single flange. Flow rate at 3 Bar.

CR

FIN A (.14 .37 .08)

FIN B (.LN .LB)

**126AV5P4**

Miscelatore **termostatico** per doccia con deviatore a 4 posizioni su unica piastra. Portata a 3 Bar.

Thermostatic built-in shower mixer with 4 positions diverter on single flange. Flow rate at 3 Bar.

CR

FIN A (.14 .37 .08)

FIN B (.LN .LB)

**126AV5P5**

Miscelatore **termostatico** per doccia con deviatore a 5 posizioni su unica piastra. Portata a 3 Bar.

Thermostatic built-in shower mixer with 5 positions diverter on single flange. Flow rate at 3 Bar.

CR

FIN A (.14 .37 .08)

FIN B (.LN .LB)

**260AV5AQX25**

Colonna doccia a 3 vie composta da: miscelatore vasca/doccia con deviatore integrato nella bocca; soffione ultrapiatto 25x25 cm in acciaio INOX lucidato (SQ00425); colonna telescopica in ottone con altezza regolabile; doccetta rettangolare piatta a 1 funzione, in ottone (191D9); flessibile 150 cm.

3-way shower column including: bath/shower mixer with diverter integrated in the spout; 25x25 cm ultra-flat shower head in polished stainless steel (SQ00425); height-adjustable telescopic brass column; 1-function flat rectangular hand shower, in brass (191D9); 150 cm flexible hose.

CR

**259AV5AQX25**

Colonna doccia composta da: miscelatore esterno con attacco superiore (259AV); soffione ultrapiatto 25x25 cm in acciaio INOX lucidato (SQ00425); colonna telescopica in ottone con altezza regolabile, deviatore; doccetta rettangolare piatta a 1 funzione, in ottone (191D9); flessibile 150 cm.

Shower column including: exposed mixer with upper connection (259AV); 25x25 cm ultra-flat shower head in polished stainless steel (SQ00425); height-adjustable telescopic brass column with diverter; 1-function flat rectangular hand shower, in brass (191D9); 150 cm flexible hose.

CR

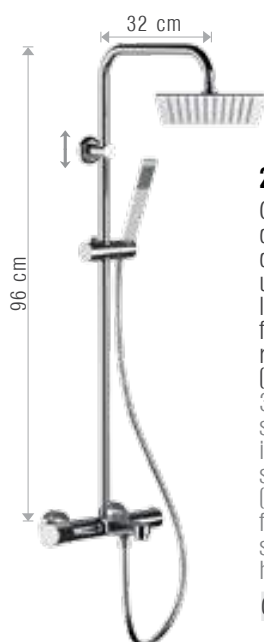
**260AV5XQX25**

Colonna doccia a 3 vie composta da: miscelatore vasca/doccia con deviatore integrato nella bocca; soffione ultrapiatto 25x25 cm in acciaio INOX lucidato (SQ00425); colonna con fissaggio superiore scorrevole; doccetta rettangolare piatta a 1 funzione, in ottone (191D9); flessibile 150 cm.

3-way shower column including: bath/shower mixer with diverter integrated in the spout; 25x25 cm ultra-flat shower head in polished stainless steel (SQ00425); column with sliding upper fixing; 1-function flat rectangular hand shower, in brass (191D9); 150 cm flexible hose.

CR

**259AV5XQX25**

Colonna doccia composta da: miscelatore esterno con attacco superiore (259AV); soffione ultrapiatto 25x25 cm in acciaio INOX lucidato (SQ00425); colonna con fissaggio superiore scorrevole, deviatore; doccetta rettangolare piatta a 1 funzione, in ottone (191D9); flessibile 150 cm.

Shower column including: exposed mixer with upper connection (259AV); 25x25 cm ultra-flat shower head in polished stainless steel (SQ00425); column with sliding upper fixing and diverter; 1-function flat rectangular hand shower, in brass (191D9); 150 cm flexible hose.

CR



Set doccia composto da: miscelatore con deviatore a 2 vie su piastre separate (176UMPP2); soffione ultrapiatto 20x20 cm in acciaio INOX lucidato (SQ00420); braccio a parete in ottone 30 cm (BD00330); doccetta rettangolare piatta a 1 funzione, in ottone (191D9); presa acqua a muro con supporto (242MNB); flessibile 150 cm.



Shower set including: built-in mixer with 2-way diverter on double plate (176UMPP2); 20x20 cm ultra-flat shower head in polished stainless steel (SQ00420); 30 cm brass wall arm (BD00330); 1-function flat rectangular hand shower, in brass (191D9); wall connection pipe with shower holder (242MNB); 150 cm flexible hose.

17CAV5QX20

con soffione doccia 20x20 cm.
with shower head 20x20 cm.

17CAV5QX25

con soffione doccia 25x25 cm.
with shower head 25x25 cm.

17CAV5QX30

con soffione doccia 30x30 cm.
with shower head 30x30 cm.

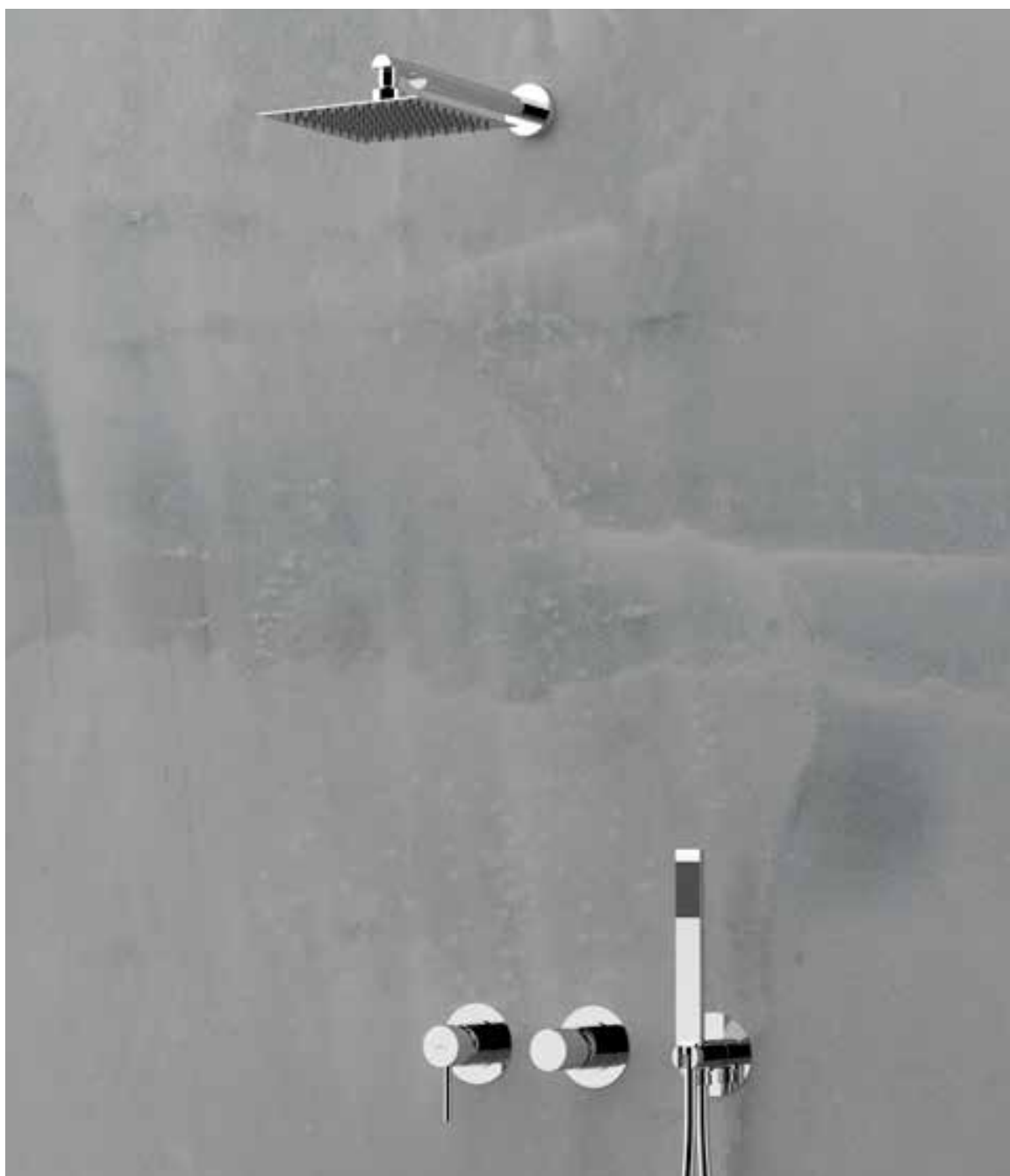

17CAV5QX20



Set doccia composto da: miscelatore a incasso con deviatore a 2 vie su piastra unica (173AV5P2); soffione ultrapiatto 20x20 cm in acciaio INOX lucidato (SQ00420); braccio a parete in ottone 30 cm (BD00330); doccetta rettangolare piatta a 1 funzione, in ottone (191D9); presa acqua con supporto fisso (242PA); flessibile 150 cm.

Shower set including: built-in mixer with 2-way diverter on a single plate (173AV5P2); 20x20 cm ultra-flat shower head in polished stainless steel (SQ00420); 30 cm brass wall arm (BD00330); 1-function flat rectangular hand shower, in brass (191D9); brass connection pipe with shower holder (242PA); 150 cm flexible hose.



Set doccia composto da: miscelatore a incasso con deviatore a 2 vie su piastra unica (173AV5P2); soffione ultrapiatto 20x20 cm in acciaio INOX lucidato (SQ00420); braccio a parete in ottone 30 cm (BD00330); saliscendi piatto in ottone; doccetta rettangolare piatta a 1 funzione, in ottone (191D9); presa acqua a muro (752PA); flessibile 150 cm.

Shower set including: built-in mixer with 2-way diverter on a single plate (173AV5P2); 20x20 cm ultra-flat shower head in polished stainless steel (SQ00420); 30 cm brass wall arm (BD00330); ultra-flat brass sliding rail; 1-function flat rectangular hand shower, in brass (191D9); wall connection pipe (752PA); 150 cm flexible hose.

17BAV5P2QX20

con soffione doccia 20x20 cm.
with shower head 20x20 cm.

17BAV5P2QX25

con soffione doccia 25x25 cm.
with shower head 25x25 cm.

17BAV5P2QX30

con soffione doccia 30x30 cm.
with shower head 30x30 cm.

17AAV5P2QX20

con soffione doccia 20x20 cm.
with shower head 20x20 cm.

17AAV5P2QX25

con soffione doccia 25x25 cm.
with shower head 25x25 cm.

17AAV5P2QX30

con soffione doccia 30x30 cm.
with shower head 30x30 cm.

**17BAV5P3SR003**

Set doccia composto da: miscelatore a incasso con deviatore a tre vie su piastra unica (173AV5P3); soffione a parete 50x20 cm con 2 uscite: pioggia e cascata, in acciaio INOX lucidato (SR003); doccetta rettangolare piatta a 1 funzione, in ottone (191D9); presa acqua a muro con supporto fisso (242MN); flessibile 150 cm.

Shower set including: built-in mixer with 3-way diverter on a single plate (173AV5P3); 50x20 cm wall shower head with 2 outlets: rain and waterfall, in polished stainless steel (SR003); 1-function flat rectangular hand shower, in brass (191D9); wall connection pipe with shower holder (242MN); 150 cm flexible hose.

CR

**17AAV5P3SR003**

Set doccia composto da: miscelatore a incasso con deviatore a tre vie su piastra unica (173AV5P3); soffione a parete 50x20 cm con 2 uscite: pioggia e cascata, in acciaio INOX lucidato (SR003); saliscendi piatto in ottone; doccetta rettangolare piatta a 1 funzione, in ottone (191D9); presa acqua a muro (752PA); flessibile 150 cm.

Shower set including: built-in mixer with 3-way diverter on a single plate (173AV5P3); 50x20 cm wall shower head with 2 outlets: rain and waterfall, in polished stainless steel (SR003); ultra-flat brass sliding rail; 1-function flat rectangular hand shower, in brass (191D9); wall connection pipe (752PA); 150 cm flexible hose.

CR

**17BAV5P3SR005**

Come 17BAV5P3SR003:
As 17BAV5P3SR003:

con soffione a parete 50x22 cm ultrapiatto con 2 uscite: pioggia e cascata, in acciaio INOX lucidato (SR005).
with 50x22 cm ultra-flat wall shower head with 2 outlets: rain and waterfall, in polished stainless steel (SR005).

CR

**17AAV5P3SR005**

Come 17AAV5P3SR003:
As 17AAV5P3SR003:

con soffione a parete 50x22 cm ultrapiatto con 2 uscite: pioggia e cascata, in acciaio INOX lucidato (SR005).
with 50x22 cm ultra-flat wall shower head with 2 outlets: rain and waterfall, in polished stainless steel (SR005).

CR





AVENUE

5TH AVENUE

ARMONIA

ULTRAMINIMAL

POLAR

NEXT

RIVER

STILNOVO

ARMONIA





Le forme della collezione di miscelatori ARMONIA si compongono di linee morbide ed armoniche.

Un design delicato che ben si abbina ad ambienti classici, pur sviluppandosi su una struttura tecnica di grande modernità: cartuccia di nuova concezione, totale invisibilità dell'aeratore, basetta integrata nella fusione del corpo lavabo.

La collezione è dotata di cartuccia Ø 35 mm Hydromignon by STSR.

The shapes of the ARMONIA mixer faucet collection are made up of soft and harmonious lines.

An elegant design that well matches with classic interiors, while developing on a highly modern technical details: a newly developed cartridge, a totally invisible aerator, the base completely integrated into the body fusion.

The collection is equipped with Hydromignon Ø 35 mm cartridge by STSR.

OPZIONI DI FINITURA

La collezione ARMONIA è disponibile con 2 diverse opzioni di finitura, oltre al cromato: Nero Opaco (.14), Nichel Spazzolato (.08). Indicare il codice di finitura al momento dell'ordine.



ARMONIA

FINISHING OPTIONS

ARMONIA collection is available with 2 different finishing options, in addition to chrome: Matt Black (.14), Brushed Nickel (.08). Refer to the finishing code when ordering.



Nero Opaco
Matt Black

.14



Nichel Spazzolato
Brushed Nickel

.08

AVENUE

5TH AVENUE

ARMONIA

ULTRAMINIMAL

POLAR

NEXT

RIVER

STILNOVO

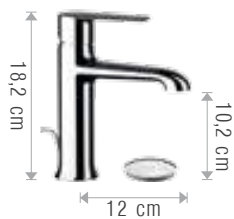

393AR
 Miscelatore monocomando lavabo con scarico.
 Single-lever basin mixer with pop-up waste.
 CR
 FIN (.14 .08)



398AR
 Miscelatore monocomando lavabo alto senza scarico.
 High basin mixer without waste.
 CR
 FIN (.14 .08)

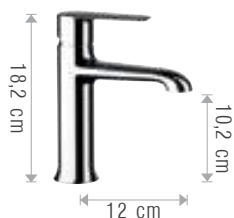

380AR
 Miscelatore monocomando lavabo senza scarico e senza foro sul corpo.
 Single-lever basin mixer without waste and without body hole.
 CR
 FIN (.14 .08)



305AR
 Miscelatore monocomando lavabo due fori senza scarico.
 Two holes single-lever basin mixer without waste.
 CR
 FIN (.14 .08)



**565AR**

Miscelatore monocomando lavabo ad incasso, completo.
Built-in single-lever basin mixer, complete.

CR

FIN (.14 .08)

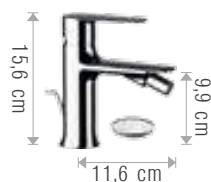
**493AR**

Miscelatore monocomando bidet con scarico.
Single-lever bidet mixer with pop-up waste.

CR

FIN (.14 .08)

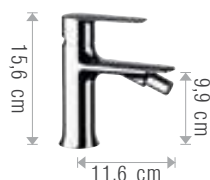
**480AR**

Miscelatore monocomando bidet senza scarico con foro sul corpo.
Single-lever bidet mixer without waste with body hole.

CR

FIN (.14 .08)

565ARE

Solo parte esterna
Only external component

CR

FIN (.14 .08)

565ARINC

Solo parte incasso
Only built-in components

CR

FIN (.14 .08)

**230AR**

Miscelatore monocomando vasca con accessori.
Bath mixer with accessories.

CR

**212AR**

Miscelatore monocomando vasca senza accessori.
Wall mtg. single-lever bath mixer without accessories.

CR

FIN (.14 .08)



398AR



179AR

Miscelatore monocomando incasso, completo.
Concealed single-lever shower mixer, complete.

CR
FIN (.14 .08)



173AR

Miscelatore monocomando incasso con deviatore, completo.
Concealed single-lever shower mixer with diverter, complete.

CR
FIN (.14 .08)

179ARE

Solo parte esterna
Only external component

CR
FIN (.14 .08)

179INC35

Solo parte incasso
Only built-in components

CR
FIN (.14 .08)

173ARE

Solo parte esterna
Only external component

CR
FIN (.14 .08)

173INC35

Solo parte incasso
Only built-in components

CR
FIN (.14 .08)



173ARP2

Miscelatore monocomando incasso con deviatore a 2 vie, completo.
Concealed single-lever shower mixer with 2 ways diverter, complete.

CR
FIN (.14 .08)



173ARP3

Miscelatore monocomando incasso con deviatore a 3 vie, completo.
Concealed single-lever shower mixer with 3 ways diverter, complete.

CR
FIN (.14 .08)

173ARP2E

Solo parte esterna
Only external component

CR
FIN (.14 .08)

173INCP2

Solo parte incasso
Only built-in components

CR
FIN (.14 .08)

173ARP2E

Solo parte esterna
Only external component

CR
FIN (.14 .08)

173INCP3

Solo parte incasso
Only built-in components

CR
FIN (.14 .08)



252AR

Miscelatore monocomando doccia senza accessori.
Wall mtg. single-lever shower mixer without accessories.

CR
FIN (.14 .08)



185ARW

Miscelatore incasso per shut-off comprensivo di doccetta shut-off, supporto doccia, presa acqua, su piastra in ottone cromato e flessibile doccia ad 120 cm.
Built-in shower mixer set including shut-off handshower, connection pipe on flange, completely in c.p. brass and shower flexible 120 cm.

CR
FIN (.14 .08)

**259ARADX25**

Colonna doccia composta da: miscelatore esterno con attacco alto da 3/4" (259AR); soffione ultrapiatto 25x25 cm con angoli arrotondati in acciaio INOX lucidato (SD00125); colonna telescopica in ottone con altezza regolabile, deviatore; doccetta a 4 funzioni con pulsante per il cambio dei getti, in abs, anticalcare (191D8); flessibile 150 cm.

Shower column including: exposed mixer with 3/4" upper connection (259AR); 25x25 cm ultra-flat shower head with rounded corners in polished stainless steel (SD00125); height-adjustable telescopic brass column with diverter; 4-function hand shower with button for changing the jets, in abs, anti-limescale (191D8); 150 cm flexible hose.

CR

**260ARADX25**

Colonna doccia a 3 vie composta da: miscelatore vasca/doccia con deviatore integrato nella bocca; soffione ultrapiatto 25x25 cm con angoli arrotondati in acciaio INOX lucidato (SD00125); colonna telescopica in ottone con altezza regolabile; doccetta a 4 funzioni con pulsante per il cambio dei getti, in abs, anticalcare (191D8); flessibile 150 cm.

3-way shower column including: bath/shower mixer with diverter integrated in the spout; 25x25 cm ultra-flat shower head with rounded corners in polished stainless steel (SD00125); height-adjustable telescopic brass column; 4-function hand shower with button for changing the jets, in abs, anti-limescale (191D8); 150 cm flexible hose.

CR

**17AARDX25**

Set doccia composto da: miscelatore a incasso con deviatore (173AR); soffione ultrapiatto 25x25 cm con angoli arrotondati in acciaio INOX lucidato (SD00125); braccio a parete in ottone 30 cm (BD00330); saliscendi cromato con asta ovale; doccetta a 4 funzioni con pulsante per il cambio dei getti, in abs, anticalcare (191D8); presa acqua a muro (752PA); flessibile 150 cm.

Shower set including: built-in mixer with diverter (173AR); 25x25 cm ultra-flat shower head with rounded corners in polished stainless steel (SD00125); 30 cm brass wall arm (BD00330); c.p. sliding rail with oval rod; 4-function hand shower with button for changing the jets, in abs, anti-limescale (191D8); wall connection pipe (752PA); 150 cm flexible hose.

CR

**17BARDX25**

Set doccia composto da: miscelatore a incasso con deviatore (173AR); soffione ultrapiatto 25x25 cm con angoli arrotondati in acciaio INOX lucidato (SD00125); braccio a parete in ottone 30 cm (BD00330); doccetta a 4 funzioni con pulsante per il cambio dei getti, in abs, anticalcare (191D8); presa acqua a muro con supporto fisso (242MN); flessibile 150 cm.

Shower set including: built-in mixer with diverter (173AR); 25x25 cm ultra-flat shower head with rounded corners in polished stainless steel (SD00125); 30 cm brass wall arm (BD00330); 4-function hand shower with button for changing the jets, in abs, anti-limescale (191D8); wall connection pipe with shower holder (242MN); 150 cm flexible hose.

CR

**76DD8**

Kit composto da: saliscendi cromato con asta ovale con doccetta a 4 funzioni con pulsante per il cambio dei getti, in abs, anticalcare (191D8); flessibile 150 cm.

Kit including: c.p. sliding rail with oval rod with 4-function hand shower with button for changing the jets, in abs, anti-limescale (191D8); 150 cm flexible hose.

CR

AVENUE

5th AVENUE

ARMONIA

ULTRAMINIMAL

POLAR

NEXT

RIVER

STILNOVO

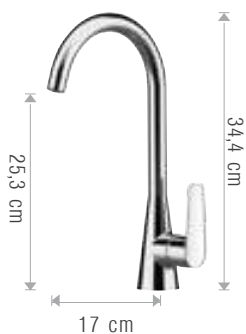

596AR

Miscelatore monocomando lavello con bocca alta a "c" girevole.
Single-lever sink mixer with high movable "c" spout.

CR

FIN (.14 .08)



597AR

Miscelatore monocomando lavello con bocca alta a "u" girevole.
Single-lever sink mixer with high movable "u" spout.

CR



594AR

Miscelatore monocomando per lavello con canna alta girevole e sistema di doccetta monofunzione estraibile.
Single-lever sink mixer with high swivel spout and 1-function pull-out hand shower.

CR

FIN (.14 .08)



595AR

Miscelatore monocomando per lavello con canna alta girevole e doccetta estraibile a due funzioni.
Single-lever sink mixer with high movable spout and 2-functions pull-out hand shower.

CR

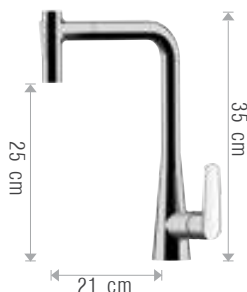

591AR

Miscelatore monocomando per lavello, con canna alta girevole e doccetta estraibile con impugnatura a martello a due funzioni.
Single-lever sink mixer with high swivel spout and 2-functions pull-out "hammer shaped" handle hand shower.

CR



AVENUE

5TH AVENUE

ARMONIA

ULTRAMINIMAL

POLAR

NEXT

RIVER

STILNOVO

594AR





ULTRAMINIMAL





Nata dalla qualità e dall'avanzata tecnologia produttiva di Rubinetterie Mariani, ULTRAMINIMAL è una collezione di miscelatori monocomando dalla linea essenziale, minimalista e moderna.

Il design della rubinetteria unisce all'essenzialità delle linee e alla "ultra minimizzazione" dei volumi una piacevole praticità di utilizzo che rende ULTRAMINIMAL una collezione unica ed esclusiva.

La collezione è dotata di cartuccia a dischi ceramici Ø 25 mm per lavabo e bidet e Ø 35 mm per incassi doccia.

Born from the quality and the advanced production technology of Rubinetterie Mariani, ULTRAMINIMAL is a collection of single-lever mixers with an essential, minimalist and modern line.

The faucets design combines the essentiality of the lines and the "ultra-minimization" of the volumes with a pleasant ease of use that makes ULTRAMINIMAL a unique and exclusive collection.

The collection is equipped with ceramic disc cartridge Ø 25 mm for basins and bidet and Ø 35 mm for shower mixer.



OPZIONI DI FINITURA

La collezione ULTRAMINIMAL è disponibile con 3 diverse opzioni di finitura, oltre al cromato: Nero Opaco (.14), Bianco Opaco (.37), Nichel Spazzolato (.08). Indicare il codice di finitura al momento dell'ordine.



ULTRAMINIMAL

FINISHING OPTIONS

ULTRAMINIMAL collection is available with 3 different finishing options, in addition to chrome: Matt Black (.14), Matt White (.37), Brushed Nickel (.08). Refer to the finishing code when ordering.



Nero Opaco
Matt Black

.14



Bianco Opaco
Matt White

.37



Nichel Spazzolato
Brushed Nickel

.08



393UM

Miscelatore monocomando lavabo con scarico.
Single-lever basin mixer with waste.

CR

FIN (.14 .37 .08)



398UM

Miscelatore monocomando lavabo alto senza scarico.
High basin mixer without waste.

CR

FIN (.14 .37 .08)

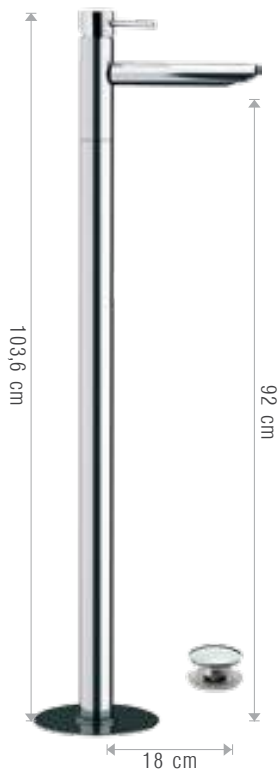

385UM

Miscelatore monocomando lavabo da pavimento con scarico click-clack e troppo pieno.
Single-lever basin mixer floor-mounting with click-clack waste and overflow.

CR

FIN (.14 .37 .08)



380UM

Miscelatore monocomando lavabo senza scarico e senza foro sul corpo.
Single-lever basin mixer without waste and without body hole.

CR

FIN (.14 .37 .08)



305UM

Miscelatore monocomando lavabo a due fori, senza scarico.
Two holes single-lever washbasin mixer, without waste.

CR

FIN (.14 .37 .08)



493UM

Miscelatore monocomando bidet con scarico.
Single-lever bidet mixer with pop-up waste.

CR

FIN (.14 .37 .08)



480UM

Miscelatore monocomando bidet senza scarico, con foro sul corpo.
Single-lever bidet mixer without waste with body hole.

CR

FIN (.14 .37 .08)

15,8 cm

**565UM**

Miscelatore monocomando lavabo ad incasso, completo.
Built-in single-lever basin mixer, complete.

CR

FIN (.14 .37 .08)

15,8 cm

**565UMP**

Miscelatore monocomando a incasso per lavabo su doppia piastra, completo.
Single-lever built-in basin mixer with double flange, complete.

CR

FIN (.14 .37 .08)

565UME

Solo parte esterna
Only external component

CR

FIN (.14 .37 .08)

565AVINC

Solo parte incasso
Only built-in components

CR

FIN (.14 .37 .08)

565UMPE

Solo parte esterna
Only external component

CR

FIN (.14 .37 .08)

565AVINC

Solo parte incasso
Only built-in components

CR

FIN (.14 .37 .08)



565UMP

AVENUE

5TH AVENUE

ARMONIA

ULTRAMINIMAL

POLAR

NEXT

RIVER

STILNOVO



185UMW

Miscelatore incasso per shut-off
comprensivo di doccetta shut-off, supporto
doccia, presa acqua, su piastra in ottone
cromato e flessibile doccia da 120 cm.
Built-in shut-off mixer set including shut-
off handshower, connection pipe on flange,
completely in c.p. brass and shower flexible
120 cm.

CR

FIN (.14 .37 .08)



230UM

Miscelatore monocomando vasca con
accessori.
Bath mixer with accessories.

CR

FIN (.14 .37 .08)

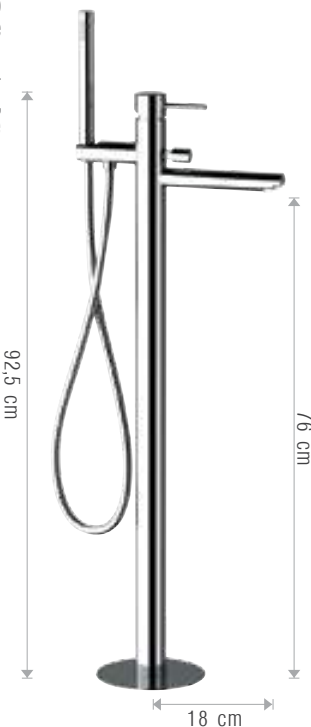

21AUM

Miscelatore monocomando vasca da
pavimento con doccetta in ottone cromato.
Single-lever bath mixer floor-mounting
with chrome plated shower.

CR

FIN (.14 .37 .08)



212UM

Miscelatore monocomando vasca senza
Set doccia.
Wall mtg. single-lever bath mixer without
accessories.

CR

FIN (.14 .37 .08)



252UM

Miscelatore monocomando doccia.
Wall mtg single-lever shower mixer.

CR

FIN (.14 .37 .08)



130UM

Bocca Incasso.
Built-in spout.

CR

FIN

**179UM**

Miscelatore monocomando incasso, completo.
Concealed single-lever shower mixer, complete.

CR

FIN (.14 .37 .08)

**173UM**

Miscelatore monocomando incasso con deviatore, completo.
Concealed single-lever shower mixer with diverter, complete.

CR

FIN (.14 .37 .08)

179UME

Solo parte esterna
Only external component

CR

FIN (.14 .37 .08)

179INC35

Solo parte incasso
Only built-in components

CR

FIN (.14 .37 .08)

173UME

Solo parte esterna
Only external component

CR

FIN (.14 .37 .08)

173INC35

Solo parte incasso
Only built-in components

CR

FIN (.14 .37 .08)

**173UMP2**

Miscelatore monocomando incasso con deviatore a 2 vie, completo.
Concealed single-lever shower mixer with 2 ways diverter, complete.

CR

FIN (.14 .37 .08)

**173UMP3**

Miscelatore monocomando incasso con deviatore a 3 vie, completo.
Concealed single-lever shower mixer with 3 ways diverter, complete.

CR

FIN (.14 .37 .08)

173UMP2E

Solo parte esterna
Only external component

CR

FIN (.14 .37 .08)

173INC2

Solo parte incasso
Only built-in components

CR

FIN (.14 .37 .08)

173UMP2E

Solo parte esterna
Only external component

CR

FIN (.14 .37 .08)

173INC3

Solo parte incasso
Only built-in components

CR

FIN (.14 .37 .08)

**173UMP4**

Miscelatore monocomando per doccia con deviatore a 4 vie su unica piastra.
Single-lever built-in shower mixer with 4 ways diverter on single flange.

CR

FIN (.14 .37 .08)

**173UMP5**

Miscelatore monocomando per doccia con deviatore a 5 vie su unica piastra.
Single-lever built-in shower mixer with 5 ways diverter on single flange.

CR

FIN (.14 .37 .08)



Set doccia composto da: miscelatore a incasso con deviatore (173UM); soffione ultrapiatto, in acciaio INOX lucidato (ST00120); braccio a parete in ottone 30 cm (BD00330); asta saliscendi cromata; doccetta a 1 funzione in ottone cromato (191D6); presa acqua a muro (752N0); flessibile 150 cm.

Shower set including: built-in mixer with diverter (173UM); ultra-flat shower head in polished stainless steel (ST00120); 30 cm brass wall arm (BD00330); c.p. sliding rail; 1-function brass hand shower (191D6); wall connection pipe (752N0); 150 cm flexible hose.

17AUMTX20

con soffione doccia Ø20 cm.
with shower head Ø20 cm.

17AUMTX25

con soffione doccia Ø25 cm.
with shower head Ø25 cm.



Set doccia composto da: miscelatore a incasso con deviatore (173UM); soffione ultrapiatto, in acciaio INOX lucidato (ST00120); braccio a parete in ottone 30 cm (BD00330); doccetta a 1 funzione in ottone cromato (191D6); presa acqua a muro con supporto fisso (242MN); flessibile 150 cm.

Shower set including: built-in mixer with diverter (173UM); ultra-flat shower head in polished stainless steel (ST00120); 30 cm brass wall arm (BD00330); 1-function brass hand shower (191D6); wall connection pipe with shower holder (242MN); 150 cm flexible hose.

17BUMTX20

con soffione doccia Ø20 cm.
with shower head Ø20 cm.

17BUMTX25

con soffione doccia Ø25 cm.
with shower head Ø25 cm.



Set doccia composto da: miscelatore con deviatore a 2 vie su piastre separate (176UMPP2); soffione ultrapiatto, in acciaio INOX lucidato (ST00120); braccio a parete in ottone 30 cm (BD00330); doccetta a 1 funzione in ottone cromato (191D6); presa acqua a muro con supporto (242MNB); flessibile 150 cm.

Shower set including: shower mixer with 2-way diverter on separate plates (176UMPP2); ultra-flat shower head in polished stainless steel (ST00120); 30 cm brass wall arm (BD00330); 1-function brass hand shower (191D6); wall connection pipe with shower holder (242MNB); 150 cm flexible hose.

17CUMTX20

con soffione doccia Ø20 cm.
with shower head Ø20 cm.

17CUMTX25

con soffione doccia Ø25 cm.
with shower head Ø25 cm.



176UMPP2

Miscelatore e deviatore su piastre separate.
Built-in shower mixer with diverter on double flange.

CR

FIN (.14 .37 .08)



AVENUE

5TH AVENUE

ARMONIA

ULTRAMINIMAL

POLAR

NEXT

RIVER

STILNOVO

17CUMTX20





AVENUE

5TH AVENUE

ARMONIA

ULTRAMINIMAL

POLAR

NEXT

RIVER

STILNOVO

POLAR





La collezione di rubinetti miscelatori POLAR presenta una geometria essenziale, adatta a tutti gli ambienti arredati con gusto moderno e minimale.

Le linee pulite e squadrate esaltano la semplicità delle forme e l'eleganza delle proporzioni in un forte equilibrio fra praticità e design. La totale assenza di fissaggi a vista rendono POLAR un piccolo gioiello di tecnologia costruttiva.

La collezione è dotata di cartuccia a dischi ceramici Ø 25 mm per lavabo e bidet e Ø 35 mm per incassi doccia.

POLAR mixer faucet collection has an essential geometry, suitable for all those interiors designed with a modern and minimal taste.

The clean and squared lines enhance the simplicity of its shapes and the elegance of each proportion, in a strong balance between comfort and design. The total absence of visible fixings makes POLAR a small jewel of construction technology.

The collection is equipped with ceramic disc cartridge, Ø 25 mm for basin and bidet and Ø 35 mm for shower mixer.

OPZIONI DI FINITURA

La collezione POLAR è disponibile con 3 diverse opzioni di finitura, oltre al cromato: Nero Opaco (.14), Bianco Opaco (.37), Nichel Spazzolato (.08). Indicare il codice di finitura al momento dell'ordine.



POLAR

FINISHING OPTIONS

POLAR collection is available with 3 different finishing options, in addition to chrome: Matt Black (.14), Matt White (.37), Brushed Nickel (.08). Refer to the finishing code when ordering.



Nero Opaco
Matt Black

.14



Bianco Opaco
Matt White

.37



Nichel Spazzolato
Brushed Nickel

.08

AVENUE

5TH AVENUE

ARMONIA

ULTRAMINIMAL

POLAR

NEXT

RIVER

STILNOVO

**393PA**

Miscelatore monocomando lavabo con scarico.
Single-lever basin mixer with pop-up waste

CR

FIN (.14 .37 .08)

**39APA**

Miscelatore monocomando lavabo medio con scarico.
Medium single-lever basin mixer with pop-up waste

CR

FIN (.14 .37 .08)

**382PA**

Miscelatore monocomando lavabo con scarico click-clack, senza foro.
Single-lever basin mixer with click-clack waste, without body hole.

CR

FIN (.14 .37 .08)

**39CPA**

Miscelatore monocomando lavabo medio con scarico click-clack, senza foro.
Medium single-lever basin mixer with click-clack waste, without body hole.

CR

FIN (.14 .37 .08)

**380PA**

Miscelatore monocomando lavabo senza scarico senza foro.
Single-lever basin mixer without waste and without body hole.

CR

FIN (.14 .37 .08)

**39BPA**

Miscelatore monocomando lavabo medio senza scarico senza foro.
Single-lever basin mixer without waste and without body hole.

CR

FIN (.14 .37 .08)

**398PA**

Miscelatore monocomando lavabo alto XL, senza scarico.
Single-lever basin mixer high neck XL, without pop-up waste.

CR

FIN (.14 .37 .08)

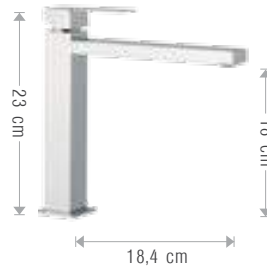
**397PA**

Miscelatore monocomando lavabo alto, senza scarico.
Single-lever basin mixer high neck, without pop-up waste.

CR

FIN (.14 .37 .08)

**399PA**

Miscelatore monocomando lavabo alto XXL, senza scarico.
Single-lever basin mixer high neck XXL, without pop-up waste.

CR

FIN (.14 .37 .08)

**396PA**

Miscelatore monocomando lavabo con canna ad "U" girevole.
Single-lever basin mixer with "U" movable spout.

CR

FIN (.14 .37 .08)

**305PA**

Miscelatore monocomando lavabo due fori, senza scarico.
Two holes single-lever washbasin mixer, without waste.

CR

FIN (.14 .37 .08)

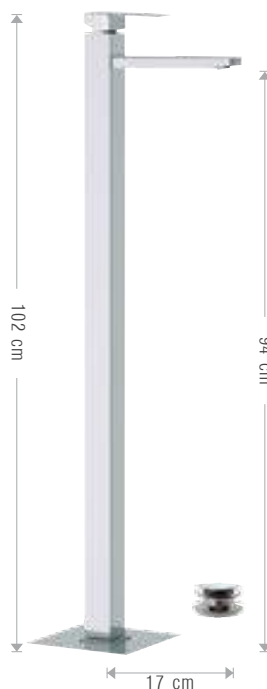
**385PA**

Miscelatore monocomando lavabo da terra con scarico click-clack e troppo pieno.
Single-lever basin mixer floor-mounting with click-clack waste and overflow.

CR

FIN (.14 .37 .08)

**493PA**

Miscelatore bidet con scarico e tettuccio estetico brevettato.
Bidet mixer with pop-up waste and patented aesthetic nozzle cover.

CR

FIN (.14 .37 .08)

**480PA**

Miscelatore bidet senza scarico.
Bidet mixer without pop-up waste.

CR

FIN (.14 .37 .08)

**230PA**

Miscelatore monocomando vasca con accessori e doccetta completamente cromata in ABS.
Bath mixer with accessories and ABS shower completely chromed.

CR

FIN (.14 .37 .08)

**212PA**

Miscelatore monocomando vasca senza Set doccia.
Wall mtg. single-lever bath mixer without accessories.

CR

FIN (.14 .37 .08)

**14APA**

Miscelatore incasso comprensivo di doccetta shut-off, supporto doccia con presa acqua su piastra in ottone cromato e flessibile doccia cm 120.
Built-in shower mixer set including shut-off handshower, shower holder connecting pipe on flange completely in c.p. brass and shower flexible cm 120.

CR

AVENUE

5th AVENUE

ARMONIA

ULTRAMINIMAL

POLAR

NEXT

RIVER

STILNOVO

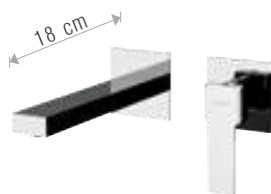
**565PAP**

Miscelatore monocomando lavabo ad incasso a due piastre, completo.
Concealed single-lever basin mixer with two flange, complete.

CR

FIN (.14 .37 .08)

**565PA**

Miscelatore monocomando lavabo ad incasso, con piastra orizzontale, completo.
Concealed single-lever basin mixer, with horizontal wall-flange, complete.

CR

FIN (.14 .37 .08)

565PAPE

Solo parte esterna
Only external component

CR

FIN (.14 .37 .08)

565PAINC

Solo parte incasso
Only built-in components

CR

FIN (.14 .37 .08)

565PAE

Solo parte esterna
Only external component

CR

FIN (.14 .37 .08)

565PAINC

Solo parte incasso
Only built-in components

CR

FIN (.14 .37 .08)

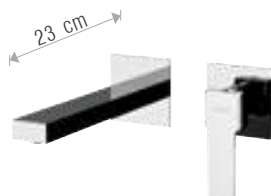
**565PAPL**

Miscelatore monocomando lavabo ad incasso a due piastre, completo.
Concealed single-lever basin mixer with two flange, complete.

CR

FIN (.14 .37 .08)

**565PAL**

Miscelatore monocomando lavabo ad incasso, con piastra orizzontale, completo.
Concealed single-lever basin mixer, with horizontal wall-flange, complete.

CR

FIN (.14 .37 .08)

565PAPEL

Solo parte esterna
Only external component

CR

FIN (.14 .37 .08)

565PAINC

Solo parte incasso
Only built-in components

CR

FIN (.14 .37 .08)

565PALE

Solo parte esterna
Only external component

CR

FIN (.14 .37 .08)

565PAINC

Solo parte incasso
Only built-in components

CR

FIN (.14 .37 .08)

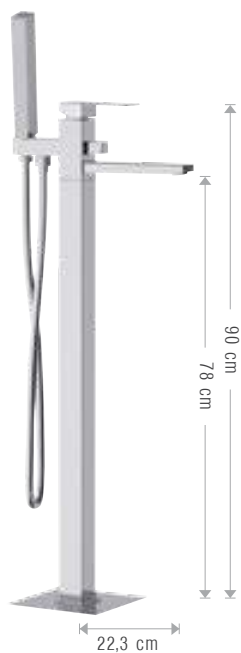
**21APA**

Miscelatore monocomando vasca da pavimento con doccetta in ottone cromato.
Single-lever bath mixer floor-mounting with chrome plated brass shower.

CR

FIN (.14 .37 .08)

**175PA**

Miscelatore monocomando per vasca da incasso su piastra rettangolare. Lunghezza bocca: 18 cm. Doccetta in ABS completamente cromata.

Built-in single-lever bath mixer with rectangular wall-flange. Length spout 18 cm. ABS shower completely chromed.

CR

AVENUE

5TH AVENUE

ARMONIA

ULTRAMINIMAL

POLAR

NEXT

RIVER

STILNOVO



565PA

**236PA**

Batteria bordo vasca 4 fori con deviatore, bocca con effetto fontana e doccetta in ottone cromato.

4 holes deck mounted bath/shower mixer with diverter, spout with fountain effect and c.p. brass handshower.

CR

**237PA**

Batteria bordo vasca 3 fori. Doccetta in ottone cromato.

3 holes bath shower mixer, handshower in c.p. brass.

CR

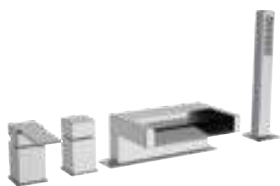
**239PA**

Batteria bordo vasca 4 fori con deviatore, bocca a cascata e doccetta in ottone cromato.

4 holes deck mounted bath/shower mixer with diverter, waterfall spout and c.p. brass handshower.

CR

**252PA**

Miscelatore doccia esterno.

Wall mtg. shower mixer, without accessories.

CR

FIN (.14 .37 .08)

**259PA**

Miscelatore monocomando doccia senza accessori con attacco superiore da 3/4".

Wall mtg. single-lever shower mixer without accessories with 3/4" connection.

CR

FIN (.14 .37 .08)

**6Q001**

Soffione a muro per Set doccia multigetti 4,2x4,2 cm in ottone, orientabile ed ispezionabile.

Orientable and inspectable side shower head for shower multijet kit 4,2x4,2 cm in brass.

CR

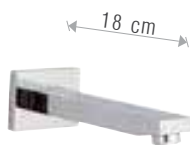
**130PA**

Bocca incasso.
Built-in spout.

CR

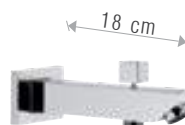
**132QD**

Bocca incasso con deviatore, lunghezza bocca 17 cm.

Built-in spout with diverter, length spout 17 cm.

CR

**179PA**

Miscelatore monocomando incasso, completo.
Concealed single-lever shower mixer, complete.

CR

FIN (.14 .37 .08)

**173PA**

Miscelatore monocomando incasso con deviatore, completo.
Concealed single-lever shower mixer with diverter, complete.

CR

FIN (.14 .37 .08)

179PAE

Solo parte esterna
Only external component

CR

FIN (.14 .37 .08)

179INC35

Solo parte incasso
Only built-in components

CR

FIN (.14 .37 .08)

173PAE

Solo parte esterna
Only external component

CR

FIN (.14 .37 .08)

173INC35

Solo parte incasso
Only built-in components

CR

FIN (.14 .37 .08)

**173PAP2**

Miscelatore monocomando per doccia con deviatore a 2 vie su unica piastra, completo.
Single-lever built-in shower mixer with 2 ways diverter on single flange, complete.

CR

FIN (.14 .37 .08)

**173PAP3**

Miscelatore monocomando per doccia con deviatore a 3 vie su unica piastra, completo.
Single-lever built-in shower mixer with 3 ways diverter on single flange, complete.

CR

FIN (.14 .37 .08)

173PAP2E

Solo parte esterna
Only external component

CR

FIN (.14 .37 .08)

173INCP2

Solo parte incasso
Only built-in components

CR

FIN (.14 .37 .08)

173PAP2E

Solo parte esterna
Only external component

CR

FIN (.14 .37 .08)

173INCP3

Solo parte incasso
Only built-in components

CR

FIN (.14 .37 .08)

**173PAP4**

Miscelatore monocomando per doccia con deviatore a 4 vie su unica piastra.
Single-lever built-in shower mixer with 4 ways diverter on single flange.

CR

FIN (.14 .37 .08)

**173PAPP4**

Miscelatore monocomando per doccia con deviatore a 4 vie su due piastre.
Single-lever built-in shower mixer with 4 ways diverter on double flange.

CR

FIN (.14 .37 .08)

173PAP5

Miscelatore monocomando per doccia con deviatore a 5 vie su unica piastra.
Single-lever built-in shower mixer with 5 ways diverter on single flange.

CR

FIN (.14 .37 .08)

173PAPP5

Miscelatore monocomando per doccia con deviatore a 5 vie su due piastre.
Single-lever built-in shower mixer with 5 ways diverter on double flange.

CR

FIN (.14 .37 .08)

**17BPASR002**

Set doccia composto da: miscelatore a incasso con deviatore (173PA); soffione a parete 50x20 cm con getto a pioggia, in acciaio INOX lucidato (SR002); doccetta rettangolare piatta a 1 funzione, in ottone (191D9); presa acqua a muro con supporto snodato (242QD); flessibile 150 cm.

Shower set including: built-in mixer with diverter (173PA); 50x20 cm wall shower head with rain jet, in polished stainless steel (SR002); 1-function flat rectangular hand shower, in brass (191D9); w a l l connection pipe with adjustable shower holder (242QD); 150 cm flexible hose.

CR

**170PA**

Set doccia composto da: miscelatore a incasso con deviatore a 4 vie su unica piastra (173PAP4); soffione a parete 50x20 cm con 2 uscite: pioggia e cascata, in acciaio INOX lucidato (SR003); doccetta a 1 funzione in abs cromato (191QD); presa acqua a muro con supporto snodato (242QD); 6 getti a muro in ottone orientabili (GQ001); flessibile 150 cm.

Shower set including: built-in mixer with 5-way diverter on double plate (173PAPP5); 25x25 cm shower head in c.p. ABS (SQA0125); 30 cm brass shower arm, squared shape (BD00430); adjustable shower holder in c.p. ABS for conical hose; 1-function hand shower in c.p. abs (191QD); wall connection pipe (752PA); 6 adjustable brass wall jets (GQ001); 150 cm flexible hose.

CR



Set doccia composto da: miscelatore a incasso con deviatore (173PA); soffione ultrapiatto 20x20 cm in acciaio INOX lucidato (SQ00420); braccio piatto a parete in ottone 30 cm (BD00930); doccetta rettangolare piatta a 1 funzione, in ottone (191D9); presa acqua a muro con supporto snodato (242QD); flessibile 150 cm.

Shower set including: built-in mixer with diverter (173PA); 20x20 cm ultra-flat shower head in polished stainless steel (SQ00420); 30 cm flat brass wall arm (BD00930); 1-function flat rectangular hand shower, in brass (191D9); w a l l connection pipe with adjustable shower holder (242QD); 150 cm flexible hose.



Set doccia composto da: miscelatore a incasso con deviatore (173PA); soffione 20x20 cm in ottone cromato (SQB0120); braccio a parete 30 cm in ottone, forma squadrata (BD00430); doccetta a 1 funzione in abs cromato (191QD); presa acqua a muro con supporto snodato (242QD); flessibile 150 cm.

Shower set including: built-in mixer with diverter (173PA); 20x20 cm shower head in c.p. brass (SQB0120); 30 cm brass shower arm, squared shape (BD00430); 1-function hand shower in c.p. abs (191QD); wall connection pipe with adjustable shower holder (242QD); 150 cm flexible hose.

17BPAQX20

con soffione doccia 20x20 cm, con braccio doccia 30 cm.
with shower head 20x20 cm with arm 30 cm.

17BPAQX25

con soffione doccia 25x25 cm, con braccio doccia 30 cm.
with shower head 25x25 cm with arm 30 cm.

17BPAQX30

con soffione doccia 30x30 cm, con braccio doccia 30 cm.
with shower head 30x30 cm with arm 30 cm.

17BPA

con braccio doccia a parete 30 cm.
with wall arm 30 cm.

17BPAY

con braccio doccia a soffitto 30 cm.
with ceiling arm 30 cm

**17BPAP2QX25**

Set doccia composto da: miscelatore a incasso con deviatore a 2 vie su unica piastra (173PAP2); soffione ultrapiatto 25x25 cm in acciaio INOX lucidato (SQ00425); braccio a parete 30 cm in ottone, forma squadrata (BD00430); doccetta a 1 funzione in abs cromato (191QD); presa acqua a muro con supporto snodato (242QD); flessibile 150 cm.

Shower set including: built-in mixer with 2-way diverter on a single plate (173PAP2); 25x25 cm ultra-flat shower head in polished stainless steel (SQ00425); 30 cm brass shower arm, squared shape (BD00430); 1-function hand shower in c.p. abs (191QD); wall connection pipe with adjustable shower holder (242QD); 150 cm flexible hose.

CR



Set doccia composto da: miscelatore a incasso con deviatore (173PA); soffione ultrapiatto 20x20 cm in acciaio INOX lucidato (SQ00420); braccio a soffitto in ottone 30 cm, squadrato (BD00830); doccetta rettangolare piatta a 1 funzione, in ottone (191D9); presa acqua a muro con supporto snodato (242QD); flessibile 150 cm.

Shower set including: built-in mixer with diverter (173PA); 20x20 cm ultra-flat shower head in polished stainless steel (SQ00420); 30 cm brass ceiling arm, squared shape (BD00830); 1-function flat rectangular hand shower, in brass (191D9); wall connection pipe with adjustable shower holder (242QD); 150 cm flexible hose.

17BPAYQX20

con soffione doccia 20x20 cm, con braccio a soffitto 30 cm.
with shower head 20x20 cm with ceiling arm 30 cm;

17BPAYQX25

con soffione doccia 25x25 cm, con braccio a soffitto 30 cm.
with shower head 25x25 cm with ceiling arm 30 cm;

17BPAYQX30

con soffione doccia 30x30 cm, con braccio a soffitto 30 cm.
with shower head 30x30 cm with ceiling arm 30 cm;



Set doccia composto da: miscelatore a incasso con deviatore (173PA); soffione ultrapiatto 20x20 cm in acciaio INOX lucidato (SQ00420); braccio a soffitto in ottone 30 cm, squadrato (BD00830); saliscendi piatto in ottone; doccetta rettangolare piatta a 1 funzione, in ottone (191D9); presa acqua a muro (752PA); flessibile 150 cm.

Shower set including: built-in mixer with diverter (173PA); 20x20 cm ultra-flat shower head in polished stainless steel (SQ00420); 30 cm brass ceiling arm, squared shape (BD00830); ultra-flat brass sliding rail; 1-function flat rectangular hand shower, in brass (191D9); wall connection pipe (752PA); 150 cm flexible hose.

17APAYQX20

con soffione doccia 20x20 cm, con braccio a soffitto 30 cm.
with shower head 20x20 cm with ceiling arm 30 cm;

17APAYQX25

con soffione doccia 25x25 cm, con braccio a soffitto 30 cm.
with shower head 25x25 cm with ceiling arm 30 cm;

17APAYQX30

con soffione doccia 30x30 cm, con braccio a soffitto 30 cm.
with shower head 30x30 cm with ceiling arm 30 cm;

CUCINA - KITCHEN

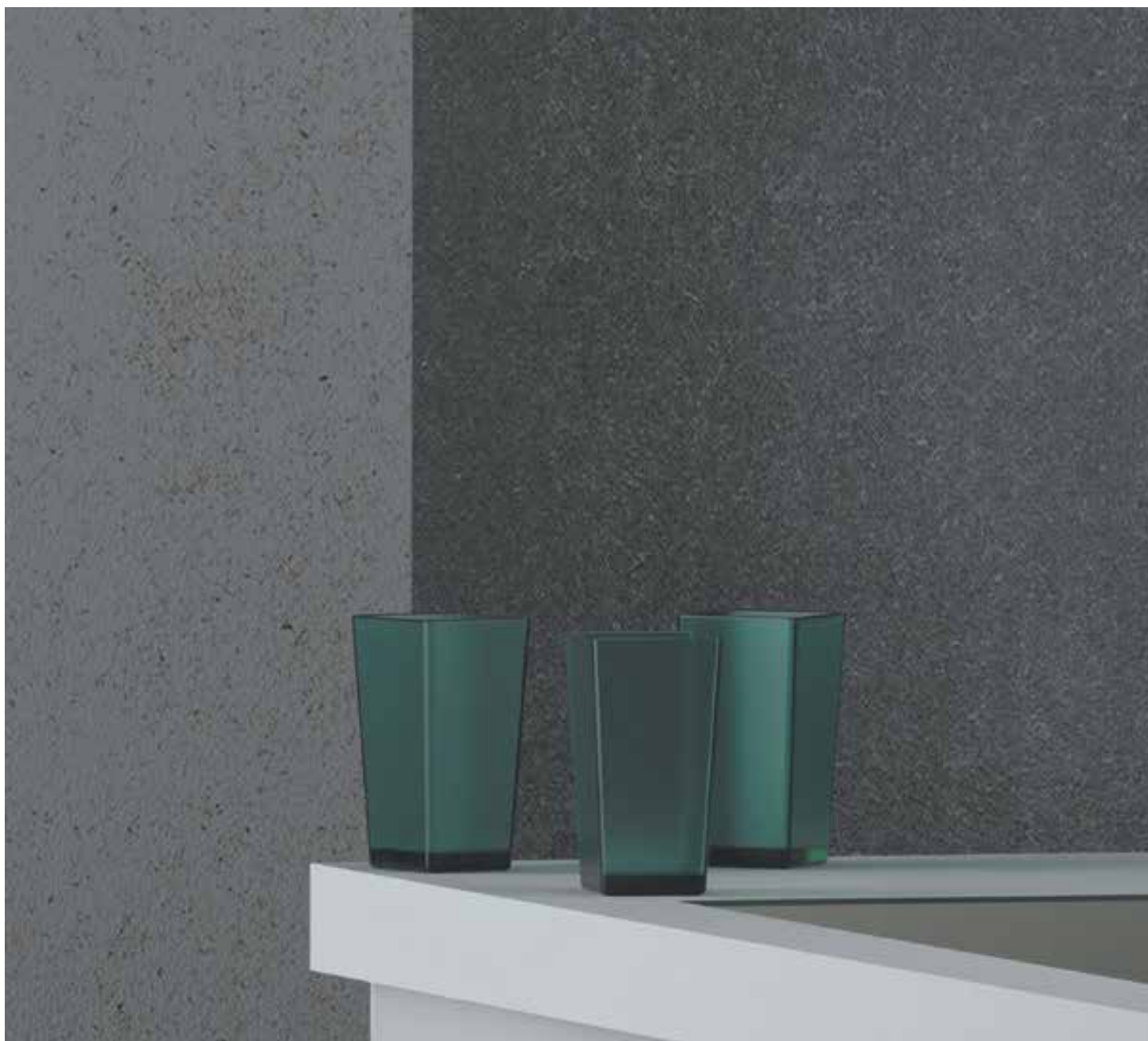

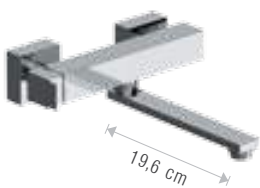

570PA

**501PA**

Miscelatore monocomando lavello a muro.
Cartuccia Ø 25 mm.
Wall mtg. single-lever sink mixer. Ø 25
cartridge.

CR

FIN (.14 .37 .08)

**570PA**

Miscelatore monocomando lavello.
Single-lever sink mixer.

CR

FIN (.14 .37 .08)





AVENUE

5TH AVENUE

ARMONIA

ULTRAMINIMAL

POLAR

NEXT

RIVER

STILNOVO

NEXT



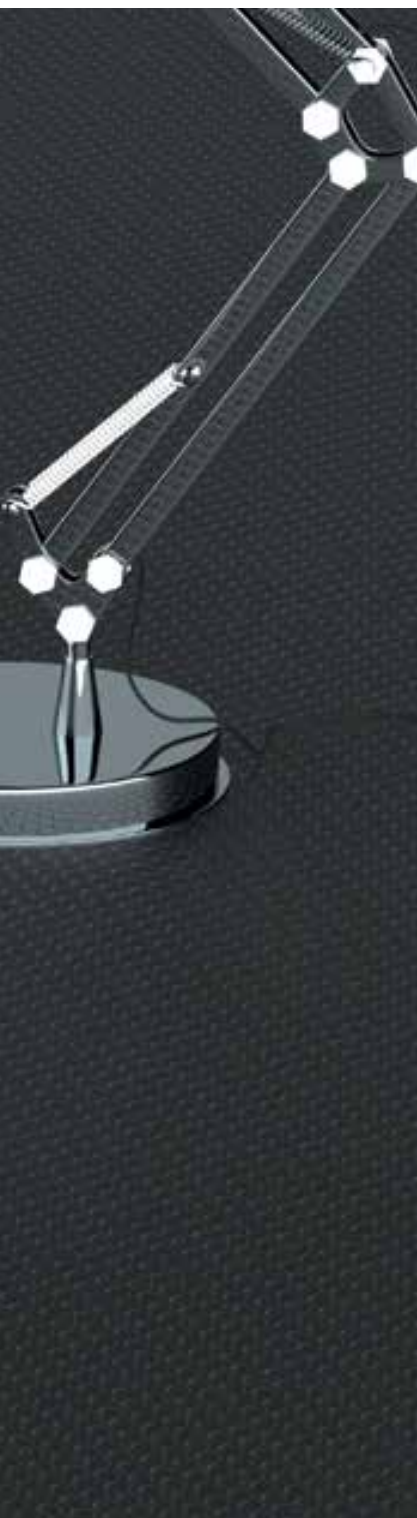

Semplice, elegante e dalle forme delicate, la collezione di rubinetteria monocomando NEXT è una scelta sicura per completare con stile ogni tipologia di arredo, dal più classico al più moderno.

La rotondità del corpo viene alleggerita da una leva di miscelazione geometrica e minimale, mentre la curvatura finale della bocca accentua la dolcezza del design e accompagna l'acqua nel suo fluire.

La collezione è dotata di cartuccia a dischi ceramici Ø 35.

Simple, elegant and with delicate shapes, the single-lever faucet collection "NEXT" is a safe choice to complete with style all bathroom interiors, from the most classic to the most modern one.

The roundness of the body is lightened by a geometric and minimalistic mixing lever, while the final bending of the mixer mouth accentuates the mildness of the design and accompanies the water in its flow.

The collection is equipped with a Ø 35 mm ceramic disc cartridge.



NEXT

OPZIONI DI FINITURA

La collezione NEXT è disponibile con 1 opzione di finitura alternativa al cromato: Nero Opaco (.14).
Indicare il codice di finitura al momento dell'ordine.



NEXT

FINISHING OPTIONS

NEXT collection is available with 1 finishing option, alternative to chrome: Matt Black (.14).
Refer to the finishing code when ordering.

AVENUE

5TH AVENUE

ARMONIA

ULTRAMINIMAL

POLAR

NEXT

RIVER

STILNOVO



Nero Opaco
Matt Black

.14

SLIM NEXT

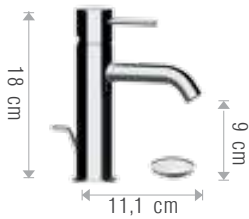

393NS

Miscelatore monocomando lavabo con scarico, diametro corpo 40 mm.
Single-lever basin mixer with waste, body diameter 40 mm.

CR

FIN (.14)

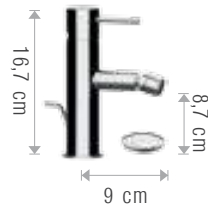

493NS

Miscelatore monocomando bidet con scarico, diametro corpo 40 mm.
Single-lever bidet mixer with pop-up waste, body diameter 40 mm.

CR

FIN (.14)

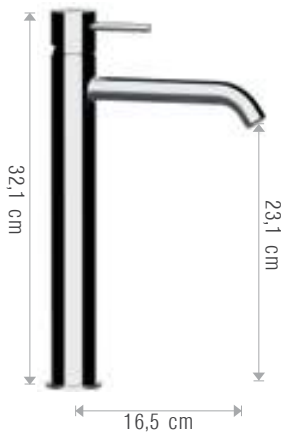

398NS

Miscelatore monocomando lavabo alto senza scarico, diametro corpo 40 mm.
High basin mixer without waste, body diameter 40 mm.

CR

FIN (.14)

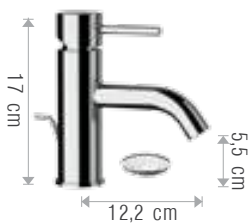

393NX

Miscelatore monocomando lavabo con scarico, diametro corpo 45 mm.
Single-lever basin mixer with waste, body diameter 45 mm.

CR

FIN (.14)

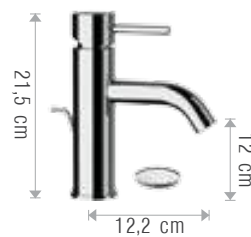

39ANX

Miscelatore monocomando lavabo modello L con scarico, diametro corpo 45 mm.
Single-lever basin mixer, L size, with waste, body diameter 45 mm.

CR

FIN (.14)

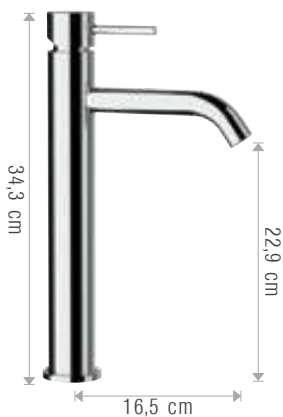

398NX

Miscelatore monocomando lavabo alto, modello XL, senza scarico, diametro corpo 45 mm.
High basin mixer, XL size, without waste, body diameter 45 mm.

CR

FIN (.14)

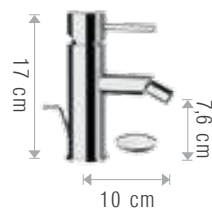

493NX

Miscelatore monocomando bidet con scarico, diametro corpo 45 mm.
Single-lever bidet mixer with pop-up waste, body diameter 45 mm.

CR

FIN (.14)

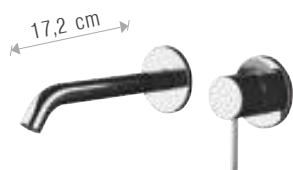
**565NXP**

Miscelatore monocomando a incasso per lavabo su doppia piastra, completo.
Single-lever built-in basin mixer with double flange, complete.

CR

FIN (.14)

**565NX**

Miscelatore monocomando lavabo ad incasso, completo.
Built-in single-lever basin mixer, complete.

CR

FIN (.14)

565NXPE

Solo parte esterna
Only external component

CR

FIN (.14)

565ARINC

Solo parte incasso
Only built-in components

CR

FIN (.14)

565NXE

Solo parte esterna
Only external component

CR

FIN (.14)

565ATINC

Solo parte incasso
Only built-in components

CR

FIN (.14)



565NXP

AVENUE

5TH AVENUE

ARMONIA

ULTRAMINIMAL

POLAR

NEXT

RIVER

STILNOVO

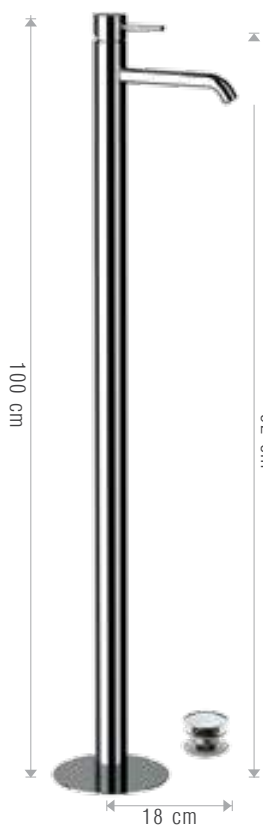

385NX

Miscelatore monocomando lavabo da pavimento con scarico click-clack e troppo pieno.
Single-lever basin mixer floor-mounting with click-clack waste and overflow.

CR

FIN (.14)

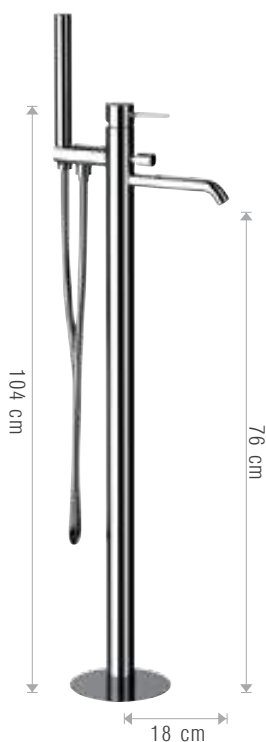

21ANX

Miscelatore monocomando vasca da pavimento con doccetta in ottone cromato.
Single-lever bath mixer floor-mounting with chrome plated shower.

CR

FIN (.14)





AVENUE

5TH AVENUE

ARMONIA

ULTRAMINIMAL

POLAR

NEXT

RIVER

STILNOVO

21ANX



14ANX

Miscelatore incasso comprensivo di doccetta shut-off, supporto doccia, presa acqua su piastra in ottone cromato e flessibile doccia 120 cm.

Built-in shower mixer set including shut-off handshower, shower holder, connection pipe on flange completely in c.p. brass and shower flexible 120 cm.

CR

FIN (.14)



185NXW

Miscelatore incasso per shut-off comprensivo di doccetta shut-off, supporto doccia, presa acqua, su piastra in ottone cromato e flessibile doccia da 120 cm.

Built-in shower mixer set including shut-off handshower, connection pipe on flange, completely in c.p. brass and shower flexible 120 cm.

CR

FIN (.14)



230NX

Miscelatore monocomando vasca con accessori.

Bath mixer with accessories.

CR

FIN (.14)



212NX

Miscelatore monocomando vasca senza Set doccia.

Wall mtg. single-lever bath mixer without accessories.

CR

FIN (.14)



305NX

Miscelatore monocomando lavabo a due fori, senza scarico.

Two holes single-lever washbasin mixer, without waste.

CR

FIN (.14)

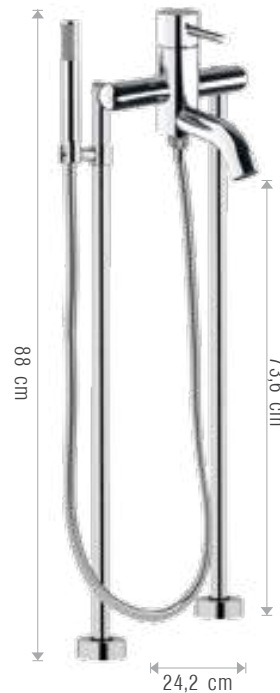

21BNX

Miscelatore monocomando vasca con doccetta, su colonne da pavimento.

Single-lever bath mixer with handshower, on floor columns.

CR

FIN (.14)

**237NX**

Batteria bordo vasca 3 fori.
3 holes bath shower mixer.

CR

**252NX**

Miscelatore monocomando doccia.
Wall mtg single-lever shower mixer.

CR

FIN (.14)

**259NX**

Miscelatore monocomando doccia con
attacco alto da 3/4".
Wall mtg single-lever shower mixer, with
3/4" upper connection.

CR

FIN (.14)

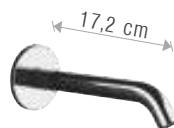
**130NX**

Bocca incasso.
Built-in spout.

CR

FIN (.14)

**179NS**

Miscelatore monocomando incasso.
Concealed single-lever shower mixer.

CR

FIN (.14)

**173NS**

Miscelatore monocomando incasso con
deviatore.
Concealed single-lever shower mixer with
diverter.

CR

FIN (.14)

179NSE

Solo parte esterna
Only external component

CR

FIN (.14)

179INC35

Solo parte incasso
Only built-in components

CR

FIN (.14)

173NSE

Solo parte esterna
Only external component

CR

FIN (.14)

173INC35

Solo parte incasso
Only built-in components

CR

FIN (.14)



179NX

Miscelatore monocomando incasso, completo.
Concealed single-lever shower mixer, complete.

CR

FIN (.14)



173NX

Miscelatore monocomando incasso con deviatore, completo.
Concealed single-lever shower mixer with diverter, complete.

CR

FIN (.14)

179NXE

Solo parte esterna
Only external component

CR

FIN (.14)

179INC35

Solo parte incasso
Only built-in components

CR

FIN (.14)

173NXE

Solo parte esterna
Only external component

CR

FIN (.14)

173INC35

Solo parte incasso
Only built-in components

CR

FIN (.14)



173NXP2

Miscelatore monocomando incasso con deviatore a 2 vie, completo.
Concealed single-lever shower mixer with 2 ways diverter, complete.

CR

FIN (.14)



173NXP3

Miscelatore monocomando incasso con deviatore a 3 vie, completo.
Concealed single-lever shower mixer with 3 ways diverter, complete.

CR

FIN (.14)

173NXP2E

Solo parte esterna
Only external component

CR

FIN (.14)

173INC2

Solo parte incasso
Only built-in components

CR

FIN (.14)

173NXP2E

Solo parte esterna
Only external component

CR

FIN (.14)

173INC3

Solo parte incasso
Only built-in components

CR

FIN (.14)

**179NXQ**

Miscelatore monocomando incasso, completo.
Concealed single-lever shower mixer, complete.

CR

FIN (.14)

**173NXQ**

Miscelatore monocomando incasso con deviatore, completo.
Concealed single-lever shower mixer with diverter, complete.

CR

FIN (.14)

179NXQE

Solo parte esterna
Only external component

CR

FIN (.14)

179INC35

Solo parte incasso
Only built-in components

CR

FIN (.14)

173NXQE

Solo parte esterna
Only external component

CR

FIN (.14)

173INC35

Solo parte incasso
Only built-in components

CR

FIN (.14)

**173NXQP2**

Miscelatore monocomando incasso con deviatore a 2 vie, completo.
Concealed single-lever shower mixer with 2 ways diverter, complete.

CR

FIN (.14)

**173NXQP3**

Miscelatore monocomando incasso con deviatore a 3 vie, completo.
Concealed single-lever shower mixer with 3 ways diverter, complete.

CR

FIN (.14)

173NXQP2E

Solo parte esterna
Only external component

CR

FIN (.14)

173INCP2

Solo parte incasso
Only built-in components

CR

FIN (.14)

173NXQP2E

Solo parte esterna
Only external component

CR

FIN (.14)

173INCP3

Solo parte incasso
Only built-in components

CR

FIN (.14)



Set doccia composto da: miscelatore a incasso con deviatore (173NX); soffione ultrapiatto, in acciaio INOX lucidato (ST00120); braccio a parete in ottone 30 cm (BD00330); doccetta a 1 funzione in ottone cromato (191D6); presa acqua a muro con supporto fisso (242MN); flessibile 150 cm.

Shower set including: built-in mixer with diverter (173NX); ultra-flat shower head in polished stainless steel (ST00120); 30 cm brass wall arm (BD00330); 1-function brass hand shower (191D6); wall connection pipe with shower holder (242MN); 150 cm flexible hose.



17BNXTX20

con soffione doccia Ø20 cm.
with shower head Ø20 cm.

17BNXTX25

con soffione doccia Ø25 cm.
with shower head Ø25 cm.



Set doccia composto da: miscelatore a incasso con deviatore (173NX); soffione ultrapiatto, in acciaio INOX lucidato (ST00120); braccio a parete in ottone 30 cm (BD00330); asta saliscendi cromata; doccetta a 1 funzione in ottone cromato (191D6); presa acqua a muro (752N0); flessibile 150 cm.

Shower set including: built-in mixer with diverter (173NX); ultra-flat shower head in polished stainless steel (ST00120); 30 cm brass wall arm (BD00330); c.p. sliding rail; 1-function brass hand shower (191D6); wall connection pipe (752N0); 150 cm flexible hose.



17ANXTX20

con soffione doccia Ø20 cm.
with shower head Ø20 cm.

17ANXTX25

con soffione doccia Ø25 cm.
with shower head Ø25 cm.



17ANS

Set doccia composto da: miscelatore a incasso con deviatore (173NF); soffione Ø 20 cm in abs cromato; braccio a parete in ottone 30 cm (BD00330); asta saliscendi cromata; doccetta a 1 funzione in ottone cromato (191D6); presa acqua a muro (752N0); flessibile 150 cm.

Shower set including: built-in mixer with diverter (173NF); Ø 20 cm shower head in c.p. abs; 30 cm brass wall arm (BD00330); c.p. sliding rail; 1-function brass hand shower (191D6); wall connection pipe (752N0); 150 cm flexible hose.



CR



17FNX

Set vasca composto da: miscelatore a incasso con deviatore a 2 vie su piastre separate; doccetta a 1 funzione in ottone cromato (191D6); presa acqua a muro con supporto (242MNB); bocca a incasso (130NXB); flessibile 150 cm.

Bathtub set including: built-in mixer with 2-way diverter on double plate; 1-function brass hand shower (191D6); wall connection pipe with shower holder (242MNB); built-in spout (130NXB); 150 cm flexible hose.

CR



Set doccia composto da: miscelatore a incasso con deviatore a 2 vie su piastre separate; soffione ultrapiatto, in acciaio INOX lucidato (ST00120); braccio a parete in ottone 30 cm (BD00330); doccetta a 1 funzione in ottone cromato (191D6); presa acqua a muro con supporto (242MNB); flessibile 150 cm.

Shower set including: built-in mixer with 2-way diverter on double plate; ultra-flat shower head in polished stainless steel (ST00120); 30 cm brass wall arm (BD00330); 1-function brass hand shower (191D6); wall connection pipe with shower holder (242MNB); 150 cm flexible hose.



17CNXTX20

con soffione doccia Ø20 cm.
with shower head Ø20 cm.

17CNXTX25

con soffione doccia Ø25 cm.
with shower head Ø25 cm.



17BNS

Set doccia composto da: miscelatore a incasso con deviatore (173NF); soffione Ø 20 cm in abs cromato; braccio a parete in ottone 30 cm (BD00330); doccetta a 1 funzione in ottone cromato (191D6); presa acqua a muro con supporto fisso (242MN); flessibile 150 cm.

Shower set including: built-in mixer with diverter (173NF); Ø 20 cm shower head in c.p. abs; 30 cm brass wall arm (BD00330); 1-function brass hand shower (191D6); wall connection pipe with shower holder (242MN); 150 cm flexible hose.



CR



AVENUE

5TH AVENUE

ARMONIA

ULTRAMINIMAL

POLAR

NEXT

RIVER

STILNOVO

17BNXTX20

CUCINA - KITCHEN

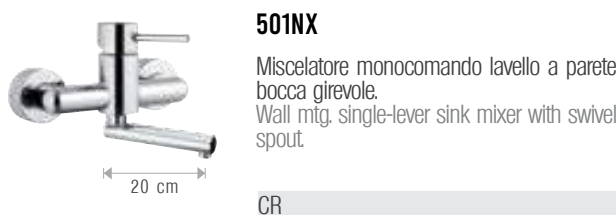
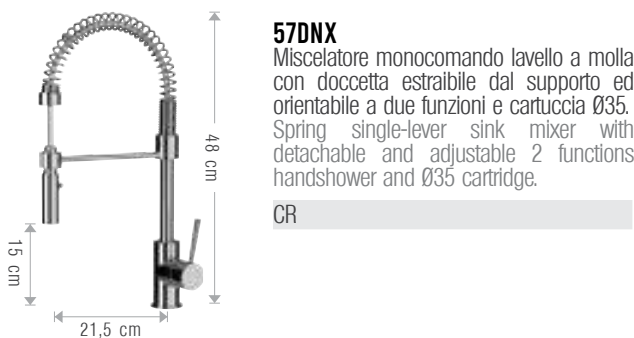



AVENUE

5TH AVENUE

ARMONIA

ULTRAMINIMAL

POLAR

NEXT

RIVER

STILNOVO

585NX





AVENUE

5TH AVENUE

ARMONIA

ULTRAMINIMAL

POLAR

NEXT

RIVER

STILNOVO

RIVER





La collezione RIVER nasce dal desiderio di coniugare uno stile fortemente contemporaneo con l'incanto e l'armonia di una cascata naturale. L'intera serie, marcatamente cubica nelle proporzioni, viene addolcita dalle bocche di erogazione a cascata che permettono di osservare lo scorrere naturale dell'acqua.

Importanti accorgimenti tecnici fanno sì che, indipendentemente dalla pressione dell'impianto, il miscelatore crei un flusso omogeneo e di conseguenza una cascata perfetta.

Tutte le figure della serie River riflettono appieno i principi della produzione di Rubinetterie Mariani: un'estetica elegante ed impeccabile unita a materiali di qualità e ad un alto valore tecnico, per soddisfare il Cliente sotto tutti gli aspetti.

La collezione è dotata di cartuccia a dischi ceramici Ø 35 mm.

River collection comes from the desire to combine an extremely modern style with the charm and the lush of a natural waterfall effect. The entire series, definitely cubic in proportions, is softened by the special slides that allow you to observe the natural water flow.

Special technical solutions allow the mixer to create, regardless of the system pressure, a homogeneous flow and consequently a perfect waterfall.

Each item included in RIVER collection fully reflects the values of Rubinetterie Mariani production: elegant and impeccable shapes, high quality materials and excellent technical value. All combined to please and satisfy the user in every aspect.

The collection is equipped with ceramic disc cartridge Ø 35 mm.

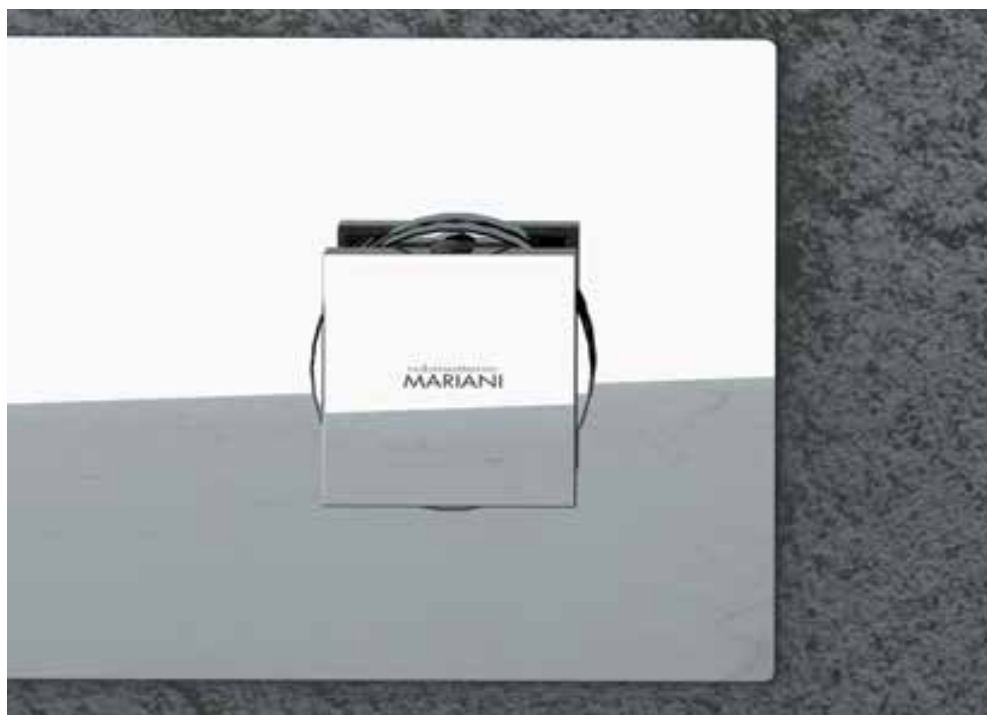

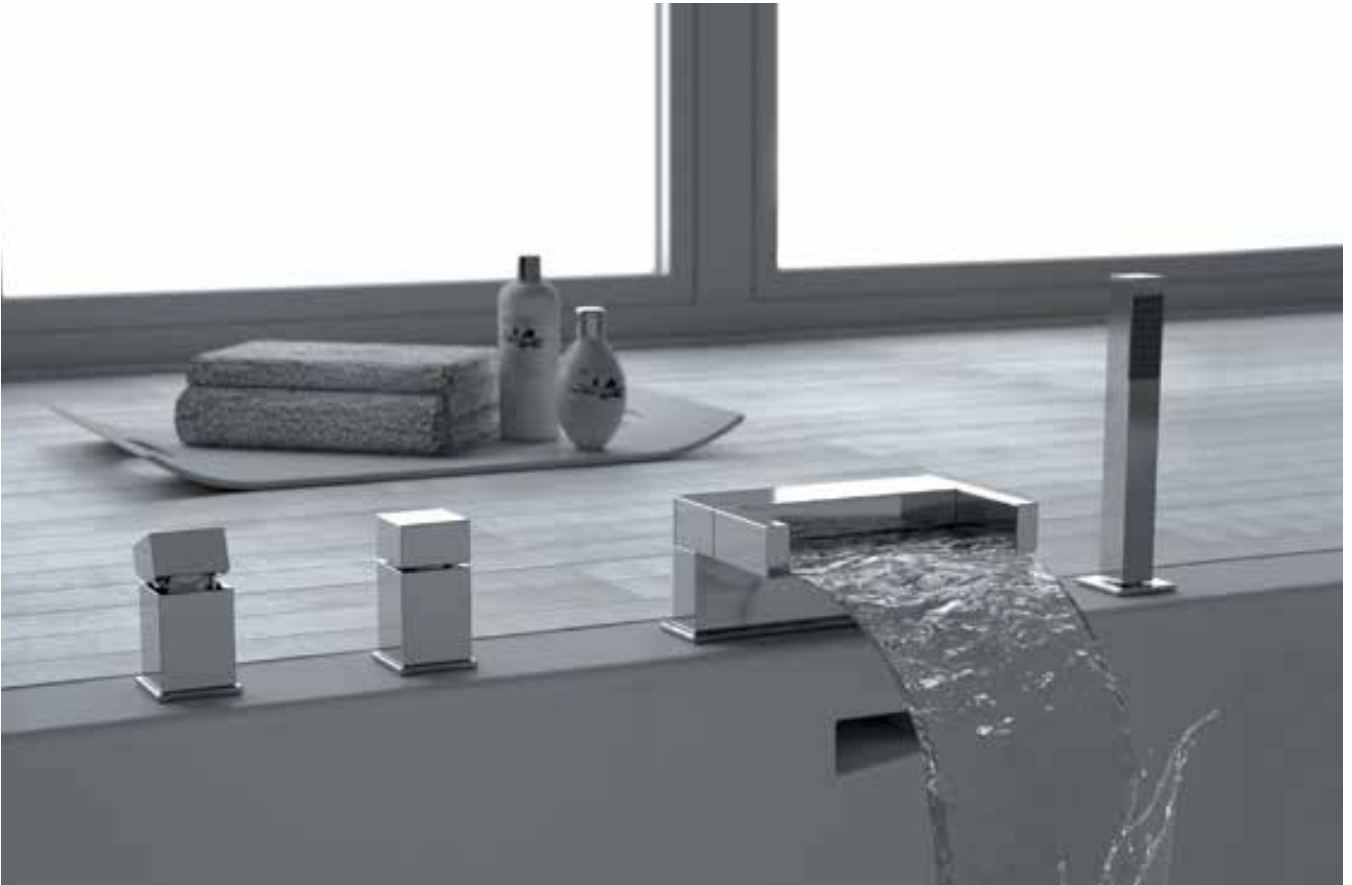

239RI

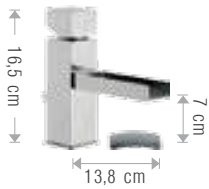

393RI

Miscelatore lavabo con bocca a cascata e scarico.
Washbasin mixer with waterfall spout and pop-up waste.

CR

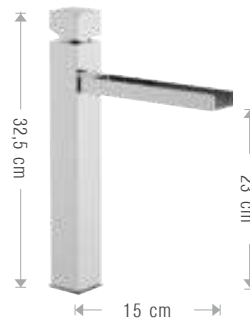

397RI

Miscelatore lavabo alto con bocca a cascata, senza scarico.
High Washbasin mixer with waterfall spout without waste.

CR

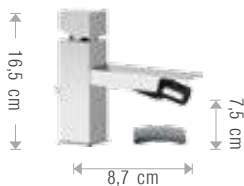

493RI

Miscelatore bidet con scarico e tettuccio estetico brevettato.
Bidet mixer with pop-up waste and patented aesthetic nozzle cover.

CR

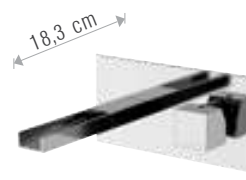

565RI

Miscelatore monocomando a incasso per lavabo, con piastra rettangolare in ottone cromato e bocca quadrata a cascata.
Single-lever built-in basin mixer, with rectangular wall flange in chrome plated brass and waterfall squared spout.

CR

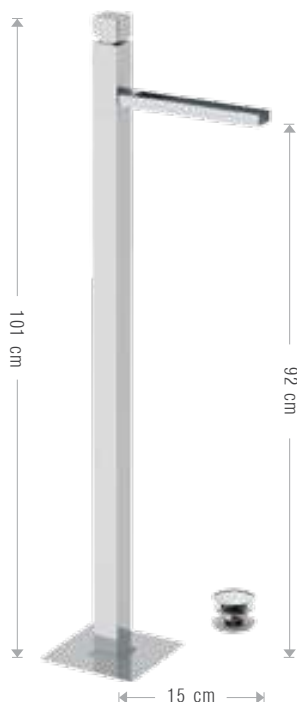

385RI

Miscelatore monocomando lavabo da terra con bocca a cascata con scarico click-clack e troppo pieno.
Single-lever basin mixer floor-mounting with waterfall spout with click-clack waste and overflow.

CR

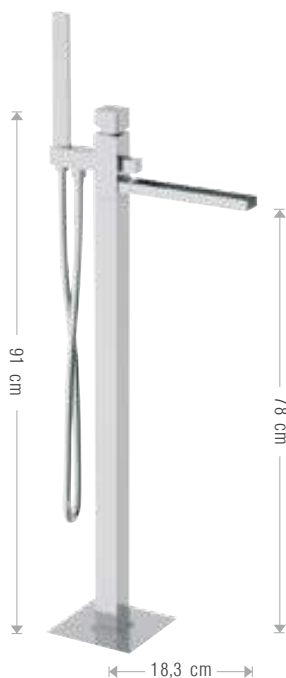

21ARI

Miscelatore vasca da pavimento con bocca a cascata, senza scarico.
freestanding bath mixer with waterfall spout without waste.

CR



230RI

Miscelatore vasca esterno con bocca a cascata, con doccetta completamente cromata in ABS, supporto regolabile e flessibile 150 cm.
Wall mtg. bath/shower mixer with waterfall spout, flexible 150 cm and duplex shower with ABS handshower completely chromed.

CR

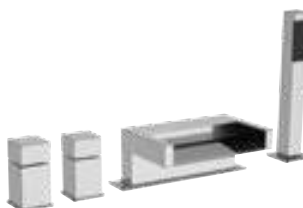

239RI

Batteria bordo vasca 4 fori con deviatore, bocca a cascata e doccetta in ottone cromato.
4 holes deck mounted bath mixer with diverter, waterfall spout and c.p. brass handshower.

CR



212RI

Miscelatore vasca esterno con bocca a cascata, senza Set doccia.
Wall mtg. bath mixer with waterfall spout, without accessories.

CR



252RI

Miscelatore doccia esterno.
Wall mtg. shower mixer, without accessories.

CR

AVENUE

5th AVENUE

ARMONIA

ULTRAMINIMAL

POLAR

NEXT

RIVER

STILNOVO



179RI
 Miscelatore doccia incasso.
 Built-in shower mixer.
 CR



173RI
 Miscelatore doccia incasso con deviatore.
 Built-in shower mixer with diverter.
 CR



173RIP2
 Miscelatore monocomando incasso con deviatore a 2 vie.
 Concealed single-lever shower mixer with 2 ways diverter.
 CR



173RIP3
 Miscelatore monocomando incasso con deviatore a 3 vie.
 Concealed single-lever shower mixer with 3 ways diverter.
 CR



13ABC
 Bocca incasso a cascata.
 Waterfall built-in spout.
 CR

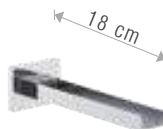

130RI
 Bocca incasso a cascata.
 Waterfall built-in spout.
 CR



130DC
 Bocca a cascata ad incasso in Acciaio Inox.
 Waterfall built-in spout, stainless steel.
 CR



17BRIP3SR002
 Set doccia composto da: miscelatore a incasso con deviatore a 3 vie (173RIP3); soffione a parete 50x20 cm con getto a pioggia, in acciaio INOX lucidato (SR002); doccetta minimale quadrata a 1 funzione, in ottone (191PF); presa acqua con supporto fisso (242PA); bocca a cascata ad incasso 14,5x30 cm (13BBC); flessibile 150 cm.
 Shower set including: built-in mixer with 3-way diverter (173RIP3); 50x20 cm wall shower head with rain jet, in polished stainless steel (SR002); 1-function squared hand shower, in brass (191PF); brass connection pipe with shower holder (242PA); built-in waterfall spout, 14,5x30 cm (13BBC); 150 cm flexible hose.
 CR



13BBC
 Bocca a cascata ad incasso in Acciaio Inox.
 Waterfall built-in spout, stainless steel.
 CR



138PA
 Bocca bordo vasca a cascata.
 Waterfall spout for deck bath mixer.
 CR



AVENUE

5TH AVENUE

ARMONIA

ULTRAMINIMAL

POLAR

NEXT

RIVER

STILNOVO

17BRIP3SR002





STILNOVO

RIVER

NEXT

POLAR

ULTRAMINIMAL

ARMONIA

5TH AVENUE

AVENUE

STILNOVO

**91BSN**

Bocca da soffitto in ottone cromato
lunghezza 166 cm.
Ceiling spout in chrome plated brass cm
166.

CR

91BSNL

Bocca da soffitto in ottone cromato
lunghezza 181 cm.
Ceiling spout in chrome plated brass cm
181.

CR

Da abbinare agli incassi doccia.
To be combined with concealed shower
mixers.

**91ASN**

Miscelatore da soffitto in ottone cromato
lunghezza 166 cm con miscelazione e
controllo flusso integrati nella bocca di
erogazione.

Ceiling mixer in chrome plated brass
cm 166, with mixing and flow control
integrated in the outlet spout.

CR

91ASNL

Miscelatore da soffitto in ottone cromato
lunghezza 181 cm con miscelazione e
controllo flusso integrati nella bocca di
erogazione.

Ceiling mixer in chrome plated brass
cm 181, with mixing and flow control
integrated in the outlet spout.

CR

91ASNXL

Miscelatore da soffitto in ottone cromato
lunghezza 231 cm con miscelazione e
controllo flusso integrati nella bocca di
erogazione.

Ceiling mixer in chrome plated brass
cm 231, with mixing and flow control
integrated in the outlet spout.

CR

STILNOVO LIGHT

**91BSNR**

Bocca da soffitto in ottone cromato
lunghezza 166 cm.
Ceiling spout in chrome plated brass cm
166.

CR

91BSNRL

Bocca da soffitto in ottone cromato
lunghezza 181 cm.
Ceiling spout in chrome plated brass cm
181.

CR

Da abbinare agli incassi doccia.
To be combined with concealed shower
mixers.

**91ASNR**

Miscelatore da soffitto in ottone cromato
lunghezza 166 cm con miscelazione e
controllo flusso integrati nella bocca di
erogazione, con luce LED.

Ceiling mixer in chrome plated brass
cm 166, with mixing and flow control
integrated in the outlet spout, with LED
light device

CR

91ASNRL

Miscelatore da soffitto in ottone cromato
lunghezza 181 cm con miscelazione e
controllo flusso integrati nella bocca di
erogazione, con luce LED.

Ceiling mixer in chrome plated brass
cm 181, with mixing and flow control
integrated in the outlet spout.

CR

91ASNRLXL

Miscelatore da soffitto in ottone cromato
lunghezza 231 cm con miscelazione e
controllo flusso integrati nella bocca di
erogazione, con luce LED.

Ceiling mixer in chrome plated brass
cm 231, with mixing and flow control
integrated in the outlet spout.

CR



91BSNR

Il prodotto è disponibile in due varianti denominate **A** e **D**, di seguito dettagliate.

Per evidenziare la Vostra scelta, specificare la lettera della variante.

The product is available in two variants named **A** and **D**, that we detail here following.

To highlight your selection please indicate the right letter.

A**91ASNR**

La luce emanata cambia colore al variare della temperatura

Blu : fino a 28°
Verde : da 28° a 38°
Giallo: da 38° a 44°
Rosso: da 44°

The light emitted changes color with temperature

Blue : up to 28°
Green: from 28° to 38°
Yellow: from 38° to 44°
Red: from 44°

D**91DSNR**

Un arcobaleno di colori e sfumature si alternano creando un continuo gioco emozionale

A rainbow of colors and shades alternate, creating a constant emotional game

INOX COLLECTION INOX COLLECTION INOX
INOX COLLECTION INOX COLLECTION INOX
INOX COLLECTION INOX COLLECTION INOX
INOX COLLECTION INOX COLLECTION INOX
INOX COLLECTION INOX COLLECTION INOX
INOX COLLECTION INOX COLLECTION INOX
INOX COLLECTION INOX COLLECTION INOX
INOX COLLECTION INOX COLLECTION INOX
INOX COLLECTION INOX COLLECTION INOX
INOX COLLECTION INOX COLLECTION INOX
INOX COLLECTION INOX COLLECTION INOX
INOX COLLECTION INOX COLLECTION INOX
INOX COLLECTION INOX COLLECTION INOX
INOX COLLECTION INOX COLLECTION INOX
INOX COLLECTION INOX COLLECTION INOX
INOX COLLECTION INOX COLLECTION INOX
INOX COLLECTION INOX COLLECTION INOX
INOX COLLECTION INOX COLLECTION INOX
INOX COLLECTION INOX COLLECTION INOX
INOX COLLECTION INOX COLLECTION INOX

INOX COLLECTION

INOX COLLECTION INOX COLLECTION INOX
INOX COLLECTION INOX COLLECTION INOX
INOX COLLECTION INOX COLLECTION INOX
INOX COLLECTION INOX COLLECTION INOX





ULTRAMINIMAL 316





ULTRAMINIMAL 316 è una collezione di miscelatori monocomando dal design estremamente minimale, valorizzata dalla qualità estetica e pratica dell'acciaio INOX AISI 316 con effetto spazzolato.

La stanza da bagno assume così il carattere e la lucentezza innata di una rubinetteria inossidabile, creando ambientazioni raffinate e marcatamente moderne.

La collezione è dotata di cartuccia a dischi ceramici Ø 25 mm per lavabo e bidet e Ø 35 mm per incassi doccia. Prodotto realizzato in acciaio INOX AISI 316. Finitura spazzolata.

ULTRAMINIMAL 316 is a single-lever mixers collection with an extremely minimal design, enhanced by the aesthetic and practical quality of stainless steel with a brushed effect.

The bathroom thus assumes the innate character and brilliance of the stainless faucets, creating fine and decidedly modern settings.

The collection is equipped with ceramic disc cartridge, Ø 25 mm for basin and bidet and Ø 35 mm for shower mixer. Made of AISI 316 stainless steel. Brushed finishing.



OPZIONI DI FINITURA

L'asta della leva di miscelazione nella collezione ULTRAMINIMAL 316 è disponibile con 3 opzioni di finitura, oltre all'acciaio spazzolato: nero opaco, rosso opaco e bianco opaco. Indicare il codice della finitura al momento dell'ordine.



ULTRAMINIMAL 316

FINISHING OPTIONS

The mixing lever rod in the ULTRAMINIMAL 316 collection is available with 3 finishing options, in addition to brushed steel: matt black, matt red and matt white. Refer to the finishing code when ordering.



Acciaio INOX spazzolato,
asta della maniglia nero opaco
Brushed stainless steel,
matt black handle rod

.ON



Acciaio INOX spazzolato,
asta della maniglia rosso opaco
Brushed stainless steel,
Matt Red handle rod

.OR



Acciaio INOX spazzolato,
asta della maniglia bianco opaco
Brushed stainless steel,
matt white handle rod

.OB



398UMX



382UMX

Miscelatore monocomando lavabo con scarico click-clack.
Single-lever basin mixer with click-clack waste.

CR _____
FIN (.ON .OR .OB) _____



398UMX

Miscelatore monocomando lavabo alto senza scarico.
High basin mixer without waste.

CR _____
FIN (.ON .OR .OB) _____



380UMX

Miscelatore monocomando lavabo senza scarico e senza foro sul corpo.
Single-lever basin mixer without waste and without body hole.

CR _____
FIN (.ON .OR .OB) _____



565UMXP

Miscelatore monocomando a incasso per lavabo su doppia piastra.
Single-lever built-in basin mixer with double flange.

CR _____
FIN (.ON .OR .OB) _____

**482UMX**

Miscelatore monocomando bidet con scarico click-clack.
Single-lever bidet mixer with click-clack waste.

CR

FIN (.ON .OR .OB)

**480UMX**

Miscelatore monocomando bidet senza scarico e senza foro sul corpo.
Single-lever bidet mixer without waste and without body hole.

CR

FIN (.ON .OR .OB)

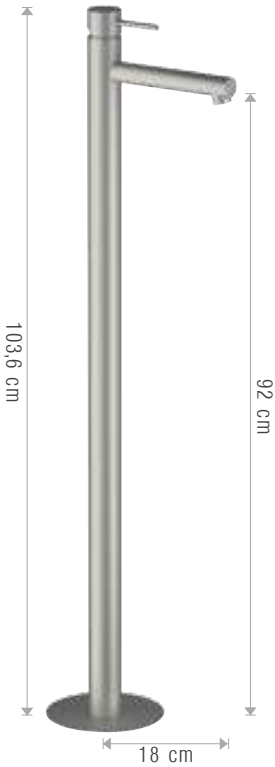
**385UMX**

Miscelatore monocomando lavabo da pavimento senza scarico.
Single-lever basin mixer floor-mounting without waste.

CR

FIN (.ON .OR .OB)

**21AUMX**

Miscelatore monocomando vasca da pavimento con doccia.
Single-lever bath mixer floor-mounting with shower.

CR

FIN (.ON .OR .OB)

**179UMX**

Miscelatore monocomando incasso.
Concealed single-lever shower mixer.

CR

FIN (.ON .OR .OB)

**173UMXPP2**

Miscelatore monocomando incasso con deviatore a 2 vie.
Concealed single-lever shower mixer with 2 ways diverter.

CR

FIN (.ON .OR .OB)

**173UMXPP3**

Miscelatore monocomando incasso con deviatore a 3 vie.
Concealed single-lever shower mixer with 3 ways diverter.

CR

FIN (.ON .OR .OB)

**130UMX**

Bocca incasso.
Built-in spout.

CR



270UMX
Termostatico doccia esterno.
Exposed shower thermostatic.

CR



272UMX
Termostatico vasca esterno.
Exposed bath thermostatic.

CR



125UMXQ
Miscelatore doccia incasso termostatico
con deviatore a pulsante su piastra
rettangolare.
Thermostatic built-in shower mixer with
push-button diverter and rectangular
plate.

CR

COLONNE DOCCIA - SHOWER COLUMNS



SSX37UFM35
Colonna doccia con miscelatore esterno
doccia con deviatore integrato, doccetta
ad 1 funzione e soffione Ø25 cm
anticalcare.
Shower column with external shower
mixer with integrated diverter, 1 function
handshower and Ø25 cm shower head.

CR

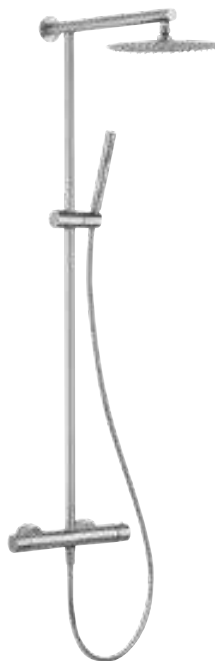

SSXT37UFM35
Colonna doccia con miscelatore esterno
doccia termostatico con deviatore
integrato, doccetta ad 1 funzione e
soffione Ø25 cm anticalcare.
Shower column with external shower
mixer with integrated diverter, 1 function
handshower and Ø25 cm shower head.

CR



ULTRAMINIMAL 316

WELLNESS INOX

KITCHEN INOX

ACCESSORIES INOX

SSXT37UFM35





WELLNESS INOX



Set doccia composto da: miscelatore a incasso con deviatore a 2 vie, su due piastre, in acciaio inox spazzolato (173UMXPP2); soffione ultrapiatto Ø 20 cm in acciaio INOX spazzolato (STXS0120); braccio a parete 30 cm in acciaio INOX spazzolato (BDX0230) asta saliscendi in acciaio spazzolato; doccetta a 1 funzione in acciaio INOX spazzolato (191UMX); presa acqua a muro in acciaio INOX spazzolato (752UMX); flessibile in PVC color acciaio 150 cm.

Shower set including: built-in mixer with 2-way diverter on double plate, in brushed stainless steel (173UMXPP2); Ø 20 cm ultra-flat shower head in brushed stainless steel (STXS0120); 30 cm wall arm in brushed stainless steel (BDX0230) sliding rail in brushed stainless steel; 1-function hand shower in brushed stainless steel (191UMX); wall connection pipe in brushed stainless steel (752UMX); 150 cm flexible hose in steel-colored pvc.

17AUMXPP2TXS20

con soffione doccia Ø 20 cm, con braccio doccia 30 cm
with shower head Ø 20 cm with arm 30 cm;

17AUMXPP2TXS25

con soffione doccia Ø 25 cm, con braccio doccia 30 cm
with shower head Ø 25 cm with arm 30 cm;

17AUMXPP2TXS30

con soffione doccia Ø 30 cm, con braccio doccia 30 cm
with shower head Ø 30 cm with arm 30 cm;



Set doccia composto da: miscelatore a incasso con deviatore a 2 vie, su due piastre, in acciaio inox spazzolato (173UMXPP2); soffione ultrapiatto Ø 20 cm in acciaio INOX spazzolato (STXS0120); braccio a parete 30 cm in acciaio INOX spazzolato (BDX0230) doccetta a 1 funzione in acciaio INOX spazzolato (191UMX); presa acqua con supporto fisso in acciaio INOX spazzolato (242UMX); flessibile in PVC color acciaio 150 cm.

Shower set including: built-in mixer with 2-way diverter on double plate, in brushed stainless steel (173UMXPP2); Ø 20 cm ultra-flat shower head in brushed stainless steel (STXS0120); 30 cm wall arm in brushed stainless steel (BDX0230); 1-function hand shower in brushed stainless steel (191UMX); connection pipe with shower holder in brushed stainless steel (242UMX); 150 cm flexible hose in steel-colored pvc, brushed stainless steel shower mixer, with 2 ways diverter.

17BUMXPP2TXS20

con soffione doccia Ø 20 cm, con braccio doccia 30 cm
with shower head Ø 20 cm with arm 30 cm;

17BUMXPP2TXS25

con soffione doccia Ø 25 cm, con braccio doccia 30 cm
with shower head Ø 25 cm with arm 30 cm;

17BUMXPP2TXS30

con soffione doccia Ø 30 cm, con braccio doccia 30 cm
with shower head Ø 30 cm with arm 30 cm;

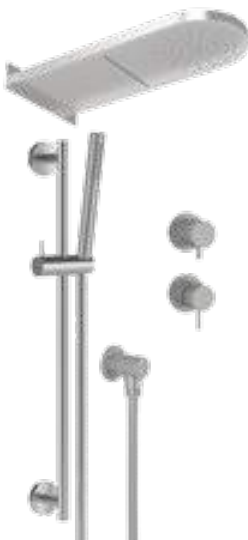

17AUMXPP3SOXS01

Set doccia composto da: miscelatore a incasso con deviatore a 3 vie, su due piastre, in acciaio inox spazzolato (173UMXPP3); soffione a parete 50x20 cm in acciaio INOX spazzolato, 2 getti: pioggia e cascata (SOXS01); asta saliscendi in acciaio spazzolato; doccetta a 1 funzione in acciaio INOX spazzolato (191UMX); presa acqua a muro in acciaio INOX spazzolato (752UMX); flessibile in PVC color acciaio 150 cm.

Shower set including: built-in mixer with 3-way diverter on double plate, in brushed stainless steel (173UMXPP3); 50x20 cm wall shower head in brushed stainless steel, 2 outlets: rain and waterfall (SOXS01); sliding rail in brushed steel; 1-function hand shower in brushed stainless steel (191UMX); wall connection pipe in brushed stainless steel (752UMX); 150 cm flexible hose in steel-colored pvc.

CR

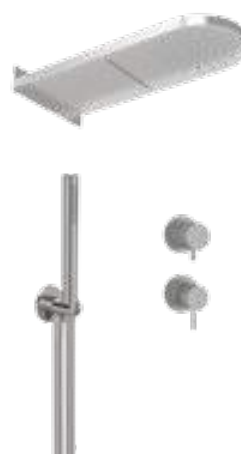

17BUMXPP3SOXS01

Set doccia composto da: miscelatore a incasso con deviatore a 3 vie, su due piastre, in acciaio inox spazzolato (173UMXPP3); soffione a parete 50x20 cm in acciaio INOX spazzolato, 2 getti: pioggia e cascata (SOXS01); doccetta a 1 funzione in acciaio INOX spazzolato (191UMX); presa acqua con supporto fisso in acciaio INOX spazzolato (242UMX); flessibile in PVC color acciaio 150 cm.

Shower set including: built-in mixer with 3-way diverter on double plate, in brushed stainless steel (173UMXPP3); 50x20 cm wall shower head in brushed stainless steel, 2 outlets: rain and waterfall (SOXS01); 1-function hand shower in brushed stainless steel (191UMX); connection pipe in brushed stainless steel with shower holder (242UMX); 150 cm flexible hose in steel-colored pvc.

CR

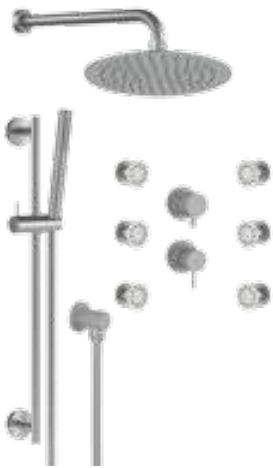

Set doccia composto da: miscelatore a incasso con deviatore a 3 vie, su due piastre, in acciaio inox spazzolato (173UMXPP3); soffione ultrapiatto Ø 20 cm in acciaio INOX spazzolato (STXS0120); braccio a parete 30 cm in acciaio INOX spazzolato (BDX0230) a s t a saliscendi in acciaio spazzolato; doccetta a 1 funzione in acciaio INOX spazzolato (191UMX); presa acqua a muro in acciaio INOX spazzolato (752UMX); 6 getti a muro in acciaio spazzolato orientabili (GTXS01); flessibile in PVC color acciaio 150 cm.

Shower set including: built-in mixer with 3-way diverter on double plate, in brushed stainless steel (173UMXPP3); Ø 20 cm ultra-flat shower head in brushed stainless steel (STXS0120); 30 cm wall arm in brushed stainless steel (BDX0230) sliding rail in brushed steel; 1-function hand shower in brushed stainless steel (191UMX); wall connection pipe in brushed stainless steel (752UMX); 6 adjustable wall jets in brushed steel (GTXS01); 150 cm flexible hose in steel-colored pvc.



Set doccia composto da: miscelatore a incasso con deviatore a 3 vie, su due piastre, in acciaio inox spazzolato (173UMXPP3); soffione ultrapiatto Ø 20 cm in acciaio INOX spazzolato (STXS0120); braccio a parete 30 cm in acciaio INOX spazzolato (BDX0230) doccetta a 1 funzione in acciaio INOX spazzolato (191UMX); presa acqua con supporto fisso in acciaio INOX spazzolato (242UMX); 6 getti a muro in acciaio spazzolato orientabili (GTXS01); flessibile in PVC color acciaio 150 cm.

Shower set including: built-in mixer with 3-way diverter on double plate, in brushed stainless steel (173UMXPP3); Ø 20 cm ultra-flat shower head in brushed stainless steel (STXS0120); 30 cm wall arm in brushed stainless steel (BDX0230) 1-function hand shower in brushed stainless steel (191UMX); connection pipe in brushed stainless steel with shower holder (242UMX); 6 adjustable wall jets in brushed steel (GTXS01); 150 cm flexible hose in steel-colored pvc.

17GUMXPP3TXS20

con soffione doccia Ø 20 cm,
con braccio doccia 30 cm
with shower head Ø 20 cm with
arm 30 cm;

17GUMXPP3TXS25

con soffione doccia Ø 25 cm,
con braccio doccia 30 cm
with shower head Ø 25 cm with
arm 30 cm;

17GUMXPP3TXS30

con soffione doccia Ø 30 cm,
con braccio doccia 30 cm
with shower head Ø 30 cm with
arm 30 cm;

170UMXPP3TXS20

con soffione doccia Ø 20 cm,
con braccio doccia 30 cm
with shower head Ø 20 cm with
arm 30 cm;

170UMXPP3TXS25

con soffione doccia Ø 25 cm,
con braccio doccia 30 cm
with shower head Ø 25 cm with
arm 30 cm;

170UMXPP3TXS30

con soffione doccia Ø 30 cm,
con braccio doccia 30 cm
with shower head Ø 30 cm with
arm 30 cm;

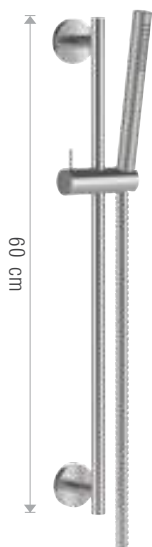
**760UMX**

Saliscendi minimale con doccetta ad 1 funzione completamente in acciaio INOX spazzolato.

Minimal sliding rail set with 1 function handshower completely in brushed stainless steel.

CR



Set doccia composto da: soffione ultrapiatto in acciaio INOX spazzolato (STXS0120); braccio a parete 30 cm in acciaio INOX spazzolato (BDX0230); doccetta a 1 funzione in acciaio INOX spazzolato (191UMX); presa acqua con supporto fisso in acciaio INOX spazzolato (242UMX); flessibile in PVC color acciaio 150 cm. Da abbinare ad un miscelatore a incasso con deviatore (NON INCUSO).

Shower set including: ultra-flat shower head in brushed stainless steel (STXS0120); 30 cm wall arm in brushed stainless steel (BDX0230); 1-function hand shower in brushed stainless steel (191UMX); connection pipe in brushed stainless steel with shower holder (242UMX); 150 cm flexible hose in steel-colored pvc. To be combined with a built-in mixer with diverter (NOT INCLUDED).

249UMX20X con soffione ultrapiatto Ø 20 cm.
with Ø 20 cm ultra-flat shower head.

249UMX25X con soffione ultrapiatto Ø 25 cm.
with Ø 25 cm ultra-flat shower head.

249UMX30X con soffione ultrapiatto Ø 30 cm.
with Ø 30 cm ultra-flat shower head.



Set doccia composto da: soffione ultrapiatto in acciaio INOX spazzolato (SQXS0120); braccio a parete 30 cm in acciaio INOX spazzolato (BDX0230) doccetta rettangolare a 1 funzione in acciaio inox spazzolato (191QDX); presa acqua con supporto fisso in acciaio INOX spazzolato (242UMX); flessibile in PVC color acciaio 150 cm. Da abbinare ad un miscelatore a incasso con deviatore (NON INCUSO).

Shower set including: ultra-flat shower head in brushed stainless steel (SQXS0120); 30 cm wall arm in brushed stainless steel (BDX0230) 1-function rectangular hand shower in brushed stainless steel (191QDX); connection pipe in brushed stainless steel with shower holder (242UMX); 150 cm flexible hose in steel-colored pvc. To be combined with a built-in mixer with diverter (NOT INCLUDED).

249QDX20X con soffione ultrapiatto 20x20 cm.
with 20x20 cm ultra-flat shower head.

249QDX25X con soffione ultrapiatto 25x25 cm.
with 25x25 cm ultra-flat shower head.

249QDX30X con soffione ultrapiatto 30x30 cm.
with 30x30 cm ultra-flat shower head.



Soffione doccia ultra piatto in acciaio INOX spazzolato.
Ultra slim brushed stainless steel shower head.

SQXS0120 20x20cm

SQXS0125 25x25cm

SQXS0130 30x30cm



Soffione doccia ultra piatto in acciaio INOX spazzolato.
Ultra slim brushed stainless steel shower head.

STXS0120 Ø 20cm

STXS0125 Ø 25cm

STXS0130 Ø 30cm



Braccio doccia a soffitto, tondo, acciaio INOX spazzolato.
Brushed stainless steel ceiling round shower arm.

BDX0110 10cm

BDX0120 20cm

BDX0130 30cm



BDX0230

Braccio doccia tondo da parete, in acciaio INOX spazzolato cm 30.
Wall round brushed stainless steel shower arm 30 cm.

CR

**GQXS01**

Body jet a muro per Set doccia multigetti, ultrapiatto 5x5 cm in acciaio INOX spazzolato, anticalcare orientabile ed ispezionabile.
Orientable and inspectable with anti-limestone side body jet for shower multijet kit, ultraflat 5x5 cm brushed stainless steel.

CR

**GTXS01**

Body jet a muro per Set doccia multigetti, ultrapiatto Ø 5 cm in acciaio INOX spazzolato, anticalcare orientabile ed ispezionabile.
Orientable and inspectable with anti-limestone side body jet for shower multijet kit, ultraflat Ø 5 cm brushed stainless steel.

CR

**242UMX**

Presca acqua con supporto fisso in ottone per doccia e attacco da 1/2" per flessibile.
Connection pipe with c.p. brass shower holder and 1/2" connection for flexible.

CR

**146UMX**

Supporto fisso in acciaio INOX spazzolato per doccia.
Brushed stainless steel shower holder.

CR

**752UMX**

Attacco presa acqua minimale da 1/2" in acciaio INOX spazzolato per flessibile doccia.
Brushed stainless steel minimal angular connection pipe 1/2" for flexible.

CR

**W002132800**

Flessibile per doccia retinato metallizzato in pvc atossico, con attacco doppio brillante conico, acciaio inox spazzolato.
Flexible hose for shower with net working metal colour, in atoxic pvc, with double conical shiny brilliant nut, brushed stainless steel.

CR

**191UMX**

Doccetta "Ultraminimal 316" 1 getto in acciaio INOX spazzolato.
Brushed stainless steel "Ultraminimal 316" handshower.

CR

**191QDX**

Doccetta rettangolare minimale ultrapiatta in acciaio INOX, 1 funzione.
Extraflat minimal rectangular shower hand in stainless steel, 1 function.

CR

**700UMX**

Sifone in acciaio inox per lavabo, 1 1/4, canotto cm 30 e rosone pesante.
Stainless steel trap for wash-basin, 1 1/4, outlet tube cm 30 and heavy flange.

CR

**440UMX**

Scarico automatico universale in acciaio inox con chiusura click-clack da 1 1/4.
Universal automatic stainless steel pop-up waste with 1 1/4 click-clack system.

CR

CROMOTERAPIA INOX SPAZZOLATO COLOR THERAPY BRUSHED STAINLESS STEEL

IN DOTAZIONE AI MODELLI - SUPPLIED WITH THE MODELS:



Pulsantiera a parete per accensione luce bianca, selezione colori e cromoterapia automatica.
Wall push-button to turn on white light, colors selection and automatic color therapy.



A RICHIESTA AGGIUNGENDO LA LETTERA "W". - ON REQUEST ADDING THE CODE "W".

Pulsantiera wireless per accensione luce bianca, selezione colori e cromoterapia automatica.
Wireless push-button to turn on white light, colors selection and automatic color therapy.



XSCLQ43



Soffione a soffitto in Acciaio INOX spazzolato 43x43 cm, getto a pioggia anticalcare. Luce LED a 7 colori con 40 sfumature, alimentazione dalla rete elettrica con trasformatore a basso voltaggio incluso (12V). Pulsantiera a parete inclusa.

Ceiling brushed stainless steel shower head 43x43 cm, with antilimestone rain jet. 7 colors light led with 40 shades. Powered by electricity with low voltage transformer included (12V). Wall push-button included.

CR

XSCLQ43W

con pulsantiera wireless inclusa.
with wireless remote control included.

CR

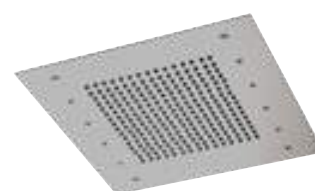

XSCLQ50



Soffione a soffitto in Acciaio INOX spazzolato 50x50 cm, getto a pioggia anticalcare. Luce LED a 7 colori con 40 sfumature, alimentazione dalla rete elettrica con trasformatore a basso voltaggio incluso (12V). Pulsantiera a parete inclusa.

Ceiling brushed stainless steel shower head 50x50 cm, with antilimestone rain jet. 7 colors light led with 40 shades. Powered by electricity with low voltage transformer included (12V). Wall push-button included.

CR

XSCLQ50W

con pulsantiera wireless inclusa.
with wireless remote control included.

CR



XSCLQ43NC



Soffione a soffitto in Acciaio INOX spazzolato 43x43 cm, con 3 funzioni: getto a pioggia anticalcare, nebulizzazione (4 uscite) e getto a cascata. Luce LED a 7 colori con 40 sfumature, alimentazione dalla rete elettrica con trasformatore a basso voltaggio incluso (12V). Pulsantiera a parete inclusa.

Ceiling brushed stainless steel shower head 43x43 cm, with 3 functions: antilimestone rain jet, nebulization (4 outlets) and 1 waterfall jet. 7 colors light led with 40 shades. Powered by electricity with low voltage transformer included (12V). Wall push-button included.

CR

XSCLQ43NCW

con pulsantiera wireless inclusa.
with wireless remote control included.

CR



XSCLQ50NC

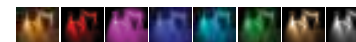

Soffione a soffitto in Acciaio INOX spazzolato 50x50 cm, con 3 funzioni: getto a pioggia anticalcare, nebulizzazione (4 uscite) e getto a cascata. Luce LED a 7 colori con 40 sfumature, alimentazione dalla rete elettrica con trasformatore a basso voltaggio incluso (12V). Pulsantiera a parete inclusa.

Ceiling brushed stainless steel shower head 50x50 cm, with 3 functions: antilimestone rain jet, nebulization (4 outlets) and 1 waterfall jet. 7 colors light led with 40 shades. Powered by electricity with low voltage transformer included (12V). Wall push-button included.

CR

XSCLQ50NCW

con pulsantiera wireless inclusa.
with wireless remote control included.

CR



SOXS01

SOFFIONI INOX SPAZZOLATO A PARETE BRUSHED STAINLESS STEEL WALL SHOWER HEAD

**SOXS01**

Soffione doccia a parete 50x20 cm, in acciaio INOX spazzolato 2 getti: pioggia e cascata.
Wall brushed stainless steel shower head 50x20 cm, 2 jets: rain and waterfall.

CR

**SOXS02**

Soffione doccia a parete 50x20 cm, in acciaio INOX spazzolato, con getti anticalcare.
Wall-mounted shower head 50x20 cm, in brushed stainless steel, with anti-limescale jets.

CR

**SRXS03**

Soffione doccia anticalcare a parete 50x20 cm, in acciaio INOX spazzolato, 2 funzioni: getto a pioggia e cascata.
Wall-mounted anti-limescale shower head 50x20 cm, in brushed stainless steel, 2 functions: rain and waterfall jet

CR

**SRXS02**

Soffione doccia a parete 50x20 cm, in acciaio INOX spazzolato, con getti anticalcare.
Wall-mounted shower head 50x20 cm, in brushed stainless steel, with anti-limescale jets.

CR

**SRXS05**

Soffione doccia anticalcare ultrapiatto 50x25 cm, a parete in acciaio INOX spazzolato, 2 funzioni: getto a pioggia e cascata.
Ultra-flat anti-limescale shower head, 50x25 cm, wall-mounted in brushed stainless steel, 2 functions: rain and waterfall jet

CR

**SRXS04**

Soffione doccia ultrapiatto a parete, 50x20 cm, in acciaio INOX spazzolato.
Wall-mounted ultra-flat shower head, 50x20 cm, in brushed stainless steel.

CR

SOFFIONI INOX SPAZZOLATO A SOFFITTO CON TELAIO BRUSHED STAINLESS STEEL CEILING SHOWER HEAD WITH FIXING SET



XSSSQ43

Soffione a soffitto in Acciaio INOX spazzolato, getti anticalcare, 43x43 cm con getto a pioggia.
Ceiling brushed stainless steel shower head, antilimestone jets, 43x43 cm, with rain jet.

CR



XSSSQ50

Soffione a soffitto in Acciaio INOX spazzolato, getti anticalcare, 50x50 cm con getto a pioggia.
Ceiling brushed stainless steel shower head, antilimestone jets, 50x50 cm, with rain jet.

CR



XSSSR70

Soffione a soffitto in Acciaio INOX, getti anticalcare, 70x40 cm, 2 postazioni pioggia.
Ceiling stainless steel mirror polished shower head, antilimestone jets, 70x40 cm, with 2 rain jet workstations.

CR



XSSSQ43C

Soffione a soffitto in Acciaio INOX spazzolato, getti anticalcare, 43x43 cm, a 2 funzioni: pioggia e cascata.
Ceiling brushed stainless steel shower head, antilimestone jets, 43x43 cm, 2 functions: rain and waterfall.

CR



XSSSQ50C

Soffione a soffitto in Acciaio INOX spazzolato, getti anticalcare, 50x50 cm, a 2 funzioni: pioggia e cascata.
Ceiling brushed stainless steel shower head, antilimestone jets, 50x50 cm, 2 functions: rain and waterfall.

CR



XSSSR70C

Soffione a soffitto in Acciaio INOX, getti anticalcare, 70x40 cm, a 2 funzioni: 2 postazioni pioggia, ed un getto a cascata centrale.
Ceiling stainless steel shower head, antilimestone jets, 70x40 cm, with 2 functions: 2 rain jet workstations and a central waterfall jet.

CR



XSSSQ43NC

Soffione a soffitto in Acciaio INOX spazzolato, getti anticalcare, 43x43 cm, a 3 funzioni: pioggia, nebulizzazione (4 uscite) ed 1 getto a cascata.
Ceiling brushed stainless steel shower head, antilimestone jets, 43x43 cm, 3 functions: rain jet, nebulization (4 outlet) and waterfall.

CR



XSSSQ50NC

Soffione a soffitto in Acciaio INOX spazzolato, getti anticalcare, 50x50 cm, a 3 funzioni: pioggia, nebulizzazione (4 uscite) ed 1 getto a cascata.
Ceiling brushed stainless steel shower head, antilimestone jets, 50x50 cm, 3 functions: rain, nebulization (4 outlet) and waterfall.

CR



XSSSR70NC

Soffione a soffitto in Acciaio INOX spazzolato, getti anticalcare, 70x40 cm, 3 funzioni: 2 postazioni pioggia, nebulizzazione (4 uscite), ed un getto a cascata centrale.
Ceiling brushed stainless steel shower head, antilimestone jets, 70x40 cm, 3 functions: 2 rain jet workstation, nebulization (4 outlets) and a central waterfall jet.

CR

SOFFIONI INOX SPAZZOLATO "SMART FIX"
BRUSHED STAINLESS STEEL "SMART FIX" SHOWER HEADS

**XSSF34**

Soffione doccia SMART FIX in acciaio INOX spazzolato Ø34 cm. Con getti anticalcare.
SMART FIX brushed stainless steel shower head Ø34 cm. With antilimestone jets.

CR

**XSSFQ34**

Soffione doccia SMART FIX in acciaio INOX spazzolato 34x34 cm. Con getti anticalcare.
SMART FIX brushed stainless steel shower head 34x34 cm. With antilimestone jets.

CR

**XSSF44**

Soffione doccia SMART FIX in acciaio INOX spazzolato Ø44 cm. Con getti anticalcare.
SMART FIX brushed stainless steel shower head Ø44 cm. With antilimestone jets.

CR

**XSSFQ44**

Soffione doccia SMART FIX in acciaio INOX spazzolato 44x44 cm. Con getti anticalcare.
SMART FIX brushed stainless steel shower head 44x44 cm. With antilimestone jets.

CR

Per questa tipologia di soffione e con questo specifico sistema di fissaggio sono previste quattro molle per ogni soffione.
For this kind of shower-head with this specific mounting system are expected four springs for each shower head.

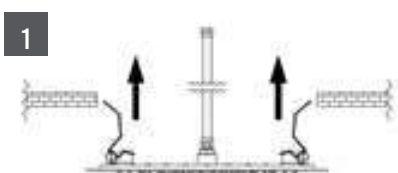

Nell'immagine 1 si evidenzia il primo movimento necessario: caricare due molle vicine tra loro mettendole quasi in posizione verticale rispetto al soffione ed inserirle all'interno del foro precedentemente preparato. Rilasciare le stesse delicatamente.

In picture 1, you shall see the first needed movement to activate them: load two springs close each other placing them vertically in relation to the shower head and insert them in the hole in the ceiling; Release them gently;

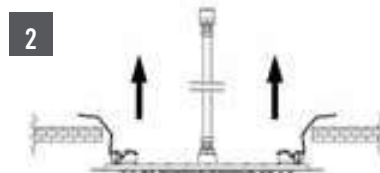

Mantenendo il soffione leggermente inclinato procedere caricando ed inserendo le rimanenti due molle come da immagine 2.
Keeping the shower head slightly inclined, proceed by loading and inserting the two other springs as shown in picture 2.



A questo punto rilasciare delicatamente le molle alla loro naturale tensione e, trattenendo esternamente il soffione, accompagnare lo stesso verso il totale appoggio al soffitto come da immagine 3.

Now release the springs back to their natural tension and, holding the shower head externally, guide it to its final position as shown in picture 3.





KITCHEN INOX

CUCINA INOX SPAZZOLATO
BRUSHED STAINLESS STEEL KITCHEN



506UMX

Miscelatore monocomando per lavello, con bocca girevole, areatore anticalcare M22x1, acciaio inox spazzolato 316L.
Single-lever sink mixer, with swivel spout, M22x1 anti-limescale aerator, brushed stainless steel 316L.

CR



507UMX

Miscelatore monocomando per lavello in acciaio inox 316L spazzolato, canna quadra a "U" girevole.
Single-lever sink mixer in brushed 316L stainless steel, square "U" swivel spout.

CR



518UMX3

Miscelatore monocomando per lavello, con bocca girevole, areatore anticalcare M22x1, acciaio inox spazzolato 316L.
Single-lever sink mixer, with swivel spout, M22x1 anti-limescale aerator, brushed stainless steel 316L.

CR



518UMX1

Miscelatore monocomando per lavello in acciaio inox 316L spazzolato, canna a "U" girevole con flessibile rivestito in gomma soft-touch nero opaco.
Single-lever sink mixer in brushed 316L stainless steel, "U" swivel spout with flexible hose covered in matt black soft-touch rubber.

CR



585UMX

Miscelatore monocomando per lavello, con bocca girevole, areatore anticalcare M22x1, acciaio inox spazzolato 316L, con doccetta estraibile.
Single-lever sink mixer, with swivel spout, M22x1 anti-limescale aerator, brushed stainless steel 316L with pull-out hand shower.

CR



ULTRAMINIMAL 316

WELLNESS INOX

KITCHEN INOX

ACCESSORIES INOX

518UMX1





ACCESSORIES INOX



942UMXA

Bicchiere in acciaio INOX AISI 316.
Stainless steel AISI 316 cup.

CR



942UMX

Bicchiere da parete in acciaio INOX AISI 316.

Wall mounted stainless steel AISI 316 cup.

CR



959UMXA

Porta sapone liquido in acciaio INOX AISI 316.
Stainless steel AISI 316 liquid soap holder.

CR



959UMX

Porta sapone liquido da parete in acciaio INOX AISI 316.

Wall mounted stainless steel AISI 316 liquid soap holder.

CR



936UMX

Porta rotolo in acciaio INOX AISI 316.
Stainless steel AISI 316 toilet paper holder.

CR



953UMX

Porta rotolo di scorta in acciaio INOX AISI 316.

Stainless steel AISI 316 spare toilet paper holder.

CR

**941UMXA**

Porta scopino a pavimento in acciaio INOX AISI 316.
Stainless steel AISI 316 floor brush-holder.

CR

**941UMX**

Porta scopino a muro in acciaio INOX AISI 316.
Stainless steel AISI 316 wall mounted brush-holder.

CR

**932UMX**

Porta salvietta cm 60 in acciaio INOX AISI 316.
Stainless steel AISI 316 towel-holder cm 60.

CR

**935UMX**

Porta salvietta cm 30 in acciaio INOX AISI 316.
Stainless steel AISI 316 towel-holder cm 30

CR

**937UMX**

Appendi abiti in acciaio INOX AISI 316.
Stainless steel AISI 316 robe Hook

CR





ARTIC

SURF

SURF ECO

MARTE

HERMÉS

ESSENZA

MAXIMA

EPIC

ARTIC





La collezione di miscelatori ARTIC presenta un design moderno, leggero e attento al dettaglio, tipico delle migliori produzioni Made-in-Italy e specchio della qualità di Rubinetterie Mariani.

Una proposta di rubinetteria monocomando elegante ed esclusiva che, grazie alle moderne tecnologie produttive, riesce a posizionarsi in una fascia di prezzo estremamente competitiva.

La soluzione perfetta per i progetti a budget contenuto che non vogliono rinunciare ad un arredo di stile e di alta qualità.

La collezione è dotata di cartuccia Ø 35 mm Hydromignon by STSR.

ARTIC mixer faucet collection presents a modern design, light and attentive to detail, typical of the best productions Made-in-Italy and mirror of the quality of Rubinetterie Mariani.

An elegant and exclusive proposal for a single-lever mixer which, thanks to modern production technologies, is able to position itself in an extremely competitive price range.

The perfect solution for projects on a budget who do not want to give up a style furniture and high quality.

The collection is equipped with Hydromignon Ø 35 mm cartridge by STSR.

OPZIONI DI FINITURA

La collezione ARTIC è disponibile con 2 diverse opzioni di finitura, oltre al cromato: Nero Opaco (.14), Nichel Spazzolato lucido (.08). Indicare il codice di finitura al momento dell'ordine.



ARTIC

FINISHING OPTIONS

ARTIC collection is available with 3 different finishing options, in addition to chrome: Matt Black (.14), Shiny Brushed Nickel (.08). Refer to the finishing code when ordering.



Nero Opaco
Matt Black

.14



Nichel Spazzolato
Brushed Nickel

.08

ARTIC

SURF

SURF ECO

MARTE

HERMÉS

ESSENZA

MAXIMA

EPIC



A parità di flusso dell'acqua, una maggiore aerazione consente un risparmio idrico fino al 70%.
The same water flow mixed with air gets a water saving up to 70%.

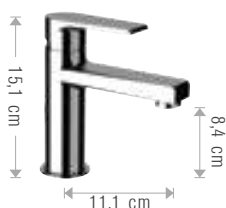

393AT

Miscelatore monocomando lavabo, con scarico.
Single-lever basin mixer, with pop-up waste.
CR

FIN (.14 .08)

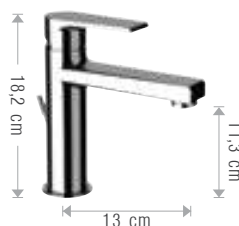

39AAT

Miscelatore monocomando lavabo medio con scarico.
Medium single-lever basin mixer, with pop-up waste.
CR

FIN (.14 .08)



398AT

Miscelatore monocomando lavabo alto XL senza scarico.
High XL single-lever mixer without waste.
CR

FIN (.14 .08)



382AT

Miscelatore monocomando lavabo con bocca alta girevole.
Single-lever mixer for wash basin with high swiveling spout.
CR

FIN (.14 .08)





565AT



565AT
Miscelatore monocomando lavabo ad incasso, completo.
Built-in single-lever basin mixer, complete.

CR
FIN (.14 .08)



565ATE
Solo parte esterna
Only external component

CR
FIN (.14 .08)

565ATINC
Solo parte incasso
Only built-in components

CR
FIN (.14 .08)

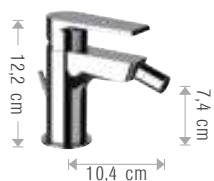

493AT
Miscelatore monocomando bidet, con scarico.
Single-lever bidet mixer, with pop-up waste.

CR
FIN (.14 .08)



252AT
Miscelatore monocomando doccia senza accessori.
Wall mtg. Shower single-lever mixer without accessories.

CR
FIN (.14 .08)



385AT

Miscelatore monocomando lavabo da terra con scarico click-clack e troppo pieno.
Single-lever basin mixer floor-mounting with click-clack waste and overflow.

CR

FIN (.14 .08)



292AT

Miscelatore monocomando vasca con deviatore integrato e Set doccia.
Wall mtg. single-lever bath mixer with integrated diverter and accessories.

CR

293AT

Miscelatore monocomando vasca con deviatore integrato.
Wall mtg. single-lever bath mixer with integrated diverter.

CR



230AT

Miscelatore monocomando vasca con accessori.
Wall mtg. single-lever bath mixer with accessories.

CR

FIN (.14 .08)



212AT

Miscelatore monocomando vasca senza accessori.
Wall mtg. single-lever bath mixer without accessories.

CR

FIN (.14 .08)

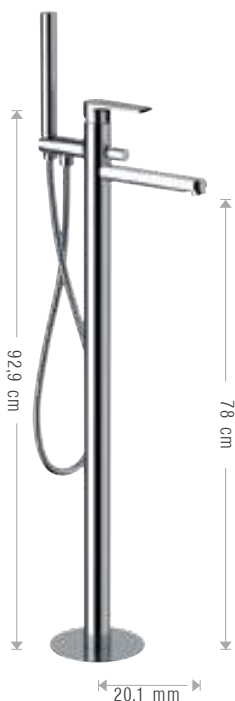

21AAT

Miscelatore monocomando vasca da pavimento.
Single-lever bath mixer floor-mounting.

CR

FIN (.14 .08)



76AD1

Kit composto da: asta saliscendi cromata con doccetta cromata a 5 funzioni con getti in silicone; flessibile 150 cm.
Kit including: c.p. sliding rail with 5-function abs hand shower with silicone jets; 150 cm flexible hose.

CR



237AT

Batteria bordo vasca 3 fori.
3 holes bath shower mixer deck mounted.

CR



76ED9

Kit composto da: asta saliscendi cromata con doccetta a 4 funzioni con pulsante per il cambio dei getti, in abs cromato (191MP); flessibile 150 cm.

Kit including: c.p. sliding rail with 4-function hand shower with button for changing the jets, abs, anti-limescale (191MP); 150 cm flexible hose.

CR



179AT

Miscelatore monocomando incasso, completo.
Concealed single-lever shower mixer, complete.

CR

FIN (.14 .08)



173AT

Miscelatore monocomando incasso con deviatore, completo.
Concealed single-lever shower mixer with diverter, complete.

CR

FIN (.14 .08)

179ATE

Solo parte esterna
Only external component

CR

FIN (.14 .08)

179INC35

Solo parte incasso
Only built-in components

CR

FIN (.14 .08)

173ATE

Solo parte esterna
Only external component

CR

FIN (.14 .08)

173INC35

Solo parte incasso
Only built-in components

CR

FIN (.14 .08)



173ATP2

Miscelatore monocomando per doccia con deviatore a 2 vie su unica piastra, completo.
Single-lever built-in shower mixer with 2 ways diverter on single flange, complete.

CR

FIN (.14 .08)



173ATP3

Miscelatore monocomando per doccia con deviatore a 3 vie su unica piastra, completo.
Single-lever built-in shower mixer with 3 ways diverter on single flange, complete.

CR

FIN (.14 .08)

173ATP2E

Solo parte esterna
Only external component

CR

FIN (.14 .08)

173INCP2

Solo parte incasso
Only built-in components

CR

FIN (.14 .08)

173ATP2E

Solo parte esterna
Only external component

CR

FIN (.14 .08)

173INCP3

Solo parte incasso
Only built-in components

CR

FIN (.14 .08)

ARTIC

SURF

SURF ECO

MARTE

HERMÉS

ESSENZA

MAXIMA

EPIC



260ATATA20

**173ATP4**

Miscelatore monocomando per doccia con deviatore a 4 vie su unica piastra.
Single-lever built-in shower mixer with 4 ways diverter on single flange.

CR

FIN (.14 .08)

173ATP5

Miscelatore monocomando per doccia con deviatore a 5 vie su unica piastra.
Single-lever built-in shower mixer with 5 ways diverter on single flange.

CR

FIN (.14 .08)

**173ATPP4**

Miscelatore monocomando per doccia con deviatore a 4 vie su doppia piastra.
Single-lever built-in shower mixer with 4 ways diverter on double flange.

CR

FIN (.14 .08)

173ATPP5

Miscelatore monocomando per doccia con deviatore a 5 vie su doppia piastra.
Single-lever built-in shower mixer with 5 ways diverter on double flange.

CR

FIN (.14 .08)



Colonna doccia a 3 vie composta da: miscelatore vasca/doccia con deviatore integrato nella bocca; soffione in ABS cromato (STA0120); colonna telescopica in ottone con altezza regolabile; doccetta arcuata a 1 funzione in abs cromato con getti in silicone (191N0); flessibile 150 cm.

3-way shower column including: bath/shower mixer with diverter integrated in the spout; shower head in c.p. abs (STA0120); height-adjustable telescopic brass column; 1-function curved hand shower in c.p. abs with silicone jets (191N0); 150 cm flexible hose.

260ATATA20

con soffione doccia Ø20 cm.
with shower head Ø20 cm.

260ATATA25

con soffione doccia Ø25 cm.
with shower head Ø25 cm.



Colonna doccia a 3 vie composta da: miscelatore vasca/doccia con deviatore integrato nella bocca; soffione ultrapiatto, in acciaio INOX lucidato (ST00120); colonna telescopica in ottone con altezza regolabile; doccetta arcuata a 1 funzione in abs cromato con getti in silicone (191N0); flessibile 150 cm.

3-way shower column including: bath/shower mixer with diverter integrated in the spout; ultra-flat shower head in polished stainless steel (ST00120); height-adjustable telescopic brass column; 1-function curved hand shower in c.p. abs with silicone jets (191N0); 150 cm flexible hose.

260ATATX20

con soffione doccia Ø20 cm.
with shower head Ø20 cm.

260ATATX25

con soffione doccia Ø25 cm.
with shower head Ø25 cm.

ARTIC

SURF

SURF ECO

MARTE

HERMÉS

ESSENZA

MAXIMA

EPIC

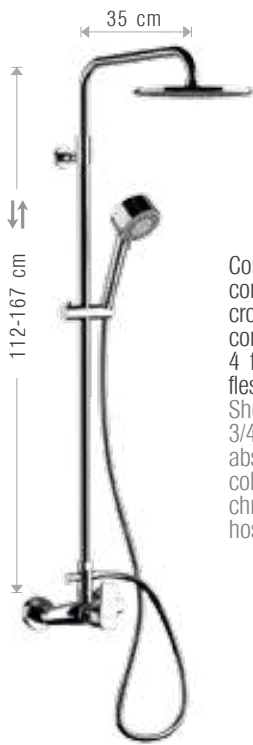

Colonna doccia composta da: miscelatore esterno con attacco alto da 3/4" (259AT); soffione in ABS cromato (STA0120); colonna telescopica in ottone con altezza regolabile, deviatore; doccetta a 4 funzioni in abs cromato con getti in silicone; flessibile 150 cm.

Shower column including: exposed mixer with 3/4" upper connection (259AT); shower head in c.p. abs (STA0120); height-adjustable telescopic brass column with diverter; 4-function hand shower in chromed abs with silicone jets; 150 cm flexible hose.

259ATATA20

con soffione doccia Ø20 cm.
with shower head Ø20 cm.

259ATATA25

con soffione doccia Ø25 cm.
with shower head Ø25 cm.

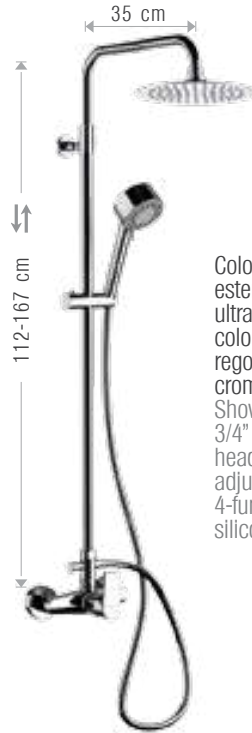

Colonna doccia composta da: miscelatore esterno con attacco alto da 3/4" (259AT); soffione ultrapiatto, in acciaio INOX lucidato (ST00120); colonna telescopica in ottone con altezza regolabile, deviatore; doccetta a 4 funzioni in abs cromato con getti in silicone; flessibile 150 cm.

Shower column including: exposed mixer with 3/4" upper connection (259AT); ultra-flat shower head in polished stainless steel (ST00120); height-adjustable telescopic brass column with diverter; 4-function hand shower in chromed abs with silicone jets; 150 cm flexible hose.

259ATATX20

con soffione doccia Ø20 cm.
with shower head Ø20 cm.

259ATATX25

con soffione doccia Ø25 cm.
with shower head Ø25 cm.



Set doccia composto da: miscelatore a incasso con deviatore (173AT); soffione ultrapiatto, in acciaio INOX lucidato (ST00120); braccio a parete in ottone 30 cm (BD00330); doccetta a 4 funzioni in abs cromato con getti in silicone; presa acqua a muro con supporto fisso (242MN); flessibile 150 cm.

Shower set including: built-in mixer with diverter (173AT); ultra-flat shower head in polished stainless steel (ST00120); 30 cm brass wall arm (BD00330); 4-function hand shower in chromed abs with silicone jets; wall connection pipe with shower holder (242MN); 150 cm flexible hose.

17BATTX20

con soffione doccia Ø20 cm.
with shower head Ø20 cm.

17BATTX25

con soffione doccia Ø25 cm.
with shower head Ø25 cm.



Set doccia composto da: miscelatore a incasso con deviatore (173AT); soffione in ABS cromato (STA0120); braccio a parete in ottone 30 cm (BD00330); doccetta a 4 funzioni in abs cromato con getti in silicone; presa acqua a muro con supporto fisso (242MN); flessibile 150 cm.

Shower set including: built-in mixer with diverter (173AT); shower head in c.p. abs (STA0120); 30 cm brass wall arm (BD00330); 4-function hand shower in chromed abs with silicone jets; wall connection pipe with shower holder (242MN); 150 cm flexible hose.

17BATTX20

con soffione doccia Ø20 cm.
with shower head Ø20 cm.

17BATTX25

con soffione doccia Ø25 cm.
with shower head Ø25 cm.



Set doccia composto da: miscelatore a incasso con deviatore (173AT); soffione ultrapiatto, in acciaio INOX lucidato (ST00120); braccio a parete in ottone 30 cm (BD00330); asta saliscendi cromata; doccetta a 4 funzioni in abs cromato con getti in silicone; presa acqua a muro (752N0); flessibile 150 cm.

Shower set including: built-in mixer with diverter (173AT); ultra-flat shower head in polished stainless steel (ST00120); 30 cm brass wall arm (BD00330); c.p. sliding rail; 4-function hand shower in chromed abs with silicone jets; wall connection pipe (752N0); 150 cm flexible hose.

17AATTX20

con soffione doccia Ø20 cm.
with shower head Ø20 cm.

17AATTX25

con soffione doccia Ø25 cm.
with shower head Ø25 cm.

**17AATTA20**

Set doccia composto da: miscelatore a incasso con deviatore (173AT); soffione Ø 20 cm in ABS cromato (STA0120); braccio a parete in ottone 30 cm (BD00330); asta saliscendi cromata; doccetta a 4 funzioni in abs cromato con getti in silicone; presa acqua a muro (752N0); flessibile 150 cm.

Shower set including: built-in mixer with diverter (173AT); Ø 20 cm shower head in c.p. abs (STA0120); 30 cm brass wall arm (BD00330); c.p. sliding rail; 4-function hand shower in chromed abs with silicone jets; wall connection pipe (752N0); 150 cm flexible hose.

17AATTA20

con soffione doccia Ø20 cm.
with shower head Ø20 cm.

17AATTA25

con soffione doccia Ø25 cm.
with shower head Ø25 cm.

CUCINA - KITCHEN

**584AT**

Miscelatore monocomando per lavello con canna alta girevole e sistema di doccetta monofunzione estraibile.

Single-lever sink mixer with high movable spout and single-function system pull-out hand shower.

CR

**585AT**

Miscelatore monocomando per lavello con canna alta girevole e doccetta estraibile a due funzioni.

Single-lever sink mixer with high movable spout and 2-functions pull-out hand shower.

CR

**506AT**

Miscelatore monocomando lavello, bocca girevole alta.

Single-lever sink mixer with swivel high spout.

CR

**506ATC**

Miscelatore monocomando lavello, con canna corta girevole.

Single-lever sink mixer with short swivel spout.

CR



510AT
 Miscelatore monocomando lavello con bocca alta girevole abbattibile, per sottofinestra.
 Single-lever sink mixer under window model with adjustable swivel spout.
 CR



501AT
 Miscelatore monocomando lavello a parete.
 Wall mtg. single-lever sink mixer.
 CR



571ATB
 Miscelatore monocomando lavello con canna alta girevole.
 Single-lever sink mixer with high swivel spout.
 CR



571ATBC
 Miscelatore monocomando lavello con canna corta girevole.
 Spring single-lever sink mixer with short swivel spout.
 CR

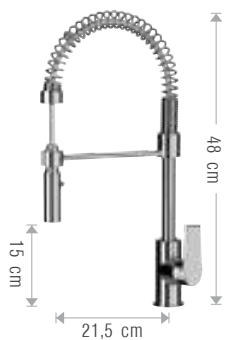

57DAT
 Miscelatore monocomando lavello a molla con doccetta estraibile dal supporto ed orientabile a due funzioni e cartuccia Ø35.
 Spring single-lever sink mixer with detachable and adjustable 2 functions handshower and Ø35 cartridge.
 CR



570AT
 Miscelatore monocomando lavello bocca girevole.
 Single-lever sink mixer with swivel spout.
 CR



505AT
 Miscelatore monocomando lavello a muro, con leva frontale e bocca alta girevole.
 Single-lever wall mounted sink mixer with frontal lever and high swivel spout.
 CR



ARTIC
SURF
SURF ECO
MARTE
HERMÉS
ESSENZA
MAXIMA
EPIC

57DAT

TOUCH-ME



506ATT

Miscelatore monocomando lavello, con canna alta girevole a "U" dotata di tecnologia "Touch-Me" con leva laterale. Dotata di cartuccia Ø35. Single-lever sink mixer with high movable "U" spout equipped with "Touch-Me" system with side lever. Equipped with Ø35 cartridge.

CR



507ATT

Miscelatore monocomando lavello, con canna alta quadrata a "U" e girevole dotata di tecnologia "Touch-Me" con leva laterale. Dotata di cartuccia Ø35. Single-lever sink mixer with squared high movable "U" spout equipped with "Touch-Me" system with side lever. Equipped with Ø35 cartridge.

CR





SURF



Una generazione di miscelatori monocomando di nuova concezione ergonomica, caratterizzati da un design semplice e moderno.
Un dualismo di forme piatte e tonde che si fondono con armonia dando vita ad una linea unica ed esclusiva.

La tecnologia più recente al servizio della qualità e del design, consente a SURF di posizionarsi su una fascia di prezzo competitiva.

La collezione è dotata di cartuccia a dischi ceramici Ø 35 mm.

A generation of single-lever mixers of new ergonomic conception, characterized by a simple and modern design.
A dualism of flat and round shapes that blend with harmony giving life to a unique and exclusive line.

The latest technology at the service of quality and design, allows SURF to be positioned on a competitive price range.

The collection is equipped with ceramic disc cartridge Ø 35 mm.



LEVE DISPONIBILI

La leva di miscelazione nella collezione SURF è disponibile in 3 diversi modelli di design: Surf (.SF), Wind (.WD), Vela (.VA). Indicare il codice di preferenza al momento dell'ordine.



SURF

LEVER OPTIONS

The mixing lever in the SURF collection is available with 3 different design options: Surf (.SF), Wind (.WD), Vela (.VA). Refer to your preference code when ordering.

ARTIC

SURF

SURF ECO

MARTE

HERMÉS

ESSENZA

MAXIMA

EPIC



Surf
.SF

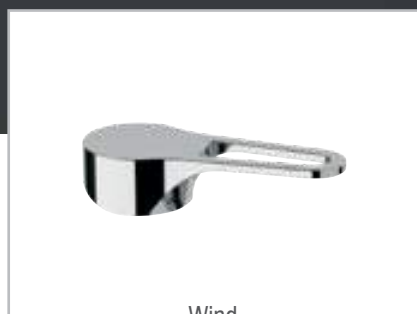

Wind
.WD

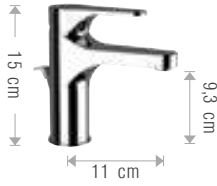

Vela
.VA

**393SF**

Miscelatore monocomando lavabo con scarico.
Single-lever basin mixer with pop-up waste.

CR

**380SF**

Miscelatore monocomando lavabo senza scarico e senza foro nel corpo.
Single-lever basin mixer without waste and without body hole.

CR

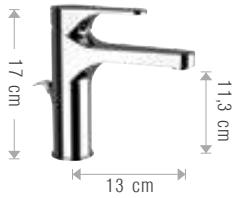
**39ASF**

Miscelatore monocomando lavabo grande con scarico.
High single-lever basin mixer with pop-up waste.

CR

39BSF

Miscelatore monocomando lavabo grande senza scarico e senza foro sul corpo.
High single-lever basin mixer without waste and without body hole.

CR

**385SF**

Miscelatore monocomando lavabo da terra con scarico click-clack e troppo pieno.
Single-lever basin mixer floor-mounting with click-clack waste and overflow.

CR

**398SF**

Miscelatore monocomando lavabo alto XL senza scarico.
XL high single-lever basin mixer without waste.

CR

**305SF**

Miscelatore monocomando lavello a due fori senza scarico.
Two holes single-lever washbasin mixer without waste.

CR

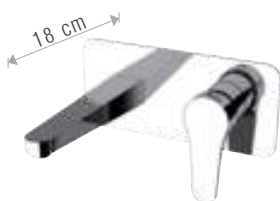

565SF
 Miscelatore monocomando lavabo ad incasso, completo.
 Built-in single-lever basin mixer, complete.

CR



565SFL
 Miscelatore monocomando lavabo ad incasso, completo.
 Built-in single-lever basin mixer, complete.

CR

565SFE

Solo parte esterna
 Only external component

CR

565ATINC

Solo parte incasso
 Only built-in components

CR

565SFE

Solo parte esterna
 Only external component

CR

565ATINC

Solo parte incasso
 Only built-in components

CR



493SF
 Miscelatore monocomando bidet con scarico.
 Single-lever bidet mixer with pop-up waste.

CR



480SF
 Miscelatore monocomando bidet senza scarico.
 Single-lever bidet mixer without waste.

CR



185SFW
 Miscelatore incasso per shut-off comprensivo di doccetta shut-off, supporto doccia, presa acqua, su piastra in ottone cromato e flessibile doccia da 120 cm.
 Built-in shower mixer set including shut-off handshower, connection pipe on flange, completely in c.p. brass and shower flexible 120 cm.

CR



386SF
 Miscelatore monocomando lavabo con doccetta shut-off, scarico click-clack con troppo pieno.
 Single-lever basin mixer with handshower shut-off, with click-clack waste with overflow.

CR



230SF
 Miscelatore monocomando vasca con accessori.
 Wall mtg. single-lever bath mixer with accessories.

CR



212SF
 Miscelatore monocomando vasca senza accessori.
 Wall mtg. single-lever bath mixer without accessories.

CR

ARTIC

SURF

SURF ECO

MARTE

HERMÉS

ESSENZA

MAXIMA

EPIC

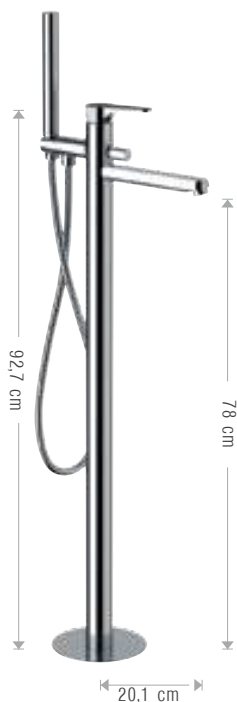

21ASF

Miscelatore monocomando vasca da pavimento.
Single-lever bath mixer floor-mounting.

CR



25ASF

Monocomando esterno doccia con doccetta shut-off in ABS cromato, flessibile conico in ottone cromato 120 cm e gancio.

Wall mounted single-lever shower mixer with shut-off handshower in c.p. ABS, conical flexible in c.p. brass 120 cm and c.p hook.

CR



237SF

Batteria bordo vasca 3 fori.
3 holes bath shower mixer.

CR



231SF

Miscelatore monocomando vasca con accessori, bocca 30 cm.
Wall mtg. single-lever bath mixer with accessories, cm 30 spout.

CR



292SF

Miscelatore monocomando per vasca, con deviatore integrato e Set doccia.

Single-lever bath mixer with diverter and Shower set with handshower.

CR



21ASF



236SF

Batteria bordo vasca 4 fori con bocca con effetto multigetto.
4 holes bath shower mixer with multijet spout.
CR



239SF

Batteria bordo vasca 3 fori con deviatore sul miscelatore e bocca con getto cascata.
3 holes bath shower mixer, with diverter integrated in the mixer and waterfall spout.
CR

**252SF**

Miscelatore monocomando doccia senza accessori.
Wall mtg. single-lever shower mixer without accessories.

CR

**254SF**

Miscelatore monocomando doccia esterno con leva frontale, senza kit doccia.
Wall mounted single-lever shower mixer with frontal lever, without shower kit.

CR

**179SF**

Miscelatore monocomando incasso, completo.
Concealed single-lever shower mixer, complete.

CR

**173SF**

Miscelatore monocomando incasso con deviatore, completo.
Concealed single-lever shower mixer with diverter, complete.

CR

179SFE

Solo parte esterna
Only external component

CR

179INC35

Solo parte incasso
Only built-in components

CR

173SFE

Solo parte esterna
Only external component

CR

173INC35

Solo parte incasso
Only built-in components

CR

**182SF**

Miscelatore monocomando incasso con piastra Lusso, completo.
Concealed single-lever shower mixer with Luxury plate, complete.

CR

**174SF**

Miscelatore monocomando incasso con deviatore con piastra Lusso, completo.
Concealed single-lever shower mixer with diverter with Luxury plate, complete.

CR

182SFE

Solo parte esterna
Only external component

CR

179INC35

Solo parte incasso
Only built-in components

CR

174SFE

Solo parte esterna
Only external component

CR

173INC35

Solo parte incasso
Only built-in components

CR



760SF

Kit composto da: asta saliscendi cromata con doccetta arcuata a 1 funzione in abs cromato con getti in silicone (191N0); flessibile 150 cm.

Kit including: c.p. sliding rail with 1-function curved hand shower in c.p. abs with silicone jets (191N0); 150 cm flexible hose.

CR



130SF

Bocca ad incasso. Concealed spout.

CR



173SFP3

Miscelatore monocomando per doccia con deviatore a 3 vie su unica piastra, completo.

Single-lever built-in shower mixer with 3 ways diverter on single flange, complete.

CR



173SFP2

Miscelatore monocomando per doccia con deviatore a 2 vie su unica piastra, completo.

Single-lever built-in shower mixer with 2 ways diverter on single flange, complete.

CR

173SFP2E

Solo parte esterna
Only external component

CR

173INCP3

Solo parte incasso
Only built-in components

CR

173SFP2E

Solo parte esterna
Only external component

CR

173INCP2

Solo parte incasso
Only built-in components

CR



173SFP4

Miscelatore monocomando per doccia con deviatore a 4 vie su unica piastra.

Single-lever built-in shower mixer with 4 ways diverter on single flange.

CR

173SFP5

Miscelatore monocomando per doccia con deviatore a 5 vie su unica piastra.

Single-lever built-in shower mixer with 5 ways diverter on single flange.

CR

ARTIC

SURF

SURF ECO

MARTE

HERMÉS

ESSENZA

MAXIMA

EPIC

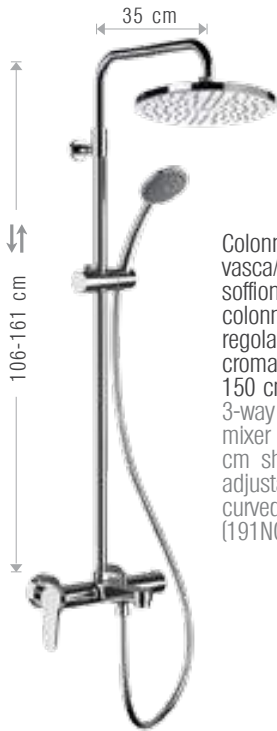

Colonna doccia a 3 vie composta da: miscelatore vasca/doccia con deviatore integrato nella bocca; soffione Ø 20 cm in ABS cromato (STA0120); colonna telescopica in ottone con altezza regolabile; doccetta arcuata a 1 funzione in abs cromato con getti in silicone (191N0); flessibile 150 cm.

3-way shower column including: bath/shower mixer with diverter integrated in the spout; Ø 20 cm shower head in c.p. abs (STA0120); height-adjustable telescopic brass column; 1-function curved hand shower in c.p. abs with silicone jets (191N0); 150 cm flexible hose.

260SFATA20

con soffione doccia Ø20 cm.
with shower head Ø20 cm.

260SFATA25

con soffione doccia Ø25 cm.
with shower head Ø25 cm.

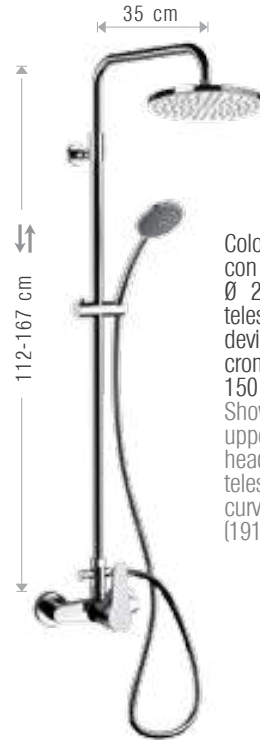

Colonna doccia composta da: miscelatore esterno con attacco superiore da 3/4" (259SF); soffione Ø 20 cm in ABS cromato (STA0120); colonna telescopica in ottone con altezza regolabile, deviatore; doccetta arcuata a 1 funzione in abs cromato con getti in silicone (191N0); flessibile 150 cm.

Shower column including: exposed mixer with upper 3/4" connection (259SF); Ø 20 cm shower head in c.p. abs (STA0120); height-adjustable telescopic brass column with diverter; 1-function curved hand shower in c.p. abs with silicone jets (191N0); 150 cm flexible hose.

259SFATA20

con soffione doccia Ø20 cm.
with shower head Ø20 cm.

259SFATA25

con soffione doccia Ø25 cm.
with shower head Ø25 cm.



Set doccia composto da: miscelatore a incasso con deviatore (173SF); soffione ultrapiatto, in acciaio INOX lucidato (ST00120); braccio a parete in ottone 30 cm (BD00330); doccetta arcuata a 1 funzione in abs cromato con getti in silicone (191N0); presa acqua a muro con supporto fisso (242MN); flessibile 150 cm.

Shower set including: built-in mixer with diverter (173SF); ultra-flat shower head in polished stainless steel (ST00120); 30 cm brass wall arm (BD00330); 1-function curved hand shower in c.p. abs with silicone jets (191N0); wall connection pipe with shower holder (242MN); 150 cm flexible hose.

17BSFTX20

con soffione doccia Ø20 cm.
with shower head Ø20 cm.

17BSFTX25

con soffione doccia Ø25 cm.
with shower head Ø25 cm.



Set doccia composto da: miscelatore a incasso con deviatore (173SF); soffione in ABS cromato (STA0120); braccio a parete in ottone 30 cm (BD00330); doccetta arcuata a 1 funzione in abs cromato con getti in silicone (191N0); presa acqua a muro con supporto fisso (242MN); flessibile 150 cm.

Shower set including: built-in mixer with diverter (173SF); shower head in c.p. abs (STA0120); 30 cm brass wall arm (BD00330); 1-function curved hand shower in c.p. abs with silicone jets (191N0); wall connection pipe with shower holder (242MN); 150 cm flexible hose.

17BSFTA20

con soffione doccia Ø20 cm.
with shower head Ø20 cm.

17BSFTA25

con soffione doccia Ø25 cm.
with shower head Ø25 cm.



Set doccia composto da: miscelatore a incasso con deviatore (173SF); soffione ultrapiatto Ø 20 cm, in acciaio INOX lucidato (ST00120); braccio a parete in ottone 30 cm (BD00330); asta saliscendi cromata; doccetta arcuata a 1 funzione in abs cromato con getti in silicone (191NO); presa acqua a muro (752NO); flessibile 150 cm.

Shower set including: built-in mixer with diverter (173SF); Ø 20 cm ultra-flat shower head in polished stainless steel (ST00120); 30 cm brass wall arm (BD00330); c.p. sliding rail; 1-function curved hand shower in c.p. abs with silicone jets (191NO); wall connection pipe (752NO); 150 cm flexible hose.

17ASFTX20

con soffione doccia Ø20 cm.
with shower head Ø20 cm.

17ASFTX25

con soffione doccia Ø25 cm.
with shower head Ø25 cm.



Set doccia composto da: miscelatore a incasso con deviatore (173SF); soffione Ø 20 cm in ABS cromato (STA0120); braccio a parete in ottone 30 cm (BD00330); asta saliscendi cromata; doccetta arcuata a 1 funzione in abs cromato con getti in silicone (191NO); presa acqua a muro (752NO); flessibile 150 cm.

Shower set including: built-in mixer with diverter (173SF); Ø 20 cm shower head in c.p. abs (STA0120); 30 cm brass wall arm (BD00330); c.p. sliding rail; 1-function curved hand shower in c.p. abs with silicone jets (191NO); wall connection pipe (752NO); 150 cm flexible hose.

17ASFTA20

con soffione doccia Ø20 cm.
with shower head Ø20 cm.

17ASFTA25

con soffione doccia Ø25 cm.
with shower head Ø25 cm.

CUCINA - KITCHEN

**506SF**

Miscelatore monocomando lavello, bocca girevole alta.
Single-lever sink mixer with swivel high spout.

CR

**570SF**

Miscelatore monocomando lavello bocca girevole.
Single-lever sink mixer with swivel spout.

CR

**510SF**

Miscelatore monocomando lavello con bocca alta girevole abbattibile. Per sotto-finestra.
Single-lever sink mixer with movable swivel spout. Under window model.

CR

**501SF**

Miscelatore monocomando lavello a parete.
Wall mtg. single-lever sink mixer.

CR



506SFT

**571SFB**

Miscelatore monocomando lavello con canna corta girevole.
Single-lever sink mixer with short swivel spout.

CR

**571SFBC**

Miscelatore monocomando lavello con canna corta girevole.
Single-lever sink mixer with short swivel spout.

CR

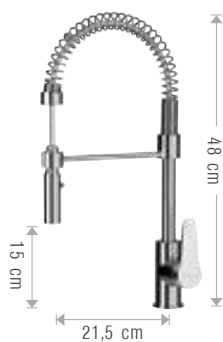
**57DSF**

Miscelatore monocomando lavello a molla con doccetta estraibile dal supporto ed orientabile a due funzioni.
Spring single-lever sink mixer with detachable and adjustable 2 functions handshower.

CR

**505SF**

Miscelatore monocomando lavello a muro, con leva frontale e bocca alta girevole.
Single-lever wall mounted sink mixer with frontal lever and high swivel spout.

CR

TOUCH-ME

**506SFT**

Miscelatore monocomando lavello, con canna alta girevole a "U" dotata di tecnologia "Touch-Me" con leva laterale.
Single-lever sink mixer with high swivel "U" spout equipped with "Touch-Me" system with side lever.

CR

**507SFT**

Miscelatore monocomando lavello, con canna alta quadrata a "U" e girevole dotata di tecnologia "Touch-Me" con leva laterale.
Single-lever sink mixer with squared high swivel "U" spout equipped with "Touch-Me" system with side lever.

CR





SURF ECO 



SURF ECO una collezione di miscelatori dedicata al risparmio idrico ed energetico.

Grazie alla combinazione di diverse tecnologie infatti possibile ridurre gli sprechi senza stravolgere le nostre abitudini quotidiane.

La rubinetteria SURF ECO include di serie la cartuccia ENERGY SAVING e un aeratore con flusso ridotto a 6 litri al minuto.

La rubinetteria pu inoltre essere completata dalle funzioni di risparmio opzionali WATER SAVING DYNAMIC e ANTISCALDING.

Funzioni **STANDARD** nel dettaglio:

- La cartuccia **ENERGY SAVING** evita la richiesta accidentale e involontaria di acqua calda, consentendo così un risparmio energetico. Questa funzione prevede l'apertura solo in acqua fredda quando la leva allineata con la bocca del miscelatore; per la fornitura di acqua calda invece necessario un movimento volontario della leva verso sinistra. STANDARD su tutti i modelli SURF ECO.

L'AERATORE CON FLUSSO RIDOTTO genera una limitazione della portata massima dell'acqua in uscita. STANDARD su tutti i modelli SURF ECO a 6 litri al minuto (disponibile su richiesta anche nelle varianti 8, 4, 3 L/min).

Funzioni **OPZIONALI** nel dettaglio:

- La tecnologia **ANTISCALDING** limita la temperatura massima dell'acqua del singolo rubinetto per un risparmio energetico costante.
- La tecnologia **WATER SAVING DYNAMIC** permette all'utente di scegliere la quantità di acqua realmente necessaria ad ogni operazione. Durante l'apertura, la leva si interrompe prima al 50% del flusso totale e richiede una seconda spinta volontaria per arrivare al 100% dell'erogazione.

Note per le funzioni opzionali:

Per integrare la funzione ANTISCALDING, aggiungere la lettera A alla fine del codice prodotto (393SFLT6C3A).

Per integrare la funzione WATER SAVING DYNAMIC aggiungere la lettera S alla fine del codice prodotto (393SFLT6C3S).

Per integrare sia la funzione ANTISCALDING che la funzione WATER SAVING DYNAMIC aggiungere le lettere SA alla fine del codice prodotto (393SFLT6C3SA).

CARATTERISTICHE TECNICHE:

Dotato di cartuccia ECO a dischi ceramici Ø35 mm. Monocomando.

STANDARD



CARTUCCIA ECO ENERGY SAVING
ENERGY SAVING CARTRIDGE



AERATORE CON LIMITATORE DI PORTATA
AERATOR WITH FLOW LIMITER

OPTIONAL

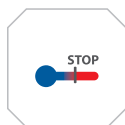

LIMITATORE DI TEMPERATURA
TEMPERATURE LIMITER

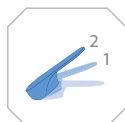

RISPARMIO IDRICO DINAMICO
WATER SAVING DYNAMIC

+ A

+ SA

+ S

SURF ECO is a mixer faucet collection dedicated to water and energy savings. Thanks to the combination of different technologies, it is possible to reduce waste without upsetting our daily habits. SURF ECO mixer taps include as standard features an ENERGY SAVING cartridge and an aerator with reduced passage to 8 litres per minute. The mixer can also be completed with the optional saving features WATER SAVING DYNAMIC and ANTISCALDING.

STANDARD features in detail:

- ENERGY SAVING** cartridge avoids the accidental and unintentional request of hot water, thus allowing energy savings. This feature provides for opening in only cold water when the lever is aligned with the mixer spout; for the supply of hot water a voluntary movement of the lever to the left is instead necessary. STANDARD on all SURF ECO items.
- REDUCED FLOW AERATOR** provides for a limitation of the maximum water flow. STANDARD on all SURF ECO faucets at 6 litres per minute (available on request at 8, 4, 3 L / min).

OPTIONAL features in detail:

- ANTISCALDING** ring technology limits the maximum temperature of the water for a steady energy saving.
- WATER SAVING DYNAMIC** technology allows the user to choose the quantity of water strictly necessary for each operation. During opening, the lever first stops at 50% of the total water flow and requires a second voluntary push to reach 100% of the delivery.

Notes for optional features:

To integrate the ANTISCALDING function, add the letter A at the end of the product code (393SFLT6C3A).

To integrate the WATER SAVING DYNAMIC function add the letter S at the end of the product code (393SFLT6C3S).

To integrate both the ANTISCALDING function and the WATER SAVING DYNAMIC function add the letters SA at the end of the product code (393SFLT6C3SA).

TECHNICAL FEATURES:

Equipped with ceramic disc ECO cartridge Ø35 mm. Single lever.



393SFLT6C3

Miscelatore monocomando lavabo con scarico, con cartuccia per risparmio energetico e limitatore di portata a 6 L/min.
Single-lever basin mixer with pop-up waste, including energy saving cartridge and flow limiter at 6 L/min.

CR



380SFLT6C3

Miscelatore monocomando lavabo senza scarico e senza foro nel corpo, con cartuccia per risparmio energetico e limitatore di portata a 6 L/min.
Single-lever basin mixer without waste and without body hole, including energy saving cartridge and flow limiter at 6 L/min.

CR

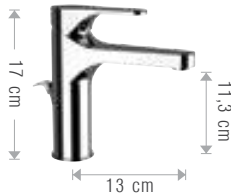

39ASFLT6C3

Miscelatore monocomando lavabo grande, con cartuccia per risparmio energetico e limitatore di portata a 6 L/min.
High single-lever basin mixer, including energy saving cartridge and flow limiter at 6 L/min.

CR



39BSFLT6C3

Miscelatore monocomando lavabo grande senza scarico, con cartuccia per risparmio energetico e limitatore di portata a 6 L/min.
High single-lever basin mixer without waste, including energy saving cartridge and flow limiter at 6 L/min.

CR



398SFLT6C3

Miscelatore monocomando lavabo alto XL senza scarico, con cartuccia per risparmio energetico e limitatore di portata a 6 L/min.
XL high single-lever basin mixer without waste, including energy saving cartridge and flow limiter at 6 L/min.

CR

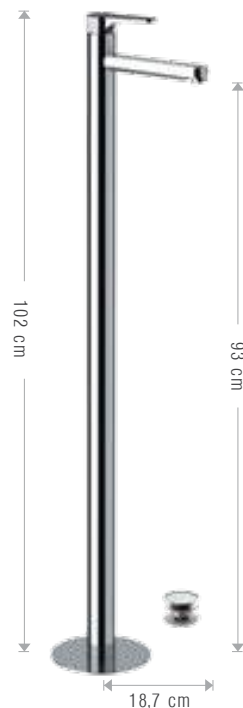

385SFLT6C3

Miscelatore monocomando lavabo da terra con scarico click-clack e troppo pieno, con cartuccia per risparmio energetico e limitatore di portata a 6 L/min.
Single-lever basin mixer for floor-mounting with click-clack waste and overflow, including energy saving cartridge and flow limiter at 6 L/min.

CR

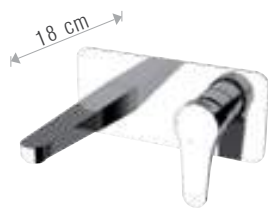

**565SFLT6C3**

Miscelatore monocomando lavabo ad incasso, con cartuccia per risparmio energetico e limitatore di portata a 6 L/min, completo.
Built-in single-lever basin mixer, including energy saving cartridge and flow limiter at 6 L/min, complete.

CR

**565SFLT6C3E**

Solo parte esterna
Only external component

CR

565ATINC

Solo parte incasso
Only built-in components

CR

ARTIC

SURF

SURF ECO

MARTE

HERMÉS

ESSENZA

MAXIMA

EPIC

**493SFLT6C3**

Miscelatore monocomando bidet con scarico, con cartuccia per risparmio energetico e limitatore di portata a 6 L/min.
Single-lever bidet mixer with pop-up waste, including energy saving cartridge and flow limiter at 6 L/min.

CR

**480SFLT6C3**

Miscelatore monocomando bidet senza scarico, con cartuccia per risparmio energetico e limitatore di portata a 6 L/min.
Single-lever bidet mixer without waste, including energy saving cartridge and flow limiter at 6 L/min.

CR

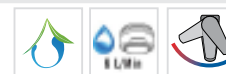
**231SFLT6C3**

Miscelatore monocomando vasca con accessori, bocca 30 cm. Con cartuccia per risparmio energetico e limitatore di portata a 6 L/min.
Wall mtg. single-lever bath mixer with accessories, cm 30 spout. Including energy saving cartridge and flow limiter at 6 L/min.

CR

**185SFWT6C3**

Miscelatore incasso per shut-off comprensivo di doccetta shut-off, supporto doccia, presa acqua, su piastra in ottone cromato e flessibile doccia da 120 cm. Con cartuccia per risparmio energetico e limitatore di portata a 6 L/min.
Built-in shower mixer set including shut-off handshower, connection pipe on flange, completely in c.p. brass and shower flexible 120 cm. Including energy saving cartridge and flow limiter at 6 L/min.

CR



SOFFIONI - SHOWER HEADS

**STA0220LT8**

Soffione a pioggia minimale, in abs cromato Ø 20 cm, con getti in silicone anticalcare, con limitatore di portata a 8 litri/minuto.

C.p. abs shower head, rain jet Ø 20 cm, with anti-limestone silicon jets, with 8 liters/minute flow limiter.

CR

**SQA0120LT8**

Soffione doccia quadrato 20x20 cm in abs lusso, cromato, con getti in silicone autopulenti e anticalcare. Con limitatore di portata a 8 litri/minuto.

Chrome plated square deluxe abs shower head, 20x20 cm with silicon selfcleaning antilimestone jets. With 8 liters/minute flow limiter

CR

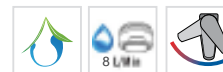
**ST00125LT8**

Soffione doccia ultra piatto in acciaio INOX lucidato a specchio, con limitatore di portata a 8 litri/minuto, Ø25 cm.

Ultra slim stainless steel mirror polished shower head, with 8 liters/minute flow limiter, Ø25 cm.

CR

**SQ00425LT8**

Soffione doccia ultra piatto in acciaio INOX lucidato a specchio, con limitatore di portata a 8 litri/minuto, 25x25 cm.

Ultra slim stainless steel mirror polished shower head, with 8 liters/minute flow limiter, 25x25 cm.

CR

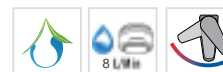

CUCINA - KITCHEN

ARTIC

SURF

SURF ECO

MARTE

HERMÉS

ESSENZA

MAXIMA

EPIC

**506SFLT6C3**

Miscelatore monocomando lavello, bocca girevole alta, con cartuccia per risparmio energetico e limitatore di portata a 6 L/min.

Single-lever sink mixer with swivel high spout, including energy saving cartridge and flow limiter at 6 L/min.

CR

**570SFLT6C3**

Miscelatore monocomando lavello bocca girevole con cartuccia per risparmio energetico e limitatore di portata a 6 L/min.

Single-lever sink mixer with swivel high spout, including energy saving cartridge and flow limiter at 6 L/min.

CR

**57ASFLT6C3**

Bocca fusa girevole.
Casted swivel spout

CR

**510SFLT6C3**

Miscelatore monocomando lavello con bocca alta girevole abbattibile. Per sotto-finestra, con cartuccia per risparmio energetico e limitatore di portata a 6 L/min.

Single-lever sink mixer with movable swivel spout. Under window model. Including energy saving cartridge and flow limiter at 6 L/min

CR

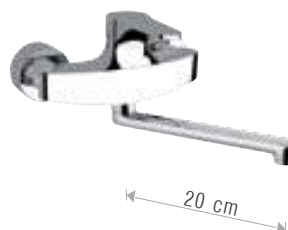
**501SFLT6C3**

Miscelatore monocomando lavello a parete con cartuccia per risparmio energetico e limitatore di portata a 6 L/min.

Wall mtg. single-lever sink mixer including energy saving cartridge and flow limiter at 6 L/min.

CR







MARTE





MARTE è una collezione di miscelatori elegante ed originale per un ambiente bagno di prestigio.

Il rigore della linea squadrata del corpo si fonde armoniosamente con le linee arrotondate della leva e della bocca in un magico accordo geometrico. La serie si caratterizza per il rompigetto a cascata del miscelatore che conferisce all'acqua un'uscita naturale.

La collezione è dotata di cartuccia a dischi ceramici Ø 35 mm.

MARTE is an elegant and original collection of mixer faucets for a prestigious bathroom interior.

The rigor of the square lines of the body pleasantly merges with the rounded lines of the lever and the spout in a magical geometric harmony. The series is characterized by the waterfall jet that gives to water a natural stream.

The collection is equipped with ceramic disc cartridge Ø 35 mm.



393MA
 Miscelatore monocomando lavabo con getto a cascata, con scarico.
 Single-lever basin mixer with waterfall jet, with pop-up waste
 CR



397MA
 Miscelatore monocomando lavabo alto con getto a cascata, senza scarico.
 Single-lever basin mixer high neck with waterfall jet, without pop-up waste.
 CR



237MA
 Batteria bordo vasca 3 fori.
 3 holes bath shower mixer.
 CR



493MA
 Miscelatore monocomando bidet con scarico.
 Single-lever bidet mixer, with pop-up waste.
 CR



230MA
 Miscelatore monocomando vasca con getto a cascata, con accessori e doccia in ABS completamente cromata.
 Wall mtg. single-lever bath mixer with waterfall jet, with accessories and ABS shower completely chromed.
 CR



565MA
 Miscelatore monocomando lavabo ad incasso, lunghezza bocca 18 cm.
 Concealed single-lever basin mixer, length spout 18 cm.
 CR

212MA
 Miscelatore monocomando vasca con getto a cascata, senza accessori.
 Wall mtg. single-lever bath mixer with waterfall jet, without accessories.
 CR

565MAE
 Solo parte esterna
 Only external component
 CR

565ATINC
 Solo parte incasso
 Only built-in components
 CR



570MA

**570MA**

Miscelatore monocomando
lavello bocca girevole.
Single-lever sink mixer with
swivel spout.

CR

ARTIC

SURF

SURF ECO

MARTE

HERMÉS

ESSENZA

MAXIMA

EPIC



179MA
 Miscelatore monocomando
 incasso. Concealed single-lever shower
 mixer.
 CR



173MA
 Miscelatore monocomando
 incasso con deviatore. Concealed single-lever shower
 mixer with diverter.
 CR

179MAE
 Solo parte esterna
 Only external component
 CR

179INC35
 Solo parte incasso
 Only built-in components
 CR

173MAE
 Solo parte esterna
 Only external component
 CR

173INC35
 Solo parte incasso
 Only built-in components
 CR



173MAP2
 Miscelatore monocomando per
 doccia con deviatore a 2 vie su
 unica piastra. Single-lever built-in shower mixer
 with 2 ways diverter on single
 flange.
 CR



173MAP3
 Miscelatore monocomando per
 doccia con deviatore a 3 vie su
 unica piastra. Single-lever built-in shower mixer
 with 3 ways diverter on single
 flange.
 CR

173MAP2E
 Solo parte esterna
 Only external component
 CR

173INC2
 Solo parte incasso
 Only built-in components
 CR

173MAP2E
 Solo parte esterna
 Only external component
 CR

173INC3
 Solo parte incasso
 Only built-in components
 CR

**173MAP4**

Miscelatore monocomando per doccia con deviatore a 4 vie su unica piastra.

Single-lever built-in shower mixer with 4 ways diverter on single flange.

CR

**252MA**

Miscelatore monocomando doccia senza accessori.

Wall mtg. single-lever shower mixer without accessories.

CR

173MAP5

Miscelatore monocomando per doccia con deviatore a 5 vie su unica piastra.

Single-lever built-in shower mixer with 5 ways diverter on single flange.

CR

**17MAP2QB20**

Set doccia composto da: miscelatore a incasso con deviatore a 2 vie su unica piastra (173MAP2); soffione 20x20 cm in ottone cromato (SQB0120); braccio a parete 30 cm in ottone, forma squadrata (BD00430); saliscendi squadrato in ottone; doccetta minimale quadrata a 1 funzione, in ottone (191PF); presa acqua a muro (752PA); flessibile 150 cm.

Shower set including: built-in mixer with 2-way diverter on a single plate (173MAP2); 20x20 cm shower head in c.p. brass (SQB0120); 30 cm brass shower arm, squared shape (BD00430); squared brass sliding rail; 1-function squared hand shower, in brass (191PF); wall connection pipe (752PA); 150 cm flexible hose.

CR

**17BMAP2QB20**

Set doccia composto da: miscelatore a incasso con deviatore a 2 vie su unica piastra (173MAP2); soffione 20x20 cm in ottone cromato (SQB0120); braccio a parete 30 cm in ottone, forma squadrata (BD00430); doccetta minimale quadrata a 1 funzione, in ottone (191PF); presa acqua a muro con supporto snodato (242QD); flessibile 150 cm.

Shower set including: built-in mixer with 2-way diverter on a single plate (173MAP2); 20x20 cm shower head in c.p. brass (SQB0120); 30 cm brass shower arm, squared shape (BD00430); 1-function squared hand shower, in brass (191PF); wall connection pipe with adjustable shower holder (242QD); 150 cm flexible hose.

CR

ARTIC

SURF

SURF ECO

MARTE

HERMÉS

ESSENZA

MAXIMA

EPIC





HERMÉS



HERMÉS è una collezione di miscelatori monocomando per bagno e cucina dalle forme essenziali ed eleganti. La semplicità del design permette di inserire questa collezione sia in ambienti classici che moderni.

La collezione è dotata di cartuccia a dischi ceramici Ø 35 mm.

A series of single-lever mixers with minimalist line for modern bathrooms and kitchens. It combines the essential line and the high practical use.

The collection is equipped with ceramic disc cartridge Ø 35 mm.





393HR

Miscelatore monocomando lavabo con scarico.
Single-lever basin mixer with pop-up waste.

CR

382HR

Miscelatore monocomando lavabo con scarico click-clack.
Single-lever basin mixer with click-clack waste.

CR



397HR

Miscelatore monocomando lavabo alto senza scarico.
High basin mixer without waste.

CR

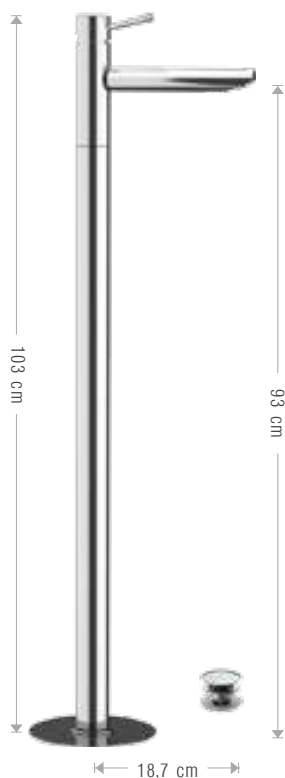

385HR

Miscelatore monocomando lavabo da pavimento con scarico click-clack e troppo pieno.
Single-lever floor mounting mixer with click-clack waste and overflow.

CR



565HR

Miscelatore monocomando lavabo ad incasso con piastra orizzontale.
Built-in single-lever basin mixer with horizontal flange.

CR

565HRE

Solo parte esterna
Only external component

CR

565ESINC

Solo parte incasso
Only built-in components

CR



305HR

Miscelatore monocomando lavabo due fori senza scarico.
Two holes single-lever washbasin mixer without waste.

CR

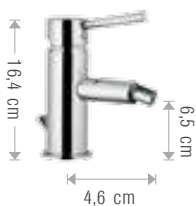
**493HR**

Miscelatore monocomando bidet con scarico.
Single-lever bidet mixer with pop-up waste.

CR

**185HR**

Miscelatore incasso per shut-off comprensivo di doccetta shut-off, supporto e presa acqua, completamente in ottone cromato e flessibile doccia 120 cm.

Built-in shower mixer set including shut-off, shower holder water punch on flange, completely in brass, with handshower support and flexible hose 120 cm.

CR

**402HR**

Miscelatore monocomando per bidet con doccetta.
Single-lever bidet mixer with shower.

CR

**405HR**

Miscelatore monocomando per bidet con deviatore e doccetta.

Single-lever bidet mixer with diverter integrated in the mixer and shower.

CR

**230HR**

Miscelatore monocomando vasca con accessori.
Wall mtg. single-lever bath mixer with accessories.

CR

**212HR**

Miscelatore monocomando vasca senza accessori.

Wall mtg. single-lever bath mixer without accessories.

CR

**237HR**

Batteria bordo vasca 3 fori.
3 holes bath shower mixer deck mtg.

CR

**175HR**

Miscelatore monocomando per vasca da incasso su piastra rettangolare. Lunghezza bocca: 18 cm.

Built-in single-lever bath mixer with rectangular wall-flange. Length spout 18 cm.

CR

ARTIC

SURF

SURF ECO

MARTE

HERMÉS

ESSENZA

MAXIMA

EPIC



182HR

Miscelatore monocomando incasso con piastra lusso. Concealed single-lever shower mixer, with luxur flange.

CR



173HR

Miscelatore monocomando incasso con deviatore, piastra lusso. Concealed single-lever shower mixer with diverter, luxur flange.

CR

182HRE

Solo parte esterna
Only external component

CR

179INC35

Solo parte incasso
Only built-in components

CR

173HRE

Solo parte esterna
Only external component

CR

173INC35

Solo parte incasso
Only built-in components

CR



173HRP2

Miscelatore monocomando per doccia con deviatore a 2 vie su unica piastra. Single-lever built-in shower mixer with 2 ways diverter on single flange.

CR



173HRP3

Miscelatore monocomando per doccia con deviatore a 3 vie su unica piastra. Single-lever built-in shower mixer with 3 ways diverter on single flange.

CR

173HRP2E

Solo parte esterna
Only external component

CR

173INCP2

Solo parte incasso
Only built-in components

CR

173HRP2E

Solo parte esterna
Only external component

CR

173INCP3

Solo parte incasso
Only built-in components

CR



179HR

Miscelatore monocomando incasso. Concealed single-lever shower mixer.

CR



174HR

Miscelatore monocomando incasso con deviatore. Concealed single-lever shower mixer with diverter.

CR

179HRE

Solo parte esterna
Only external component

CR

179INC35

Solo parte incasso
Only built-in components

CR

174HRE

Solo parte esterna
Only external component

CR

173INC35

Solo parte incasso
Only built-in components

CR

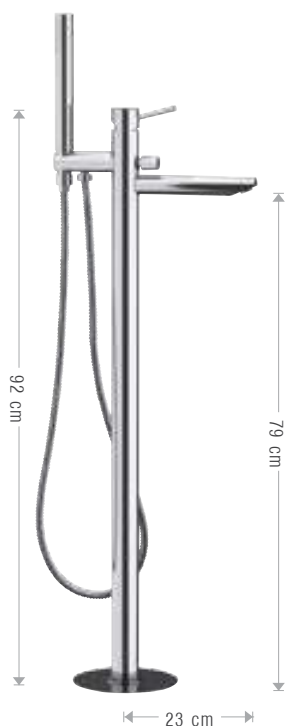

21AHR

Miscelatore vasca da pavimento con deviatore e Set doccia, senza scarico.
Single-lever bath mixer floor mounting with diverter and Shower set.

CR



760HR

Kit composto da: asta saliscendi cromata con doccetta a 1 funzione in abs cromato (191HR); flessibile 150 cm.
Kit including: c.p. sliding rail with 1-function hand shower in c.p. abs (191HR); 150 cm flexible hose.

CR



252HR

Miscelatore monocomando doccia senza accessori.
Wall mtg. single-lever shower mixer without accessories.

CR



Set doccia composto da: miscelatore a incasso con deviatore (174HR); soffione ultrapiatto, in acciaio INOX lucidato (ST00120); braccio a parete in ottone 30 cm (BD00330); doccetta a 1 funzione in abs cromato (191HR); presa acqua a muro con supporto fisso (242MN); flessibile 150 cm.

Shower set including: built-in mixer with diverter (174HR); ultra-flat shower head in polished stainless steel (ST00120); 30 cm brass wall arm (BD00330); 1-function hand shower in c.p. abs (191HR); wall connection pipe with shower holder (242MN); 150 cm flexible hose.



Set doccia composto da: miscelatore a incasso con deviatore (174HR); soffione ultrapiatto, in acciaio INOX lucidato (ST00120); braccio a parete in ottone 30 cm (BD00330); asta saliscendi cromata; doccetta a 1 funzione in abs cromato (191HR); presa acqua a muro (752N0); flessibile 150 cm.

Shower set including: built-in mixer with diverter (174HR); ultra-flat shower head in polished stainless steel (ST00120); 30 cm brass wall arm (BD00330); c.p. sliding rail; 1-function hand shower in c.p. abs (191HR); wall connection pipe (752N0); 150 cm flexible hose.

17BHRTX20

con soffione doccia Ø20 cm, con braccio doccia 30 cm
with shower head Ø20 cm with arm 30 cm;

17BHRTX25

con soffione doccia Ø25 cm, con braccio doccia 30 cm
with shower head Ø25 cm with arm 30 cm;

17BHRTX30

con soffione doccia Ø30 cm, con braccio doccia 30 cm
with shower head Ø30 cm with arm 30 cm;

17AHRTX20

con soffione doccia Ø20 cm, con braccio doccia 30 cm
with shower head Ø20 cm with arm 30 cm;

17AHRTX25

con soffione doccia Ø25 cm, con braccio doccia 30 cm
with shower head Ø25 cm with arm 30 cm;

17AHRTX30

con soffione doccia Ø30 cm, con braccio doccia 30 cm
with shower head Ø30 cm with arm 30 cm;

CUCINA - KITCHEN

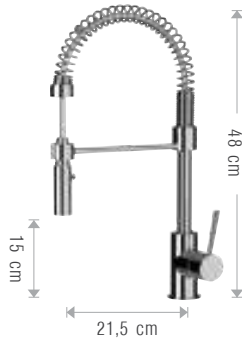
**570HR**

Miscelatore monocomando lavello a molla con doccetta estraibile a 2 funzioni.
Single-lever sink mixer with spring spout and 2 functions pull-out handshower.

CR

**577HR**

Miscelatore monocomando lavello con molla estetica.
Single-lever sink mixer with aesthetic spring spout.

CR

**506HR**

Miscelatore monocomando lavello con bocca alta girevole.
Single-lever sink mixer with high swivel spout.

CR

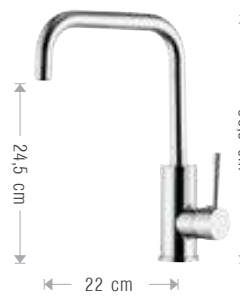
**507HR**

Miscelatore monocomando lavello.
Single-lever sink mixer.

CR



ARTIC

SURF

SURF ECO

MARTE

HERMÉS

ESSENZA

MAXIMA

EPIC

57DHR





ESSENZA



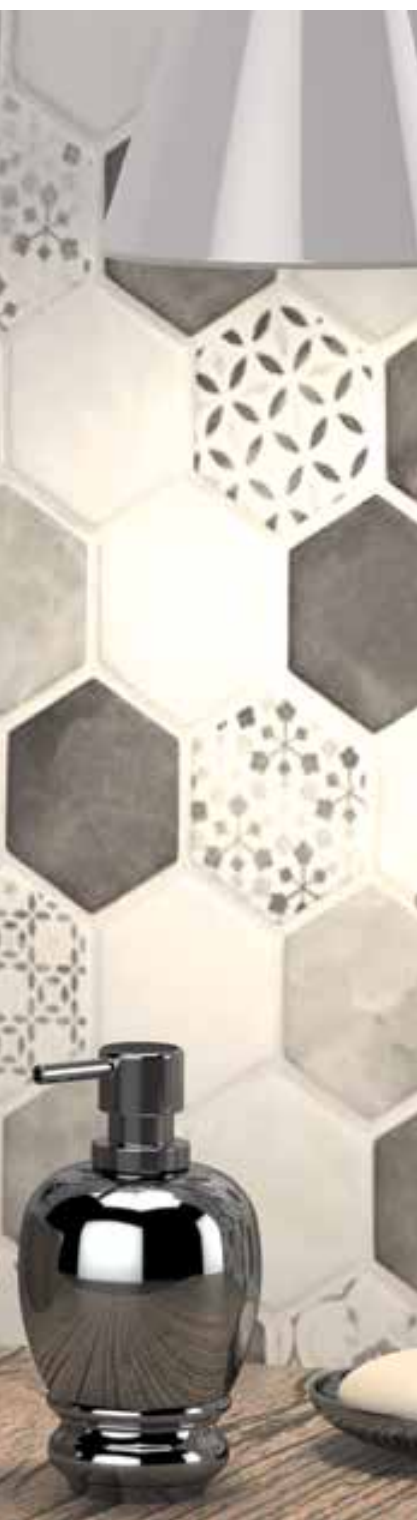

Nella collezione ESSENZA, il corpo del miscelatore che si proietta verso l'alto, definisce uno spazio funzionale più ampio che dona comfort e praticità di utilizzo. L'innovazione tecnologica della parte interna ed un sistema di fissaggio pratico e sicuro semplificano i criteri di installazione e manutenzione di questo prodotto.

Pur distinguendosi per l'alta qualità ed per un design ricercato, la collezione ESSENZA viene posizionata in una fascia di prezzo competitiva grazie alle innovative tecniche di produzione.

La collezione è dotata di cartuccia a dischi ceramici Ø 35 mm.

In the ESSENZA collection, the upward body of the mixer defines a larger functional space that provides comfort and ease of use.

The technological innovation of the internal parts and a practical and safe fixing system simplify the installation and maintenance criteria of this product.

Despite the high quality and the refined design, the ESSENZA collection is positioned in a competitive price range thanks to innovative production techniques.

The collection is equipped with ceramic disc cartridge Ø 35 mm.



A parità di flusso dell'acqua, una maggiore aerazione consente un risparmio idrico fino al 70%.
The same water flow mixed with air gets a water saving up to 70%.

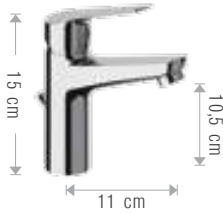

393ES

Miscelatore monocomando lavabo con scarico.
Single-lever basin mixer with pop-up waste.

CR

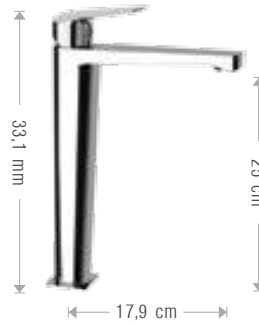

398ES

Miscelatore monocomando lavabo alto senza scarico.
High basin mixer without waste.

CR



565ES

Miscelatore monocomando lavabo ad incasso, completo.
Concealed single-lever basin mixer, complete.

CR

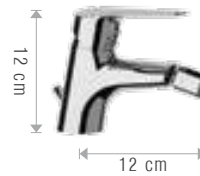

493ES

Miscelatore monocomando bidet con scarico.
Single-lever bidet mixer with pop-up waste.

CR



565ESE

Solo parte esterna
Only external component

CR

565ESINC

Solo parte incasso
Only built-in components

CR



230ES

Miscelatore monocomando vasca con accessori.
Wall mtg. single-lever bath mixer with accessories.

CR



212ES

Miscelatore monocomando vasca senza accessori.
Wall mtg. single-lever bath mixer without accessories.

CR



179ES

Miscelatore monocomando incasso, completo.
Concealed single-lever shower mixer, complete.

CR



173ES

Miscelatore monocomando incasso con deviatore, completo.
Concealed single-lever shower mixer with diverter, complete.

CR

179ESE

Solo parte esterna
Only external component

CR

179INC35

Solo parte incasso
Only built-in components

CR

173ESE

Solo parte esterna
Only external component

CR

173INC35

Solo parte incasso
Only built-in components

CR



173ESP2

Miscelatore monocomando per doccia con deviatore a 2 vie su unica piastra, completo.
Single-lever built-in shower mixer with 2 ways diverter on single flange, complete.

CR



173ESP3

Miscelatore monocomando per doccia con deviatore a 3 vie su unica piastra, completo.
Single-lever built-in shower mixer with 3 ways diverter on single flange, complete.

CR

173ESP2E

Solo parte esterna
Only external component

CR

173INCP2

Solo parte incasso
Only built-in components

CR

173ESP2E

Solo parte esterna
Only external component

CR

173INCP3

Solo parte incasso
Only built-in components

CR



252ES

Miscelatore monocomando doccia senza accessori.
Wall mtg. shower single-lever mixer without accessories.

CR



237ES

Batteria bordo vasca 3 fori.
3 holes bath shower mixer deck mtg.

CR



Colonna doccia a 3 vie composta da: miscelatore vasca/doccia con deviatore integrato nella bocca; soffione in ABS cromato (STA0120); colonna telescopica in ottone con altezza regolabile; doccetta a 4 funzioni con pulsante per il cambio dei getti, in abs cromato (191MP); flessibile 150 cm.

3-way shower column including: bath/shower mixer with diverter integrated in the spout; shower head in c.p. abs (STA0120); height-adjustable telescopic brass column; 4-function hand shower with button for changing the jets, abs, anti-limescale (191MP); 150 cm flexible hose.

260ESATA20

con soffione doccia Ø20 cm.
with shower head Ø20 cm.

260ESATA25

con soffione doccia Ø25 cm.
with shower head Ø25 cm.

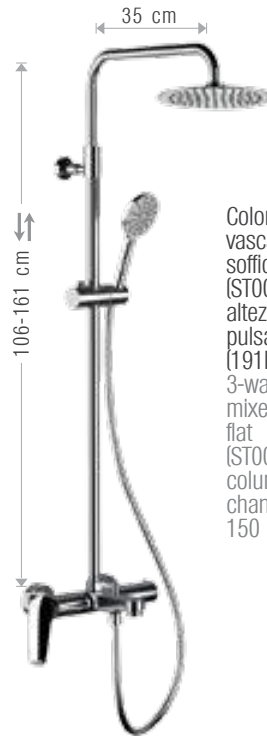

Colonna doccia a 3 vie composta da: miscelatore vasca/doccia con deviatore integrato nella bocca; soffione ultrapiatto, in acciaio INOX lucidato (ST00120); colonna telescopica in ottone con altezza regolabile; doccetta a 4 funzioni con pulsante per il cambio dei getti, in abs cromato (191MP); flessibile 150 cm.

3-way shower column including: bath/shower mixer with diverter integrated in the spout; ultra-flat shower head in polished stainless steel (ST00120); height-adjustable telescopic brass column; 4-function hand shower with button for changing the jets, abs, anti-limescale (191MP); 150 cm flexible hose.

260ESATX20

con soffione doccia Ø20 cm.
with shower head Ø20 cm.

260ESATX25

con soffione doccia Ø25 cm.
with shower head Ø25 cm.

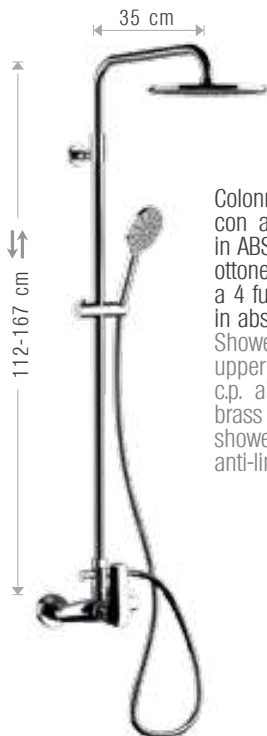

Colonna doccia composta da: miscelatore esterno con attacco superiore da 3/4" (259ES); soffione in ABS cromato (STA0120); colonna telescopica in ottone con altezza regolabile, deviatore; doccetta a 4 funzioni con pulsante per il cambio dei getti, in abs cromato (191MP); flessibile 150 cm.

Shower column including: exposed mixer with upper 3/4" connection (259ES); shower head in c.p. abs (STA0120); height-adjustable telescopic brass column with diverter; 4-function hand shower with button for changing the jets, abs, anti-limescale (191MP); 150 cm flexible hose.

259ESATA20

con soffione doccia Ø20 cm.
with shower head Ø20 cm.

259ESATA25

con soffione doccia Ø25 cm.
with shower head Ø25 cm.

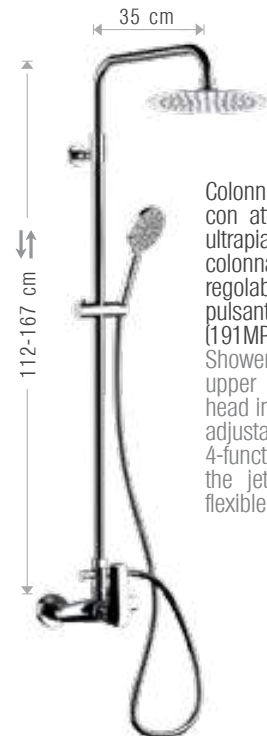

Colonna doccia composta da: miscelatore esterno con attacco superiore da 3/4" (259ES); soffione ultrapiatto, in acciaio INOX lucidato (ST00120); colonna telescopica in ottone con altezza regolabile, deviatore; doccetta a 4 funzioni con pulsante per il cambio dei getti, in abs cromato (191MP); flessibile 150 cm.

Shower column including: exposed mixer with upper 3/4" connection (259ES); ultra-flat shower head in polished stainless steel (ST00120); height-adjustable telescopic brass column with diverter; 4-function hand shower with button for changing the jets, abs, anti-limescale (191MP); 150 cm flexible hose.

259ESATX20

con soffione doccia Ø20 cm.
with shower head Ø20 cm.

259ESATX25

con soffione doccia Ø25 cm.
with shower head Ø25 cm.



Set doccia composto da: miscelatore a incasso con deviatore (173ES); soffione in ABS cromato (STA0120); braccio a parete in ottone 30 cm (BDL0530); doccetta a 4 funzioni con pulsante per il cambio dei getti, in abs cromato (191MP); presa acqua a muro con supporto fisso (242MN); flessibile 150 cm.
Shower set including: built-in mixer with diverter (173ES); shower head in c.p. abs (STA0120); 30 cm brass wall arm (BDL0530); 4-function hand shower with button for changing the jets, in abs cromato (191MP); wall connection pipe with shower holder (242MN); 150 cm flexible hose.

17BESTA20

con soffione doccia Ø20 cm.
with shower head Ø20 cm.

17BESTA25

con soffione doccia Ø25 cm.
with shower head Ø25 cm.



Set doccia composto da: miscelatore a incasso con deviatore (173ES); soffione in ABS cromato (STA0120); braccio a parete in ottone 30 cm (BDL0530); asta saliscendi cromata; doccetta a 4 funzioni con pulsante per il cambio dei getti, in abs cromato (191MP) presa acqua a muro (752NO); flessibile 150 cm.
Shower set including: built-in mixer with diverter (173ES); shower head in c.p. abs (STA0120); 30 cm brass wall arm (BDL0530); c.p. sliding rail; 4-function hand shower with button for changing the jets, abs, anti-limescale (191MP); wall connection pipe (752NO); 150 cm flexible hose.

17AESTA20

con soffione doccia Ø20 cm.
with shower head Ø20 cm.

17AESTA25

con soffione doccia Ø25 cm.
with shower head Ø25 cm.

CUCINA - KITCHEN



506ES

Miscelatore monocomando lavello con bocca girevole.
Single-lever sink mixer with swivel spout.

CR



50AES

Miscelatore monocomando lavello con canna alta girevole.
Single-lever sink mixer with high swivel spout.

CR



570ES

Miscelatore monocomando lavello con bocca girevole.
Single-lever sink mixer with swivel spout.

CR



505ES

Gruppo lavello a parete con bocca girevole.
Wall mtg. sink mixer with swivel spout.

CR



La collezione è dotata di cartuccia a dischi ceramici Ø 40 mm.

The collection is equipped with ceramic disc cartridge Ø 40 mm.



ARTIC

SURF

SURF ECO

MARTE

HERMÉS

ESSENZA

MAXIMA

EPIC

MAXIMA



A parità di flusso dell'acqua, una maggiore aerazione consente un risparmio idrico fino al 70%.
The same water flow mixed with air gets a water saving up to 70%.

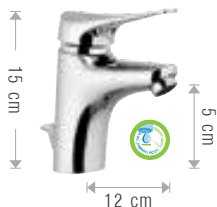

393MM

Miscelatore monocomando lavabo con scarico.
Single-lever basin mixer with pop-up waste.

CR



382MM

Miscelatore monocomando lavabo con scarico click-clack.
Single-lever basin mixer with click-clack waste.

CR



493MM

Miscelatore monocomando bidet con scarico.
Single-lever bidet mixer with pop-up waste.

CR



237MM

Batteria bordo vasca 3 fori.
3 holes bath shower mixer.

CR



230MM

Miscelatore monocomando vasca con accessori.
Wall mtg. single-lever bath mixer with accessories.

CR



212MM

Miscelatore monocomando vasca senza accessori.
Wall mtg. single-lever bath mixer without accessories.

CR



179MM

Miscelatore monocomando incasso.
Concealed single-lever shower mixer.

CR



173MM

Miscelatore monocomando incasso con deviatore.
Concealed single-lever shower mixer with diverter.

CR

CUCINA - KITCHEN



508MM

Miscelatore monocomando lavello bocca girevole.
Single-lever sink mixer with swivel spout.

CR

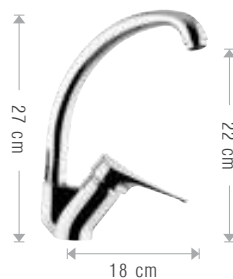

570MM

Miscelatore monocomando lavello bocca girevole.
Single-lever sink mixer with swivel spout.

CR



511MM

Miscelatore monocomando lavello bocca girevole doccia estraibile 2 getti.
Single-lever sink mixer with swivel spout and 2 jets pull-out shower.

CR



512MM

Miscelatore monocomando lavello bocca girevole con deviatore per lavastoviglie.
Single-lever sink mixer with swivel spout dish-washing machine diverter.

CR



511MM

ARTIC

SURF

SURF ECO

MARTE

HERMÉS

ESSENZA

MAXIMA

EPIC



La collezione è dotata di cartuccia a dischi ceramici Ø 40 mm.

The collection is equipped with ceramic disc cartridge Ø 40 mm.



EPIC

LEVE DISPONIBILI

La leva di miscelazione nella collezione EPIC è disponibile in 4 diversi modelli di design.
Indicare il codice di preferenza al momento dell'ordine.

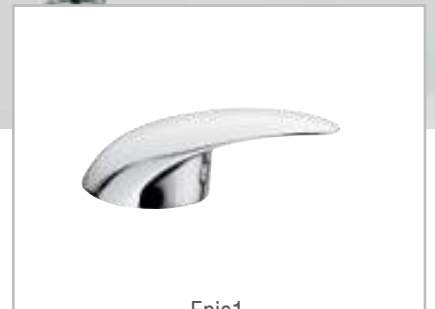

Epic1
.E1

EPIC

LEVER OPTIONS

The mixing lever in the EPIC collection is available with 4 different design options. Refer to your preference code when ordering.

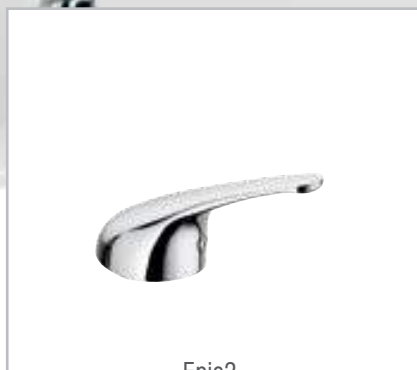

Epic2
.E2



Epic3
.E3



Epic5
.E5



393E2

Miscelatore monocomando lavabo con scarico.
Single-lever basin mixer with pop-up waste.

CR



39XE2

Miscelatore monocomando lavabo, bocca lunga e scarico.
Single-lever basin mixer, with long spout and pop-up waste.

CR

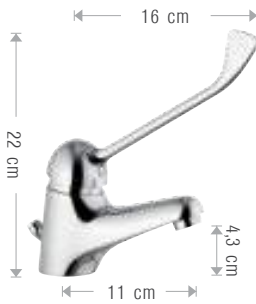

389E9

Miscelatore monocomando lavabo con leva clinica e scarico.
Single-lever basin mixer with clinical lever and pop-up waste.

CR



39XE9

Miscelatore monocomando lavabo con leva clinica, bocca lunga e scarico.
Single-lever basin mixer with clinical lever, long spout and pop-up waste.

CR



493E2

Miscelatore monocomando bidet con scarico.
Single-lever bidet mixer with popup waste.

CR



306E2

Mixer per parrucchiere completo, con doccia estraibile.
Barber mixer complete, with pull-out shower.

CR



402E2

Miscelatore monocomando bidet con doccia.
Single-lever bidet mixer with shower.

CR



489E9

Miscelatore monocomando bidet con leva clinica e scarico.
Single-lever bidet mixer with clinical lever and pop-up waste.

CR

**230E2**

Miscelatore monocomando vasca con accessori.
Wall mtg. single-lever bath mixer with accessories.

CR

212E2

Miscelatore monocomando vasca senza accessori.
Wall mtg. single-lever bath mixer without accessories.

CR

**231E2**

Miscelatore monocomando vasca con accessori.
Wall mtg. single-lever bath mixer with accessories.

CR

**239E2**

Batteria bordo vasca 3 fori con bocca a cascata.
3 holes bath shower mixer deck mtg. with waterfall spout.

CR

**237E2**

Batteria bordo vasca 3 fori.
3 holes bath shower mixer deck mtg.

CR

**252E2**

Miscelatore monocomando doccia senza accessori.
Wall mtg. single-lever shower mixer without accessories.

CR

**252E9**

Miscelatore monocomando doccia con leva clinica, senza accessori.
Wall mtg. single-lever shower mixer with clinical lever, without accessories.

CR

**179E2**

Miscelatore monocomando incasso.
Concealed single-lever shower mixer.

CR

**173E2**

Miscelatore monocomando incasso con deviatore.
Concealed single-lever shower mixer with diverter.

CR

**254E2**

Miscelatore monocomando doccia con leva frontale senza accessori.
Wall mtg. single-lever shower mixer with frontal lever, without accessories.

CR

ARTIC

SURF

SURF ECO

MARTE

HERMÉS

ESSENZA

MAXIMA

EPIC

CUCINA - KITCHEN



508E2
Miscelatore monocomando lavello bocca girevole.
Single-lever sink mixer with swivel spout.

CR



589E9
Miscelatore monocomando lavello con bocca girevole e leva clinica.
Single-lever sink mixer with swivel spout and clinic lever.

CR



511E2
Miscelatore monocomando lavello bocca girevole doccia estraibile 2 getti.
Single-lever sink mixer with swivel spout and 2 jets pull-out shower.

CR



511E9
Miscelatore monocomando lavello con leva clinica, bocca girevole e doccia estraibile 2 getti.
Single-lever sink mixer with swivel spout and 2 jets pull-out shower.

CR



512E2
Miscelatore monocomando lavello bocca girevole con deviatore per lavastoviglie.
Single-lever sink mixer with swivel spout dish-washing machine diverter.

CR



D72E2
Miscelatore lavello a 3 vie d'ingresso con bocca girevole, selezione acqua potabile tramite la leva, 2 aeratori in uscita.
3 ways inlet single-lever sink mixer, with swivel spout, selection for drinking water directly from the lever, 2 exits aerators.

CR



570E2
Miscelatore monocomando lavello con bocca fusa.
Single-lever sink mixer with casted spout.

CR

57AE2
Miscelatore monocomando lavello con bocca alta girevole.
Single-lever sink mixer with high swivel spout.

CR



57AE9
Miscelatore monocomando lavello con bocca alta girevole e leva clinica.
Single-lever sink mixer with high swivel spout and clinical lever.

CR



506E2
 Miscelatore monocomando lavello bocca girevole.
 Single-lever sink mixer with swivel spout.
 CR



571E2
 Miscelatore monocomando lavello bocca girevole.
 Single-lever sink mixer with swivel spout.
 CR



510E2
 Miscelatore monocomando lavello, bocca alta tipo lusso, modello sottofinestra.
 Single-lever sink mixer, with high spout movable and orientable, luxury under window type.
 CR



505E2
 Miscelatore monocomando lavello a muro, con leva frontale e bocca alta girevole.
 Single-lever wall mounted sink mixer with frontal lever and high movable spout.
 CR



501E2
 Miscelatore monocomando lavello a parete bocca girevole.
 Wall mtg. single-lever sink mixer with swivel spout.
 CR



580E9
 Miscelatore monocomando lavello a parete con leva clinica e bocca girevole.
 Wall mtg. single-lever sink mixer with clinic lever and movable spout.
 CR

ARTIC

SURF

SURF ECO

MARTE

HERMÉS

ESSENZA

MAXIMA

EPIC





TRADITION





TRADITION è una collezione di rubinetteria bi-comando che richiama la romantica raffinatezza di un'epoca antica e di un'eleganza intramontabile.

Ogni particolare è studiato nei minimi particolari per essere in totale armonia con uno stile di arredo classico e vintage.

La collezione è dotata di vitoni a dischi ceramici da 1/2 giro.

TRADITION is a collection of two-control taps that recalls the romantic taste of an ancient era and a timeless elegance.

Every detail is studied in detail to be in total harmony with a classic and vintage interior style.

The collection is equipped with 1/2 turn ceramic disc head valves.



395TR
 Monoforo lavabo con scarico.
 Single hole basin set with pop-up waste.

CR



392TR
 Monoforo lavabo con scarico.
 Single hole basin set with pop-up waste.

CR



396TR
 Monoforo lavabo senza scarico.
 Single hole basin set without waste.

CR



390TR
 Monoforo lavabo senza scarico.
 Single hole basin set without waste.

CR



337TRB
 Monoforo lavabo con scarico.
 Single hole basin set with pop-up waste.

CR



345TR
 Monoforo lavabo senza scarico.
 Single hole basin set without waste.

CR



307TR
 Batteria lavabo 3 fori con scarico.
 3 holes basin set with pop-up waste.

CR



540TR
 Rubinetto a colonna da 1/2".
 1/2" basin pillar tap.

CR



100TR
 Rubinetto arresto da 1/2".
 1/2" concealed valve.

CR



300TR

Batteria lavabo 3 fori con scarico.
3 holes basin set with pop-up waste.

CR



422TR

Batteria bidet 3 fori con scarico.
3 holes bidet set with pop-up waste.

CR



495TR

Monoforo bidet con scarico.
Single hole bidet set with pop-up waste.

CR



353TR

Rubinetto collo cigno.
Basin pillar tap.

CR



215TR

Gruppo esterno vasca con doccetta.
Wall mtg. bathtub set with handshower.

CR



223TR

Gruppo esterno vasca con accessori.
Wall mtg. bathtub set with accessories.

CR

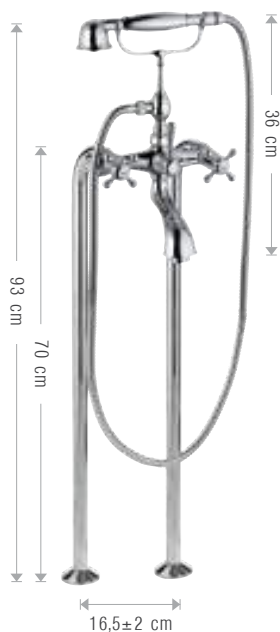

23ATR

Gruppo esterno vasca con doccetta, su colonne da pavimento.
Wall mtg. bathtub set with handshower, on floor columns.

CR

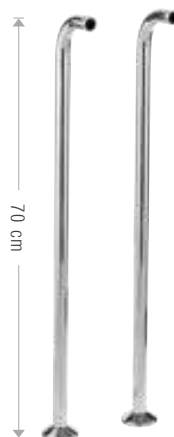

87ATR

Colonne da pavimento 70 cm.
Floor columns, 70 cm.

CR



A44CD

Colonna doccia composta da: gruppo doccia a muro bicomando; soffione a campana in ottone Ø 20 cm; colonna con deviatore, flessibile 150 cm; doccetta a 1 funzione, in ottone (191TS).

Shower column including: 2-handle exposed shower system; brass bell shaped shower head Ø 20 cm; column with diverter, 150 cm flexible hose; 1-function brass hand shower (191TS).

CR



A43CD

Colonna doccia composta da: miscelatore termostatico esterno con attacco superiore (271); soffione a campana in ottone Ø 20 cm; colonna con deviatore; doccetta a 1 funzione, in ottone (191TS); flessibile 150 cm.

Shower column including: exposed thermostatic mixer with upper connection (271); Ø 20 cm brass bell shower head; column with diverter; 1-function brass hand shower (191TS); 150 cm flexible hose.

CR



237TR

Batteria bordo vasca 4 fori. 4 holes bath shower mixer.

CR



760TR

Saliscendi con asta tonda e doccetta in ottone cromato. Chrome plated brass sliding rail and shower.

CR



255TR

Gruppo esterno doccia senza accessori. Shower set without accessories.

CR



336TR

Monoforo lavello bocca girevole. Single hole sink set with swivel spout.

CR



502TR

Gruppo lavello a parete con bocca girevole. Wall mgt. sink set with swivel spout.

CR



337TR



337TR

Monoforo lavello bocca girevole.
Single hole sink set with swivel spout.

CR



322TR

Monoforo lavello bocca girevole.
Single hole sink set with swivel spout.

CR



La collezione è dotata
di vitoni a dischi ceramici

The collection is equipped
with ceramic disc head valves.



MEISSA

MEISSA

LEVE DISPONIBILI

Le maniglie nella collezione MEISSA sono disponibili in 3 diversi modelli di design: Meissa (.MS), Mira (.MI), Mimosa (.MO). Indicare il codice di preferenza al momento dell'ordine.

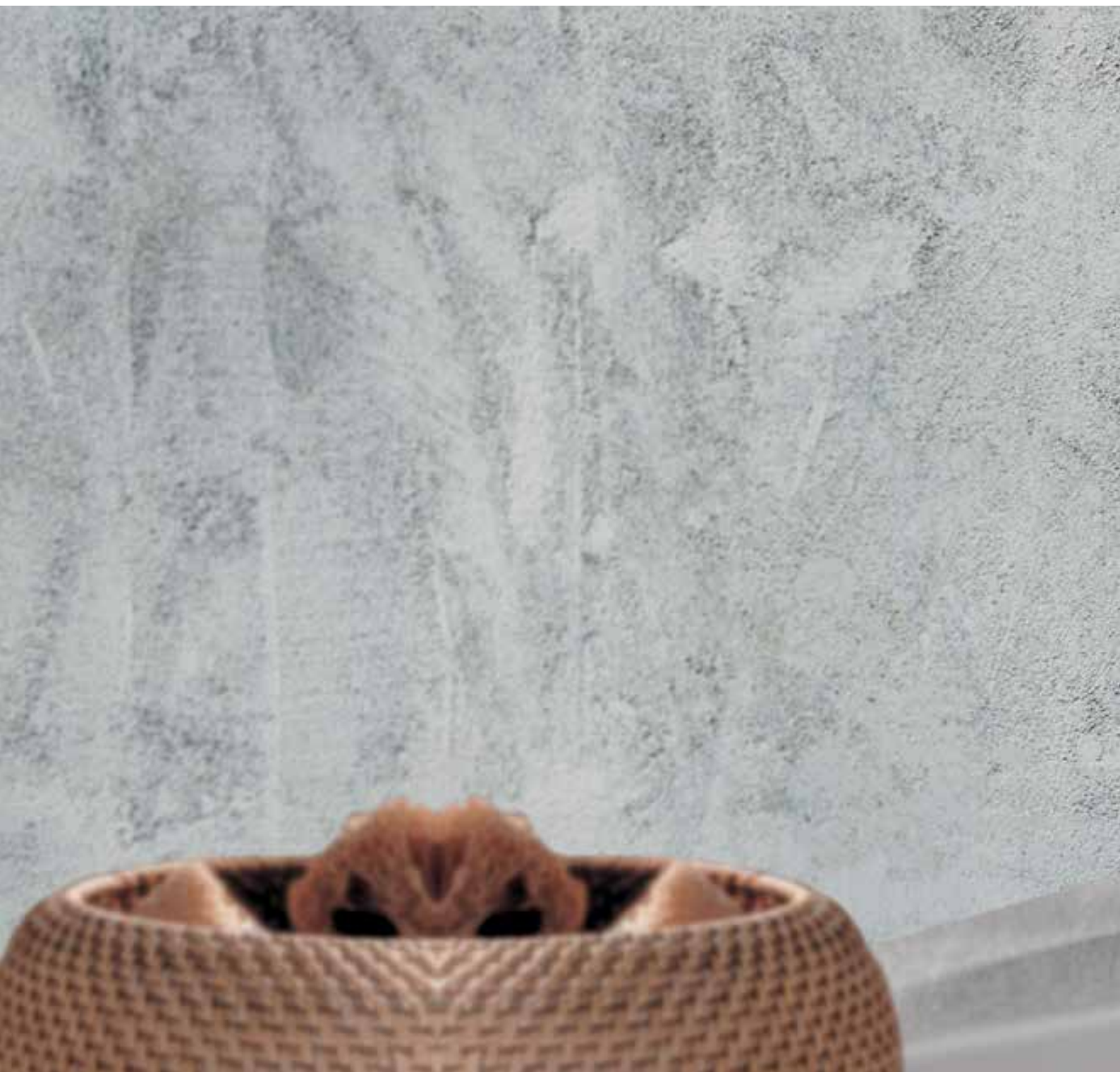

MEISSA

HANDLE OPTIONS

The handles in the MEISSA collection are available with 3 different design models: Meissa (.MS), Mira (.MI), Mimosa (.MO). Refer to your preference code when ordering.

TRADITION

MEISSA

DOMINO

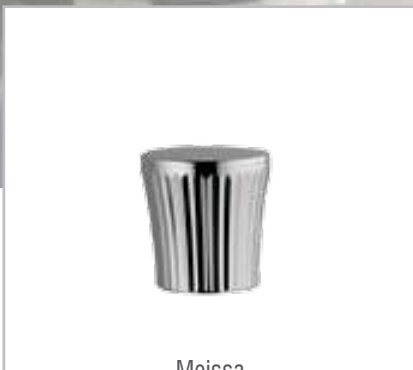

Meissa
.MS



Mira
.MI



Mimosa
.MO



392MS
 Monoforo lavabo con scarico.
 Single hole basin set with pop-up waste.
 CR



390MS
 Monoforo lavabo senza scarico.
 Single hole basin set without waste.
 CR



334MS
 Monoforo lavabo con scarico.
 Single hole basin set with pop-up waste.
 CR

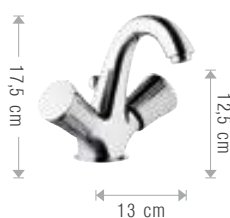

395MS
 Monoforo lavabo con scarico.
 Single hole basin set with pop-up waste.
 CR



301MS
 Batteria lavabo 3 fori con scarico.
 3 holes basin set with pop-up waste.
 CR



311MS
 Batteria lavabo 3 fori senza scarico.
 3 holes basin set without waste.
 CR



303MS
 Batteria lavabo 3 fori con scarico.
 3 holes basin set with pop-up waste.
 CR



313MS
 Batteria lavabo 3 fori senza scarico.
 3 holes basin set without waste.
 CR



348MS

Gruppo lavabo a ponte senza scarico.
Basin bridge set without waste.

CR



422MS

Batteria bidet 3 fori con scarico.
3 holes bidet set with pop-up waste.

CR



432MS

Rubinetto bidet (coppia).
Bidet faucet (pair).

CR



492MS

Monoforo bidet con scarico.
Single hole bidet set with pop-up waste.

CR



403MS

Bordo bidet 3 fori con doccia e deviatore.
3 holes bidet set mixer with shower and diverter.

CR



215MS

Gruppo esterno vasca con doccia.
Wall mtg. bathtub set with handshower.

CR



223MS

Gruppo esterno vasca con accessori.
Wall mtg. bathtub set with accessories.

CR



231MS

Gruppo esterno vasca con accessori e tubo 400 mm.
Wall mtg. bathtub set with accessories and pipe 400 mm.

CR



255MS

Gruppo esterno doccia senza accessori.
Shower set without accessories.

CR

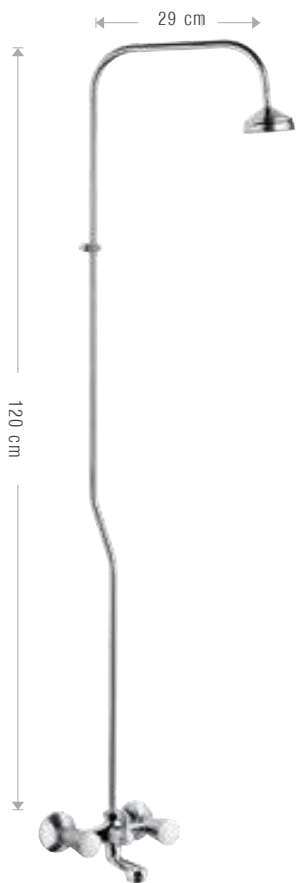

220MS
Gruppo esterno vasca con colonna doccia.
Wall mtg. bathtub set with shower column.

CR

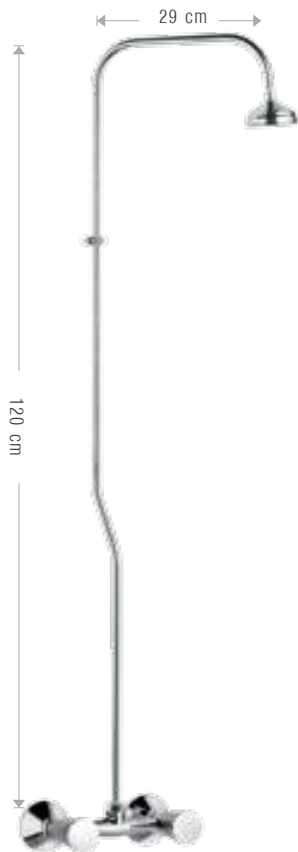

25CMS
Gruppo esterno doccia con colonna doccia.
Wall mtg. shower set with shower column.

CR

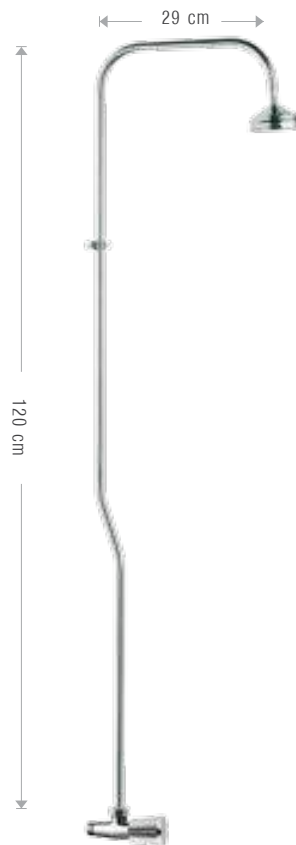

539MS
Gruppo doccia monoacqua con colonna doccia.
Wall mtg. single water shower set with shower column.

CR



112MS
Rubinetto arresto da 1/2" a squadra.
1/2" square concealed valve.

CR



353MS
Rubinetto collo cigno.
Basin pillar tap.

CR



330MS
Monoforo lavello bocca girevole.
Single hole sink set with swivel spout.

CR



502MS
Gruppo lavello a parete con bocca girevole.
Wall mgt. sink set with swivel spout.

CR



505MS
Gruppo lavello a parete con bocca girevole.
Wall mgt. sink set with swivel spout.
CR



514MS
Gruppo lavello a parete con bocca girevole e attacco lavatrice.
Wall mtg. sink set with swivel spout and washing machine outlet.
CR



504MS
Gruppo lavello a parete con bocca girevole.
Wall mgt. sink set with swivel spout.
CR



522MS
Rubinetto prolungato da 1/2".
1/2" Extended tap.
CR



524MS
Rubinetto da 1/2" con attacco lavatrice.
1/2" Sink tap washing machine outlet.
CR



525MS
Rubinetto prolungato da 1/2", 15,5 cm.
1/2" extended tap, 15,5 cm.
CR



533MS
Rubinetto a snodo da 1/2".
Joint faucet 1/2".
CR



540MS
Rubinetto a colonna da 1/2".
1/2" basin pillar tap.
CR



536MS
Rubinetto a squadra.
Angular tap.
CR



102MS
Rubinetto arresto da 1/2".
1/2" concealed valve.
CR



La collezione è dotata di
vitoni tradizionali a lunga durata

The collection is equipped with
traditional head valves, long lasting type.



DOMINO



3921D

Monoforo lavabo con scarico.
Single hole basin set with pop-up waste.

CR



3901D

Monoforo lavabo senza scarico.
Single hole basin set without waste.

CR



3341D

Monoforo lavabo con scarico.
Single hole basin set with pop-up waste.

CR



3951D

Monoforo lavabo con scarico.
Single hole basin set with pop-up waste.

CR



3011D

Batteria lavabo 3 fori con scarico.
3 holes basin set with pop-up waste.

CR



3111D

Batteria lavabo 3 fori senza scarico.
3 holes basin set without pop-up.

CR



3031D

Batteria lavabo 3 fori con scarico.
3 holes basin set with pop-up waste.

CR



3131D

Batteria lavabo 3 fori senza scarico.
3 holes basin set without waste.

CR



3481D
Gruppo lavabo a ponte senza scarico.
Basin bridge set without waste.

CR



4221D
Batteria bidet 3 fori con scarico.
3 holes bidet set with pop-up waste.

CR



4321D
Rubinetto bidet (coppia).
Bidet faucet (pair).
CR



4921D
Monoforo bidet con scarico.
Single hole bidet set with pop-up waste.

CR



4031D
Bordo bidet 3 fori con doccetta e deviatore.
3 holes bidet set mixer with shower and diverter.

CR



2151D
Gruppo esterno vasca con doccetta.
Wall mtg. bathtub set with handshower.

CR



2231D
Gruppo esterno vasca con accessori.
Wall mtg. bathtub set with accessories.

CR



2311D
Gruppo esterno vasca con accessori e tubo 400 mm.
Wall mtg. bathtub set with accessories and pipe 400 mm.

CR



2551D
Gruppo esterno doccia senza accessori.
Shower set without accessories.

CR

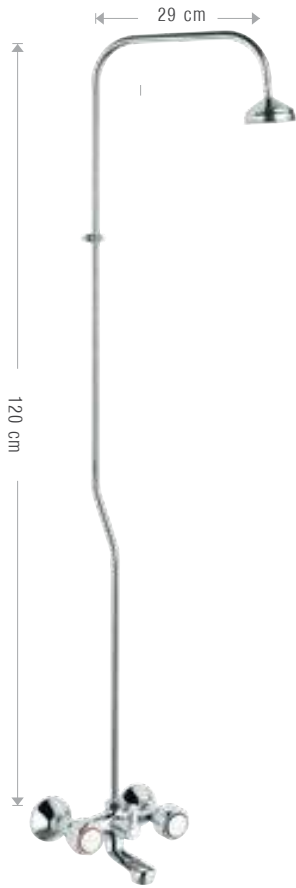

2201D

Gruppo esterno vasca con colonna doccia.
Wall mtg. bathtub set with shower column.

CR

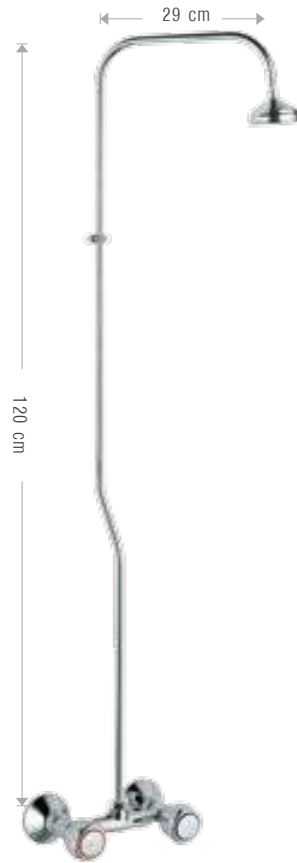

25C1D

Gruppo esterno doccia con colonna doccia.
Wall mtg. shower set with shower column.

CR



5391D

Gruppo doccia monoacqua con colonna doccia.
Wall mtg. single water shower set with shower column.

CR



1121D

Rubinetti arresto da 1/2" a squadra.
1/2" square concealed valve.

CR



3531D

Rubinetti collo cigno.
Basin pillar tap.

CR



3301D

Monoforo lavello bocca girevole.
Single hole sink set with swivel spout.

CR



5021D

Gruppo lavello a parete con bocca girevole.
Wall mgt. sink set with swivel spout.

CR



5141D
 Gruppo lavello a parete con bocca girevole e attacco lavatrice.
 Wall mtg. sink set with swivel spout and washing machine outlet.
 CR



5051D
 Gruppo lavello a parete con bocca girevole.
 Wall mgt. sink set with swivel spout.
 CR



5041D
 Gruppo lavello a parete con bocca girevole.
 Wall mgt. sink set with swivel spout.
 CR



5221D
 Rubinetto prolungato da 1/2".
 1/2" Extended tap.
 CR



5241D
 Rubinetto da 1/2" con attacco lavatrice.
 1/2" Sink tap washing machine outlet.
 CR



5251D
 Rubinetto prolungato da 1/2", 15,5 cm.
 1/2" extended tap, 15,5 cm.
 CR



5331D
 Rubinetto a snodo da 1/2".
 Joint faucet 1/2".
 CR



5401D
 Rubinetto a colonna da 1/2".
 1/2" basin pillar tap.
 CR



5361D
 Rubinetto a squadra.
 Angular tap.
 CR



1021D
 Rubinetto arresto da 1/2".
 1/2" concealed valve.
 CR

WELLNESS	WELLNESS	WELLNESS	WELLNESS
WELLNESS	WELLNESS	WELLNESS	WELLNESS
WELLNESS	WELLNESS	WELLNESS	WELLNESS
WELLNESS	WELLNESS	WELLNESS	WELLNESS
WELLNESS	WELLNESS	WELLNESS	WELLNESS
WELLNESS	WELLNESS	WELLNESS	WELLNESS
WELLNESS	WELLNESS	WELLNESS	WELLNESS
WELLNESS	WELLNESS	WELLNESS	WELLNESS
WELLNESS	WELLNESS	WELLNESS	WELLNESS
WELLNESS	WELLNESS	WELLNESS	WELLNESS
WELLNESS	WELLNESS	WELLNESS	WELLNESS
WELLNESS	WELLNESS	WELLNESS	WELLNESS
WELLNESS	WELLNESS	WELLNESS	WELLNESS
WELLNESS	WELLNESS	WELLNESS	WELLNESS
WELLNESS	WELLNESS	WELLNESS	WELLNESS
WELLNESS	WELLNESS	WELLNESS	WELLNESS
WELLNESS	WELLNESS	WELLNESS	WELLNESS
WELLNESS	WELLNESS	WELLNESS	WELLNESS
WELLNESS	WELLNESS	WELLNESS	WELLNESS
WELLNESS	WELLNESS	WELLNESS	WELLNESS
WELLNESS	WELLNESS	WELLNESS	WELLNESS
WELLNESS	WELLNESS	WELLNESS	WELLNESS
WELLNESS	WELLNESS	WELLNESS	WELLNESS
WELLNESS	WELLNESS	WELLNESS	WELLNESS
WELLNESS	WELLNESS	WELLNESS	WELLNESS

WELLNESS	WELLNESS	WELLNESS	WELLNESS
WELLNESS	WELLNESS	WELLNESS	WELLNESS
WELLNESS	WELLNESS	WELLNESS	WELLNESS
WELLNESS	WELLNESS	WELLNESS	WELLNESS

WELLNESS WELLNESS WELLNESS WELLNESS
WELLNESS WELLNESS WELLNESS WELLNESS
WELLNESS WELLNESS WELLNESS WELLNESS
WELLNESS WELLNESS WELLNESS WELLNESS
WELLNESS WELLNESS WELLNESS WELLNESS
WELLNESS WELLNESS WELLNESS WELLNESS
WELLNESS WELLNESS WELLNESS WELLNESS
WELLNESS WELLNESS WELLNESS WELLNESS
WELLNESS WELLNESS WELLNESS WELLNESS
WELLNESS WELLNESS WELLNESS WELLNESS
WELLNESS WELLNESS WELLNESS WELLNESS
WELLNESS WELLNESS WELLNESS WELLNESS
WELLNESS WELLNESS WELLNESS WELLNESS
WELLNESS WELLNESS WELLNESS WELLNESS
WELLNESS WELLNESS WELLNESS WELLNESS
WELLNESS WELLNESS WELLNESS WELLNESS
WELLNESS WELLNESS WELLNESS WELLNESS
WELLNESS WELLNESS WELLNESS WELLNESS
WELLNESS WELLNESS WELLNESS WELLNESS
WELLNESS WELLNESS WELLNESS WELLNESS
WELLNESS WELLNESS WELLNESS WELLNESS
WELLNESS WELLNESS WELLNESS WELLNESS
WELLNESS WELLNESS WELLNESS WELLNESS

WELLNESS

WELLNESS WELLNESS WELLNESS WELLNESS
WELLNESS WELLNESS WELLNESS WELLNESS
WELLNESS WELLNESS WELLNESS WELLNESS
WELLNESS WELLNESS WELLNESS WELLNESS





CROMOTERAPIA COLORTHERAPY

CROMOTERAPIA
COLORTHERAPYSOFFIONI
SHOWER HEADBOCCHE
SPOUTSBOX INCASSO
BUILT-IN BOXINCASSI
BUILT-INTERMOSTATICI
THERMOSTATICSSET DOCCIA
SHOWER SETPANNELLI DOCCIA
SHOWER PANELSCOLONNE DOCCIA
SHOWER COLUMNSSALISCENDI
SLIDING RAILSDOCCETTE
HAND SHOWERS

SHUFOFF

SET PER BORDO VASCA
DECK MOUNTED BATH TUB SET

IN DOTAZIONE AI MODELLI - SUPPLIED WITH THE MODELS:



Pulsantiera a parete per accensione luce bianca, selezione colori e cromoterapia automatica.
Wall push-button to turn on white light, colors selection and automatic color therapy.



A RICHIESTA AGGIUNGENDO LA LETTERA "W". - ON REQUEST ADDING THE CODE "W".

Pulsantiera wireless per accensione luce bianca, selezione colori e cromoterapia automatica.
Wireless push-button to turn on white light, colors selection and automatic color therapy.

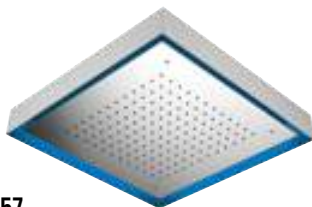

CAQ57



Soffione retroilluminato a soffitto in Acciaio INOX anti-calcare **57x57 cm**, con getto a pioggia. Luce LED a 7 colori con 40 sfumature, alimentazione dalla rete elettrica con trasformatore a basso voltaggio incluso (12V). Pulsantiera a parete inclusa. Ceiling stainless steel backlighted anti-limestone shower head **57x57 cm**, with 1 rain jet. 7 colors light led with 40 shades. Powered by electricity with low voltage transformer included (12V). Wall push-button included.

CR

CAQ57W

Come Art. CAQ57, con pulsantiera wireless inclusa. As art. CAQ57, with wireless remote control included.

CR

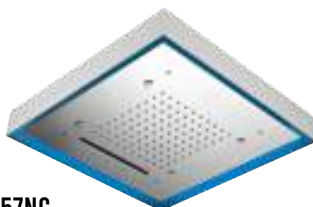

CAQ57NC



Soffione retroilluminato a soffitto in Acciaio INOX anticalcare **57x57 cm**, con 3 funzioni: getto a pioggia, nebulizzazione (4 uscite) ed 1 getto a cascata. Luce LED a 7 colori con 40 sfumature, alimentazione dalla rete elettrica con trasformatore a basso voltaggio incluso (12V). Pulsantiera a parete inclusa.

Ceiling stainless steel backlighted anti-limestone shower head **57x57 cm**, with 3 functions: 1 rain jet, nebulization (4 outlets) and 1 waterfall jet. 7 colors light led with 40 shades. Powered by electricity with low voltage transformer included (12V). Wall push-button included.

CR

CAQ57NCW

Come Art. CAQ57NC, con pulsantiera wireless inclusa. As art. CAQ57NC, with wireless remote control included.

CR

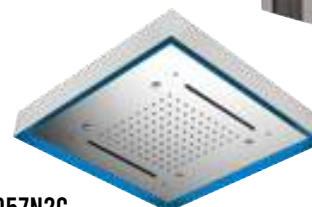

CAQ57N2C



Soffione retroilluminato a soffitto in Acciaio INOX anticalcare **57x57 cm**, con 3 funzioni: getto a pioggia, nebulizzazione (4 uscite) e 2 getti a cascata. Luce LED a 7 colori con 40 sfumature, alimentazione dalla rete elettrica con trasformatore a basso voltaggio incluso (12V). Pulsantiera a parete inclusa.

Ceiling stainless steel backlighted anti-limestone shower head **57x57 cm**, with 3 functions: 1 rain jet, nebulization (4 outlets) and 2 waterfall jets. 7 colors light led with 40 shades. Powered by electricity with low voltage transformer included (12V). Wall push-button included.

CR

CAQ57N2CW

Come Art. CAQ57N2C, con pulsantiera wireless inclusa. As art. CAQ57N2C, with wireless remote control included.

CR

INCASSO FILO SOFFITTO – BUILT-IN SHOWER HEAD

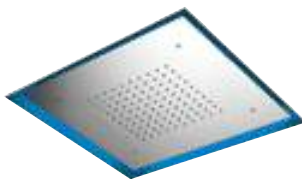

CAIQ57

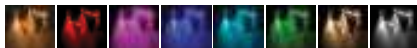

Soffione retroilluminato ad incasso in Acciaio INOX anti-calcare 57x57 cm, con getto a pioggia. Luce LED a 7 colori con 40 sfumature, alimentazione dalla rete elettrica con trasformatore a basso voltaggio incluso (12V). Pulsantiera a parete inclusa. Built-in stainless steel backlighted antilimestone shower head 57x57 cm, with 1 rain jet. 7 colors light led with 40 shades. Powered by electricity with low voltage transformer included (12V). Wall push-button included.

CR

CAIQ57W

Come Art. CAIQ57, con pulsantiera wireless inclusa. As art. CAIQ57, with wireless remote control included.

CR

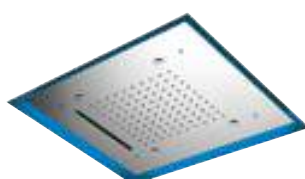

CAIQ57NC

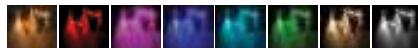

Soffione retroilluminato ad incasso in Acciaio INOX anti-calcare 57x57 cm, con 3 funzioni: getto a pioggia, nebulizzazione (4 uscite) ed 1 getto a cascata. Luce LED a 7 colori con 40 sfumature, alimentazione dalla rete elettrica con trasformatore a basso voltaggio incluso (12V). Pulsantiera a parete inclusa.

Built-in stainless steel backlighted antilimestone shower head 57x57 cm, with 3 functions: 1 rain jet, nebulization (4 outlets) and 1 waterfall jet. 7 colors light led with 40 shades. Powered by electricity with low voltage transformer included (12V). Wall push-button included. Wall push-button included.

CR

CAIQ57NCW

Come Art. CAIQ57NC, con pulsantiera wireless inclusa. As art. CAIQ57NC, with wireless remote control included.

CR

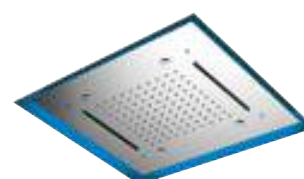

CAIQ57N2C



Soffione retroilluminato ad incasso in Acciaio INOX anti-calcare 57x57 cm, con 3 funzioni: getto a pioggia, nebulizzazione (4 uscite) e 2 getti a cascata. Luce LED a 7 colori con 40 sfumature, alimentazione dalla rete elettrica con trasformatore a basso voltaggio incluso (12V). Pulsantiera a parete inclusa.

Built-in stainless steel backlighted antilimestone shower head 57x57 cm, with 3 functions: 1 rain jet, nebulization (4 outlets) and 2 waterfall jets. 7 colors light led with 40 shades. Powered by electricity with low voltage transformer included (12V). Wall push-button included.

CR

CAIQ57N2CW

Come Art. CAIQ57N2C, con pulsantiera wireless inclusa. As art. CAIQ57N2C, with wireless remote control included.

CR



CAQ57

CROMOTERAPIA
COLOR THERAPY

SOFFIONI
SHOWER HEAD

BOCCHE
SPOUTS

BOX INCASSO
BUILT-IN BOX

INCASSI
BUILT-IN

TERMOSTATICI
THERMOSTATICS

SET DOCCIA
SHOWER SET

PANNELLI DOCCIA
SHOWER PANELS

COLONNE DOCCIA
SHOWER COLUMNS

SLISCENDI
SLIDING RAILS

DOCCETTE
HAND SHOWERS

SHUFOFF

SET PER BORDO VASCA
DECK MOUNTED BATH TUB SET

IN DOTAZIONE AI MODELLI - SUPPLIED WITH THE MODELS:



Pulsantiera a parete per accensione luce bianca, selezione colori e cromoterapia automatica.
Wall push-button to turn on white light, colors selection and automatic color therapy.

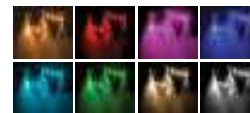

A RICHIESTA AGGIUNGENDO LA LETTERA "W". - ON REQUEST ADDING THE CODE "W".

Pulsantiera wireless per accensione luce bianca, selezione colori e cromoterapia automatica.
Wireless push-button to turn on white light, colors selection and automatic color therapy.

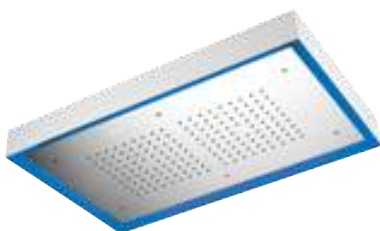

CAR77

Soffione retroilluminato a soffitto in Acciaio INOX anticalcare **77x47 cm**, con 2 postazioni pioggia. Luce LED a 7 colori con 40 sfumature, alimentazione dalla rete elettrica con trasformatore a basso voltaggio incluso (12V). Pulsantiera a parete inclusa.
Ceiling stainless steel backlighted anti-limestone shower head **77x47 cm**, with 2 workstations rain jet. 7 colors light led with 40 shades. Powered by electricity with low voltage transformer included (12V). Wall push-button included.

CR

CAR77W

Come Art. CAR77, con pulsantiera wireless inclusa.
As art. CAR77, with wireless remote control included.

CR

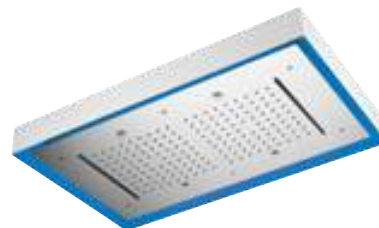

CAR77N2C

Soffione retroilluminato a soffitto in Acciaio INOX anticalcare **77x47 cm**, con 3 funzioni: 2 getti cascata, nebulizzazione (4 uscite) e 2 postazioni pioggia. Luce LED a 7 colori con 40 sfumature, alimentazione dalla rete elettrica con trasformatore a basso voltaggio incluso (12V). Pulsantiera a parete inclusa.
Ceiling stainless steel backlighted anti-limestone shower head **77x47 cm**, with 3 functions: 2 workstations rain jet, nebulization (4 outlets) and 2 waterfall jets. 7 colors light led with 40 shades. Powered by electricity with low voltage transformer included (12V). Wall push-button included.

CR

CAR77N2CW

Come Art. CAR77N2C, con pulsantiera wireless inclusa.
As art. CAR77N2C, with wireless remote control included.

CR

INCASSO FILO SOFFITTO – BUILT-IN SHOWER HEAD

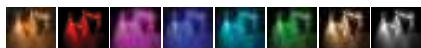
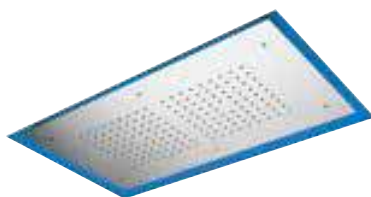

CAIR77

Soffione retroilluminato ad incasso in Acciaio INOX anti-calcare **77x47 cm**, con 2 postazioni pioggia. Luce LED a 7 colori con 40 sfumature, alimentazione dalla rete elettrica con trasformatore a basso voltaggio incluso (12V). Pulsantiera a parete inclusa.
Built-in stainless steel backlighted antilimestone shower head **77x47 cm**, with 2 workstations rain jet. 7 colors light led with 40 shades. Powered by electricity with low voltage transformer included (12V). Wall push-button included.

CR

CAIR77W

Come Art. CAIR77, con pulsantiera wireless inclusa.
As art. CAIR77, with wireless remote control included.

CR

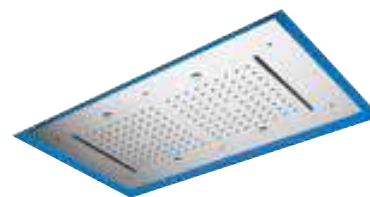

CAIR77N2C

Soffione retroilluminato ad incasso in Acciaio INOX **77x47 cm**, con 3 funzioni: 2 getti cascata, nebulizzazione (4 uscite) e 2 postazioni pioggia. Luce LED a 7 colori con 40 sfumature, alimentazione dalla rete elettrica con trasformatore a basso voltaggio incluso (12V). Pulsantiera a parete inclusa.
Built-in stainless steel backlighted antilimestone shower head **77x47 cm**, with 3 functions: 2 workstations rain jet, nebulization (4 outlets) and 2 waterfall jets. 7 colors light led with 40 shades. Powered by electricity with low voltage transformer included (12V). Wall push-button included.

CR

CAIR77N2CW

Come Art. CAIR77N2C, con pulsantiera wireless inclusa.
As art. CAIR77N2C, with wireless remote control included.

CR



CAIR77N2C

CROMOTERAPIA
COLOR THERAPY

SOFFIONI
SHOWER HEAD

BOCCHE
SPOUTS

BOX INCASSO
BUILT-IN BOX

INCASSI
BUILT-IN

TERMOSTATICI
THERMOSTATICS

SET DOCCIA
SHOWER SET

PANNELLI DOCCIA
SHOWER PANELS

COLONNE DOCCIA
SHOWER COLUMNS

SAISCENDI
SLIDING RAILS

DOCCETTE
HAND SHOWERS

SHUFOFF

SET PER BORDO VASCA
DECK MOUNTED BATH TUB SET

IN DOTAZIONE AI MODELLI - SUPPLIED WITH THE MODELS:



Pulsantiera a parete per accensione luce bianca, selezione colori e cromoterapia automatica.
Wall push-button to turn on white light, colors selection and automatic color therapy.

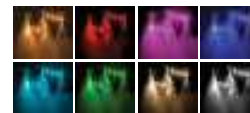

A RICHIESTA AGGIUNGENDO LA LETTERA "W". - ON REQUEST ADDING THE CODE "W".

Pulsantiera wireless per accensione luce bianca, selezione colori e cromoterapia automatica.
Wireless push-button to turn on white light, colors selection and automatic color therapy.



CAT57

Soffione retroilluminato a soffitto in Acciaio INOX anti-calcare **Ø57 cm**, getto pioggia. Luce LED a 7 colori con 40 sfumature, alimentazione dalla rete elettrica con trasformatore a basso voltaggio incluso (12V). Pulsantiera a parete inclusa.
Ceiling stainless steel backlighted anti-limestone shower head **Ø57 cm**, with rain jet. 7 colors light led with 40 shades. Powered by electricity with low voltage transformer included (12V). Wall push-button included.

CR

CAT57W

Come Art. CAT57, con pulsantiera wireless inclusa.
As art. CAT57, with wireless remote control included.

CR



CAT57N

Soffione retroilluminato a soffitto in Acciaio INOX anti-calcare **Ø57 cm**, con 2 funzioni: getto pioggia e nebulizzazione (4 uscite). Luce LED a 7 colori con 40 sfumature, alimentazione dalla rete elettrica con trasformatore a basso voltaggio incluso (12V). Pulsantiera a parete inclusa.
Ceiling stainless steel backlighted anti-limestone shower head **Ø57 cm**, with 2 functions: rain jet and nebulization (4 outlets). 7 colors light led with 40 shades. Powered by electricity with low voltage transformer included (12V). Wall push-button included.

CR

CAT57NW

Come Art. CAT57N, con pulsantiera wireless inclusa.
As art. CAT57N, with wireless remote control included.

CR

INCASSO FILO SOFFITTO – BUILT-IN SHOWER HEAD

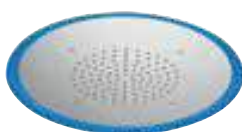

CAIT57

Soffione retroilluminato ad incasso in Acciaio INOX anti-calcare **Ø57 cm**, getto pioggia. Luce LED a 7 colori con 40 sfumature, alimentazione dalla rete elettrica con trasformatore a basso voltaggio incluso (12V). Pulsantiera a parete inclusa.
Built-in stainless steel backlighted antilimestone shower head **Ø57 cm**, with rain jet. 7 colors light led with 40 shades. Powered by electricity with low voltage transformer included (12V). Wall push-button included.

CR

CAIT57W

Come Art. CAIT57, con pulsantiera wireless inclusa.
As art. CAIT57, with wireless remote control included.

CR



CAIT57N

Soffione retroilluminato ad incasso in Acciaio INOX anti-calcare **Ø57 cm**, con 2 funzioni: getto pioggia e nebulizzazione (4 uscite). Luce LED a 7 colori con 40 sfumature, alimentazione dalla rete elettrica con trasformatore a basso voltaggio incluso (12V). Pulsantiera a parete inclusa.
Built-in stainless steel backlighted antilimestone shower head **Ø57 cm**, with 2 functions: rain jet and nebulization (4 outlets). 7 colors light led with 40 shades. Powered by electricity with low voltage transformer included (12V). Wall push-button included.

CR

CAIT57NW

Come Art. CAIT57N, con pulsantiera wireless inclusa.
As art. CAIT57N, with wireless remote control included.

CR



CROMOTERAPIA
COLOR THERAPY

SOFFIONI
SHOWER HEAD

BOCCHE
SPOUTS

BOX INCASSO
BUILT-IN BOX

INCASSI
BUILT-IN

TERMOSTATICI
THERMOSTATICS

SET DOCCIA
SHOWER SET

PANNELLI DOCCIA
SHOWER PANELS

COLONNE DOCCIA
SHOWER COLUMNS

SAISCENDI
SLIDING RAILS

DOCCETTE
HAND SHOWERS

SHUFOFF

SET PER BORDO VASCA
DECK MOUNTED BATH TUB SET

CAT57

IN DOTAZIONE AI MODELLI - SUPPLIED WITH THE MODELS:



Pulsantiera a parete per accensione luce bianca, selezione colori e cromoterapia automatica.
Wall push-button to turn on white light, colors selection and automatic color therapy.



A RICHIESTA AGGIUNGENDO LA LETTERA "W". - ON REQUEST ADDING THE CODE "W".

Pulsantiera wireless per accensione luce bianca, selezione colori e cromoterapia automatica.
Wireless push-button to turn on white light, colors selection and automatic color therapy.

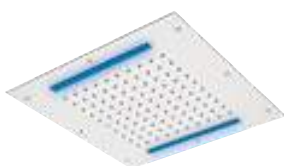

CJQ43

Soffione a soffitto in Acciaio INOX lucidato a specchio 43x43 cm, con getto a pioggia. Luce LED a 7 colori con 40 sfumature, alimentazione dalla rete elettrica con trasformatore a basso voltaggio incluso (12V). Pulsantiera a parete inclusa.
Ceiling stainless steel mirror polished shower head 43x43 cm, rain jet. 7 colors light led with 40 shades. Powered by electricity with low voltage transformer included (12V). Wall push-button included.

CR

CJQ43W

Come soffione Art. CJQ43, con pulsantiera wireless inclusa.
As art. CJQ43, with wireless remote control included.

CR



CJQ50

Soffione a soffitto in Acciaio INOX lucidato a specchio 50x50 cm, con getto a pioggia. Luce LED a 7 colori con 40 sfumature, alimentazione dalla rete elettrica con trasformatore a basso voltaggio incluso (12V). Pulsantiera a parete inclusa.
Ceiling stainless steel mirror polished shower head 50x50 cm, rain jet. 7 colors light led with 40 shades. Powered by electricity with low voltage transformer included (12V). Wall push-button included.

CR

CJQ50W

Come soffione Art. CJQ50, con pulsantiera wireless inclusa.
As art. CJQ50, with wireless remote control included.

CR

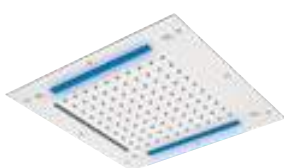

CJQ43NC

Soffione a soffitto in Acciaio INOX lucidato a specchio 43x43 cm, con getto a pioggia, cascata e nebulizzazione. Luce LED a 7 colori con 40 sfumature, alimentazione dalla rete elettrica con trasformatore a basso voltaggio incluso (12V). Pulsantiera a parete inclusa.
Ceiling stainless steel mirror polished shower head 43x43 cm, rain jet, waterfall and nebulizer. 7-color led light with 40 shades. Powered by electricity with low voltage transformer included (12V). Wall push-button included.

Ceiling stainless steel mirror polished shower head 43x43 cm, rain jet, waterfall and nebulizer. 7-color led light with 40 shades. Powered by electricity with low voltage transformer included (12V). Wall push-button included.

CR

CJQ43NCW

Come soffione Art. CJQ43NC, con pulsantiera wireless inclusa.
As art. CJQ43NC, with wireless remote control included.

CR



CJQ50NC

Soffione a soffitto in Acciaio INOX lucidato a specchio 50x50 cm, con getto a pioggia, cascata e nebulizzazione. Luce LED a 7 colori con 40 sfumature, alimentazione dalla rete elettrica con trasformatore a basso voltaggio incluso (12V). Pulsantiera a parete inclusa.
Ceiling stainless steel mirror polished shower head 50x50 cm, rain jet, waterfall and nebulizer. 7-color led light with 40 shades. Powered by electricity with low voltage transformer included (12V). Wall push-button included.

Ceiling stainless steel mirror polished shower head 50x50 cm, rain jet, waterfall and nebulizer. 7-color led light with 40 shades. Powered by electricity with low voltage transformer included (12V). Wall push-button included.

CR

CJQ50NCW

Come soffione Art. CJQ50NC, con pulsantiera wireless inclusa.
As art. CJQ50NC, with wireless remote control included.

CR



CJQ50NC

CROMOTERAPIA
COLOR THERAPY

SOFFIONI
SHOWER HEAD

BOCCHE
SPOUTS

BOX INCASSO
BUILT-IN BOX

INCASSI
BUILT-IN

TERMOSTATICI
THERMOSTATICS

SET DOCCIA
SHOWER SET

PANNELLI DOCCIA
SHOWER PANELS

COLONNE DOCCIA
SHOWER COLUMNS

SALISCENDI
SLIDING RAILS

DOCCETTE
HAND SHOWERS

SHUFOFF

SET PER BORDO VASCA
DECK MOUNTED BATH TUB SET

IN DOTAZIONE AI MODELLI - SUPPLIED WITH THE MODELS:



Pulsantiera a parete per accensione luce bianca, selezione colori e cromoterapia automatica.
Wall push-button to turn on white light, colors selection and automatic color therapy.



A RICHIESTA AGGIUNGENDO LA LETTERA "W". - ON REQUEST ADDING THE CODE "W".

Pulsantiera wireless per accensione luce bianca, selezione colori e cromoterapia automatica.
Wireless push-button to turn on white light, colors selection and automatic color therapy.



CJR70

Soffione a incasso in Acciaio INOX lucidato a specchio 70x40 cm, con 2 postazioni getto a pioggia. Luce LED a 7 colori con 40 sfumature, alimentazione dalla rete elettrica con trasformatore a basso voltaggio incluso (12V). Pulsantiera a parete inclusa.

Built-in stainless steel mirror polished shower head 70x40 cm, 2 rain jet workstations. 7 colors light led with 40 shades. Powered by electricity with low voltage transformer included (12V). Wall push-button included.

CR

CJR70W

Come soffione Art. CJR70, con pulsantiera wireless inclusa.
As art. CJR70, with wireless remote control included.

CR

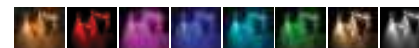
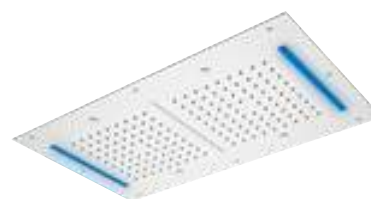

CJR70NC

Soffione a incasso in Acciaio INOX lucidato a specchio 70x40 cm, con 3 funzioni: 2 postazioni getto a pioggia, nebulizzazione (4 uscite) ed 1 getto a cascata centrale. Luce LED a 7 colori con 40 sfumature, alimentazione dalla rete elettrica con trasformatore a basso voltaggio incluso (12V). Pulsantiera a parete inclusa.

Built-in stainless steel mirror polished shower head 70x40 cm, with 3 functions: 2 rain jet workstations, nebulization (4 outlets) and 1 central waterfall jet. 7 colors light led with 40 shades. Powered by electricity with low voltage transformer included (12V). Wall push-button included.

CR

CJR70NCW

Come soffione Art. CJR70NC, con pulsantiera wireless inclusa.
As art. CJR70NC, with wireless remote control included.

CR



GJR70

CROMOTERAPIA
COLOR THERAPY

SOFFIONI
SHOWER HEAD

BOCCHE
SPOUTS

BOX INCASSO
BUILT-IN BOX

INCASSI
BUILT-IN

TERMOSTATICI
THERMOSTATICS

SET DOCCIA
SHOWER SET

PANNELLI DOCCIA
SHOWER PANELS

COLONNE DOCCIA
SHOWER COLUMNS

SAISCENDI
SLIDING RAILS

DOCCETTE
HAND SHOWERS

SHUFOFF

SET PER BORDO VASCA
DECK MOUNTED BATH TUB SET

IN DOTAZIONE AI MODELLI - SUPPLIED WITH THE MODELS:



Pulsantiera a parete per accensione luce bianca, selezione colori e cromoterapia automatica.
Wall push-botton to turn on white light, colors selection and automatic color therapy.

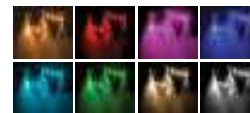

A RICHIESTA AGGIUNGENDO LA LETTERA "W". - ON REQUEST ADDING THE CODE "W".

Pulsantiera wireless per accensione luce bianca, selezione colori e cromoterapia automatica.
Wireless push-botton to turn on white light, colors selection and automatic color therapy.

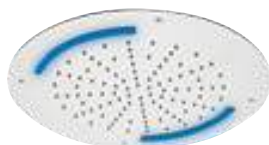

CJT42

Soffione a soffitto in Acciaio INOX lucidato a specchio Ø 42 cm, con getto a pioggia. Luce LED a 7 colori con 40 sfumature, alimentazione dalla rete elettrica con trasformatore a basso voltaggio incluso (12V). Pulsantiera a parete inclusa.
Ceiling stainless steel mirror polished shower head Ø 42 cm, rain jet. 7-colors LED lights with 40 shades. Powered by electricity with low voltage transformer included (12V). Wall push-botton included.

CR

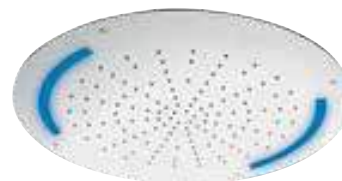

CJT55

Soffione a soffitto in Acciaio INOX lucidato a specchio Ø 55 cm, getto a pioggia. Luce LED a 7 colori con 40 sfumature, alimentazione dalla rete elettrica con trasformatore a basso voltaggio incluso (12V). Pulsantiera a parete inclusa.
Ceiling stainless steel mirror polished shower head Ø 55 cm, rain jet. 7-colors LED lights with 40 shades. Powered by electricity with low voltage transformer included (12V). Wall push-botton included.

CR

CJT42W

Come soffione Art. CJT42, con pulsantiera wireless inclusa.
As art. CJT42, with wireless remote control included.

CR

CJT55W

Come soffione Art. CJT55, con pulsantiera wireless inclusa.
As art. CJT55, with wireless remote control included.

CR

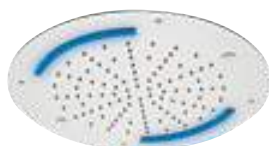

CJT42N

Soffione a soffitto in Acciaio INOX lucidato a specchio Ø 42 cm, con 2 funzioni: getto a pioggia e nebulizzatore. Luce LED a 7 colori con 40 sfumature, alimentazione dalla rete elettrica con trasformatore a basso voltaggio incluso (12V). Pulsantiera a parete inclusa.
Ceiling stainless steel mirror polished shower head, Ø 42 cm, 2 functions: rain jet and nebulizer. 7-colors LED lights with 40 shades. Powered by electricity with low voltage transformer included (12V). Wall push-botton included.

CR

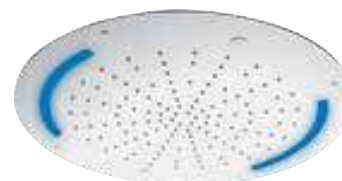

CJT55N

Soffione a soffitto in Acciaio INOX lucidato a specchio Ø 55 cm con 2 funzioni: getto a pioggia e nebulizzatore. Luce LED a 7 colori con 40 sfumature, alimentazione dalla rete elettrica con trasformatore a basso voltaggio incluso (12V). Pulsantiera a parete inclusa.
Ceiling stainless steel mirror polished shower head Ø 55 cm, 2 functions: rain jet and nebulizer. 7-colors LED lights with 40 shades. Powered by electricity with low voltage transformer included (12V). Wall push-botton included.

CR

CJT42NW

Come soffione Art. CJT42N, con pulsantiera wireless inclusa.
As art. CJT42N, with wireless remote control included.

CR

CJT55NW

Come soffione Art. CJT55N, con pulsantiera wireless inclusa.
As art. CJT55N, with wireless remote control included.

CR

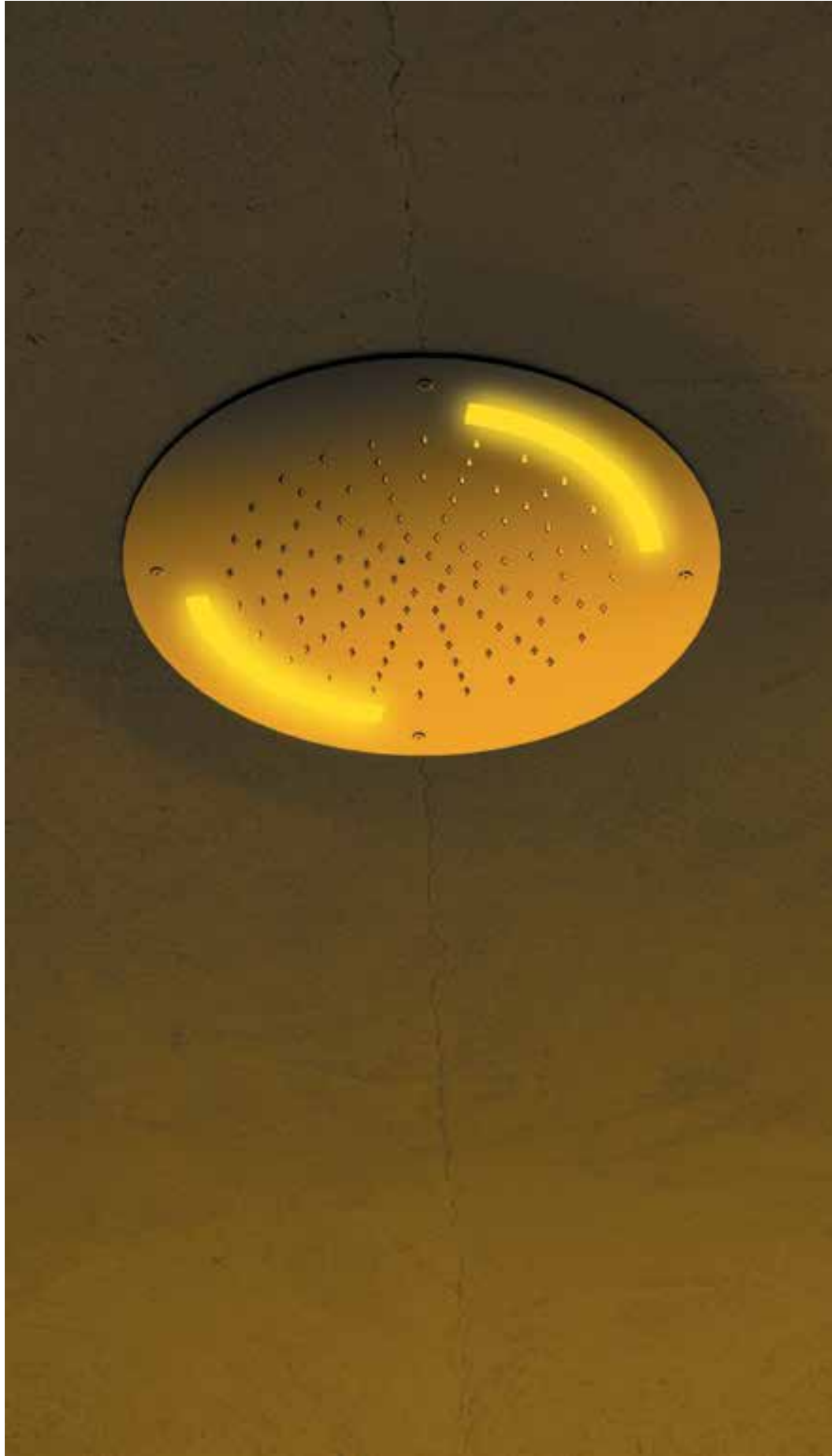

CJT55

CROMOTERAPIA
COLOR THERAPY

SOFFIONI
SHOWER HEAD

BOCCHE
SPOUTS

BOX INCASSO
BUILT-IN BOX

INCASSI
BUILT-IN

TERMOSTATICI
THERMOSTATICS

SET DOCCIA
SHOWER SET

PANNELLI DOCCIA
SHOWER PANELS

COLONNE DOCCIA
SHOWER COLUMNS

SALISCENDI
SLIDING RAILS

DOCCETTE
HAND SHOWERS

SHUFOFF

SET PER BORDO VASCA
DECK MOUNTED BATH TUB SET

IN DOTAZIONE AI MODELLI - SUPPLIED WITH THE MODELS:



Pulsantiera a parete per accensione luce bianca, selezione colori e cromoterapia automatica.
Wall push-button to turn on white light, colors selection and automatic color therapy.

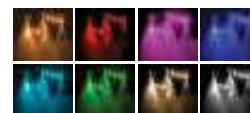

A RICHIESTA AGGIUNGENDO LA LETTERA "W". - ON REQUEST ADDING THE CODE "W".

Pulsantiera wireless per accensione luce bianca, selezione colori e cromoterapia automatica.
Wireless push-button to turn on white light, colors selection and automatic color therapy.



CLT42

Soffione a soffitto in Acciaio INOX lucidato a specchio **Ø42 cm**, con getto a pioggia. Luce LED a 7 colori con 40 sfumature, alimentazione dalla rete elettrica con trasformatore a basso voltaggio incluso (12V). Pulsantiera a parete inclusa.

Ceiling stainless steel mirror polished shower head **Ø42 cm**, with rain jet. 7 colors light led with 40 shades. Powered by electricity with low voltage transformer included (12V). Wall push-button included.

CR

CLT42W

Come soffione Art. CLT42, con pulsantiera wireless inclusa.
As art. CLT42, with wireless remote control included.

CR

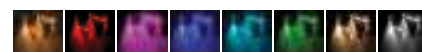

CLT55

Soffione a soffitto in Acciaio INOX lucidato a specchio **Ø55 cm**, con getto a pioggia. Luce LED a 7 colori con 40 sfumature, alimentazione dalla rete elettrica con trasformatore a basso voltaggio incluso (12V). Pulsantiera a parete inclusa.

Ceiling stainless steel mirror polished shower head **Ø55 cm**, with rain jet. 7 colors light led with 40 shades. Powered by electricity with low voltage transformer included (12V). Wall push-button included.

CR

CLT55W

Come soffione Art. CLT55, con pulsantiera wireless inclusa.
As art. CLT55, with wireless remote control included.

CR



CLT55N

Soffione a soffitto in Acciaio INOX lucidato a specchio **Ø55 cm**, con 2 funzioni: getto a pioggia e nebulizzato (4 uscite). Luce LED a 7 colori con 40 sfumature, alimentazione dalla rete elettrica con trasformatore a basso voltaggio incluso (12V). Pulsantiera a parete inclusa.

Ceiling stainless steel mirror polished shower head **Ø55 cm**, with 2 functions: rain jet and nebulization (4 outlets), 7 colors light led with 40 shades. Powered by electricity with low voltage transformer included (12V). Wall push-button included.

CR

CLT55NW

Come soffione Art. CLT55N, con pulsantiera wireless inclusa.
As art. CLT55N, with wireless remote control included.

CR



CLT55

CROMOTERAPIA
COLOR THERAPY

SOFFIONI
SHOWER HEAD

BOCCHE
SPOUTS

BOX INCASSO
BUILT-IN BOX

INCASSI
BUILT-IN

TERMOSTATICI
THERMOSTATICS

SET DOCCIA
SHOWER SET

PANNELLI DOCCIA
SHOWER PANELS

COLONNE DOCCIA
SHOWER COLUMNS

SAISCENDI
SLIDING RAILS

DOCCETTE
HAND SHOWERS

SHUFOFF

SET PER BORDO VASCA
DECK MOUNTED BATH TUB SET

IN DOTAZIONE AI MODELLI - SUPPLIED WITH THE MODELS:



Pulsantiera a parete per accensione luce bianca, selezione colori e cromoterapia automatica.
Wall push-button to turn on white light, colors selection and automatic color therapy.

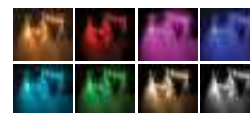

A RICHIESTA AGGIUNGENDO LA LETTERA "W". - ON REQUEST ADDING THE CODE "W".

Pulsantiera wireless per accensione luce bianca, selezione colori e cromoterapia automatica.
Wireless push-button to turn on white light, colors selection and automatic color therapy.

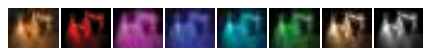

CLQ30

Soffione a soffitto in Acciaio INOX lucidato a specchio **30x30 cm**, getto a pioggia. Luce LED a 7 colori con 40 sfumature, alimentazione dalla rete elettrica con trasformatore a basso voltaggio incluso (12V). Pulsantiera a parete inclusa.
Ceiling stainless steel mirror polished shower head **30x30 cm**, with rain jet. 7 colors light led with 40 shades. Powered by electricity with low voltage transformer included (12V). Wall push-button included.

CR

CLQ30W

Come soffione Art. CLQ30, con pulsantiera wireless inclusa.
As art. CLQ30, with wireless remote control included.

CR



CLQ43

Soffione a soffitto in Acciaio INOX lucidato a specchio **43x43 cm**, getto a pioggia. Luce LED a 7 colori con 40 sfumature, alimentazione dalla rete elettrica con trasformatore a basso voltaggio incluso (12V). Pulsantiera a parete inclusa.
Ceiling stainless steel mirror polished shower head **43x43 cm**, with rain jet. 7 colors light led with 40 shades. Powered by electricity with low voltage transformer included (12V). Wall push-button included.

CR

CLQ43W

Come soffione Art. CLQ43, con pulsantiera wireless inclusa.
As art. CLQ43, with wireless remote control included.

CR

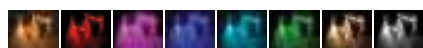

CLQ50

Soffione a soffitto in Acciaio INOX lucidato a specchio **50x50 cm**, getto a pioggia. Luce LED a 7 colori con 40 sfumature, alimentazione dalla rete elettrica con trasformatore a basso voltaggio incluso (12V). Pulsantiera a parete inclusa.
Ceiling stainless steel mirror polished shower head **50x50 cm**, with rain jet. 7 colors light led with 40 shades. Powered by electricity with low voltage transformer included (12V). Wall push-button included.

CR

CLQ50W

Come soffione Art. CLQ50, con pulsantiera wireless inclusa.
As art. CLQ50, with wireless remote control included.

CR

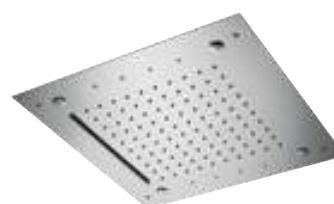

CLQ43NC

Soffione a soffitto in Acciaio INOX lucidato a specchio **43x43 cm**, con 3 funzioni: getto a pioggia, nebulizzazione (4 uscite) e getto a cascata. Luce LED a 7 colori con 40 sfumature, alimentazione dalla rete elettrica con trasformatore a basso voltaggio incluso (12V). Pulsantiera a parete inclusa.
Ceiling stainless steel mirror polished shower head **43x43 cm**, with 3 functions: rain jet, nebulization (4 outlets) and 1 waterfall jet. 7 colors light led with 40 shades. Powered by electricity with low voltage transformer included (12V). Wall push-button included.

CR

CLQ43NCW

Come soffione Art. CLQ43NC, con pulsantiera wireless inclusa.
As art. CLQ43NC, with wireless remote control included.

CR

**CLQ50NC**

Soffione a soffitto in Acciaio INOX lucidato a specchio **50x50 cm**, con 3 funzioni: getto a pioggia, nebulizzazione (4 uscite) e getto a cascata. Luce LED a 7 colori con 40 sfumature, alimentazione dalla rete elettrica con trasformatore a basso voltaggio incluso (12V). Pulsantiera a parete inclusa.

Ceiling stainless steel mirror polished shower head **50x50 cm**, with 3 functions: rain jet, nebulization (4 outlets) and 1 waterfall jet. 7 colors light led with 40 shades. Powered by electricity with low voltage transformer included (12V). Wall push-button included.

CR

CLQ50NCW

Come soffione Art. CLQ50NC, con pulsantiera wireless inclusa. As art. CLQ50NC, with wireless remote control included.

CR

**CLR70**

Soffione a soffitto in Acciaio INOX lucidato a specchio **70x40 cm**, con 2 postazioni getto a pioggia. Luce LED a 7 colori con 40 sfumature, alimentazione dalla rete elettrica con trasformatore a basso voltaggio incluso (12V). Pulsantiera a parete inclusa.

Ceiling stainless steel mirror polished shower head **70x40 cm**, 2 rain jet workstations. 7 colors light led with 40 shades. Powered by electricity with low voltage transformer included (12V). Wall push-button included.

CR

CLR70W

Come soffione Art. CLR70, con pulsantiera wireless inclusa. As art. CLR70, with wireless remote control included.

CR

**CLR70NC**

Soffione a soffitto in Acciaio INOX lucidato a specchio **70x40 cm**, con 3 funzioni: 2 postazioni getto a pioggia, nebulizzazione (4 uscite) ed 1 getto a cascata centrale. Luce LED a 7 colori con 40 sfumature, alimentazione dalla rete elettrica con trasformatore a basso voltaggio incluso (12V). Pulsantiera a parete inclusa.

Ceiling stainless steel mirror polished shower head **70x40 cm**, with 3 functions: 2 rain jet workstations, nebulization (4 outlets) and 1 central waterfall jet. 7 colors light led with 40 shades. Powered by electricity with low voltage transformer included (12V). Wall push-button included.

CR

CLR70NCW

Come soffione Art. CLR70NC, con pulsantiera wireless inclusa. As art. CLR70NC, with wireless remote control included.

CR

**CLR70N2C**

Soffione a soffitto in Acciaio INOX lucidato a specchio **70x40 cm**, con 3 funzioni: getto pioggia, nebulizzazione (4 uscite) e 2 getti a cascata laterali. Luce LED a 7 colori con 40 sfumature, alimentazione dalla rete elettrica con trasformatore a basso voltaggio incluso (12V). Pulsantiera a parete inclusa.

Ceiling stainless steel mirror polished shower head **70x40 cm**, with 3 functions: rain jet, nebulization (4 outlets) and 2 lateral waterfall jet. 7 colors light led with 40 shades. Powered by electricity with low voltage transformer included (12V). Wall push-button included.

CR

CLR70N2CW

Come soffione Art. CLR70N2C, con pulsantiera wireless inclusa. As art. CLR70N2C, with wireless remote control included.

CR

IN DOTAZIONE AI MODELLI - SUPPLIED WITH THE MODELS:



Pulsantiera a parete per accensione luce bianca, selezione colori e cromoterapia automatica.
Wall push-button to turn on white light, colors selection and automatic color therapy.



A RICHIESTA AGGIUNGENDO LA LETTERA "W". - ON REQUEST ADDING THE CODE "W".

Pulsantiera wireless per accensione luce bianca, selezione colori e cromoterapia automatica.
Wireless push-button to turn on white light, colors selection and automatic color therapy.



SR002L

Soffione a parete in Acciaio INOX lucidato a specchio 50x26x6,4 cm, con 1 postazione pioggia. Luce LED a 7 colori con 40 sfumature, alimentazione dalla rete elettrica con trasformatore a basso voltaggio incluso (12V). Con pulsantiera a parete inclusa.

Wall stainless steel mirror polished shower head 50x26x6,4 cm, 1 rain jet workstation. 7 colors light led with 40 shades. Powered by electricity with low voltage transformer included (12V). With wall push-button included.

CR

SR002LW

Come soffione Art. CLQ50, con pulsantiera wireless inclusa.
As art. CLQ50, with wireless remote control included.

CR

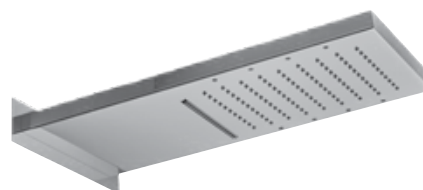

SR003L

Soffione a parete in Acciaio INOX lucidato a specchio 50x26x6,4 cm, con 1 postazione pioggia ed 1 getto a cascata. Luce LED a 7 colori con 40 sfumature, alimentazione dalla rete elettrica con trasformatore a basso voltaggio incluso (12V). Con pulsantiera a parete inclusa.

Wall stainless steel mirror polished shower head 50x26x6,4 cm, 1 rain jet workstation and waterfall jet. 7 colors light led with 40 shades. Powered by electricity with low voltage transformer included (12V). With wall push-button included.

CR

SR003LW

Come soffione Art. CLQ43NC, con pulsantiera wireless inclusa.
As art. CLQ43NC, with wireless remote control included.

CR

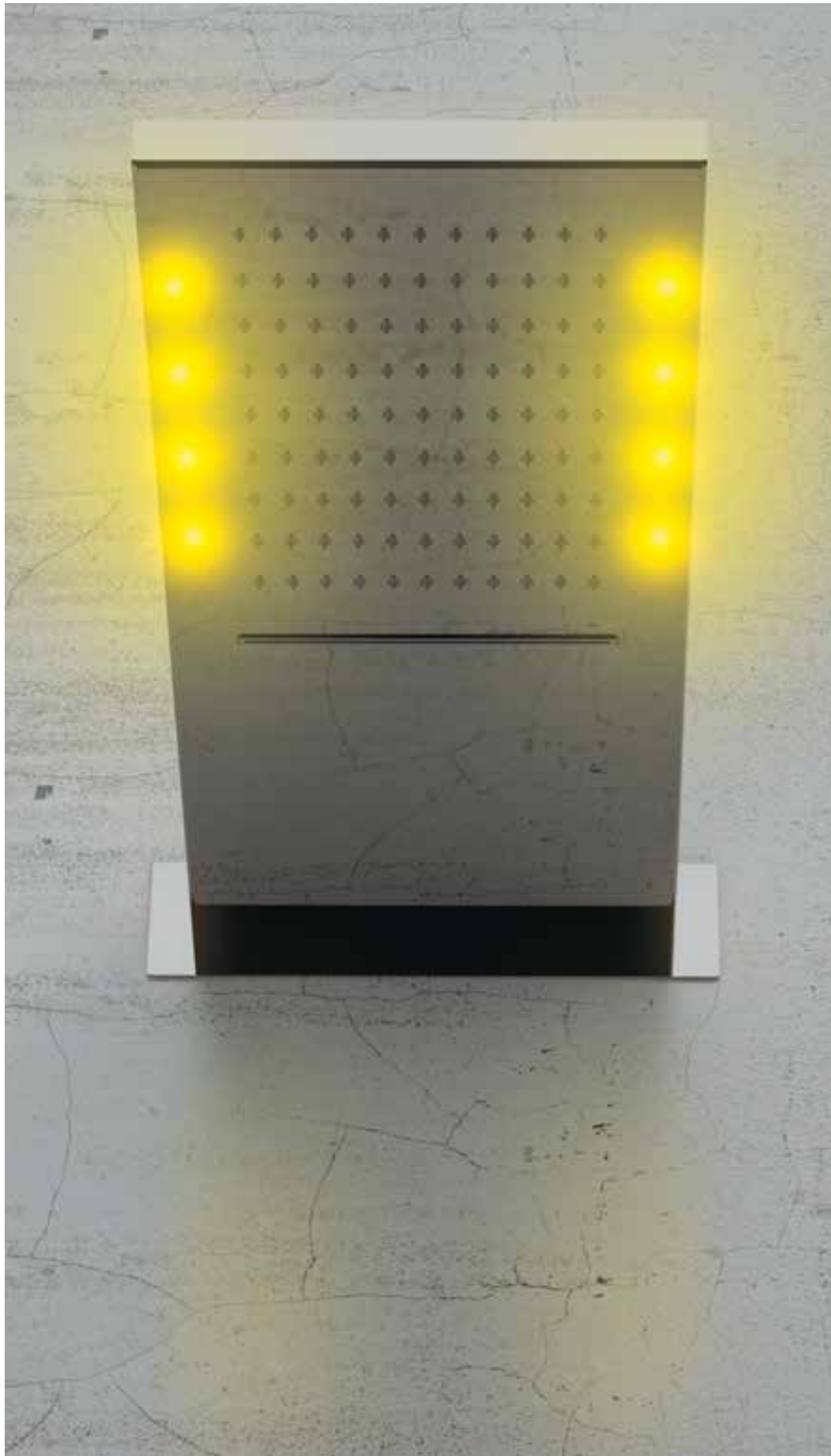

SR003L

CROMOTERAPIA
COLOR THERAPY

SOFFIONI
SHOWER HEAD

BOCCHE
SPOUTS

BOX INCASSO
BUILT-IN BOX

INCASSI
BUILT-IN

TERMOSTATICI
THERMOSTATICS

SET DOCCIA
SHOWER SET

PANNELLI DOCCIA
SHOWER PANELS

COLONNE DOCCIA
SHOWER COLUMNS

SALISCENDI
SLIDING RAILS

DOCCETTE
HAND SHOWERS

SHUFOFF

SET PER BORDO VASCA
DECK MOUNTED BATH TUB SET



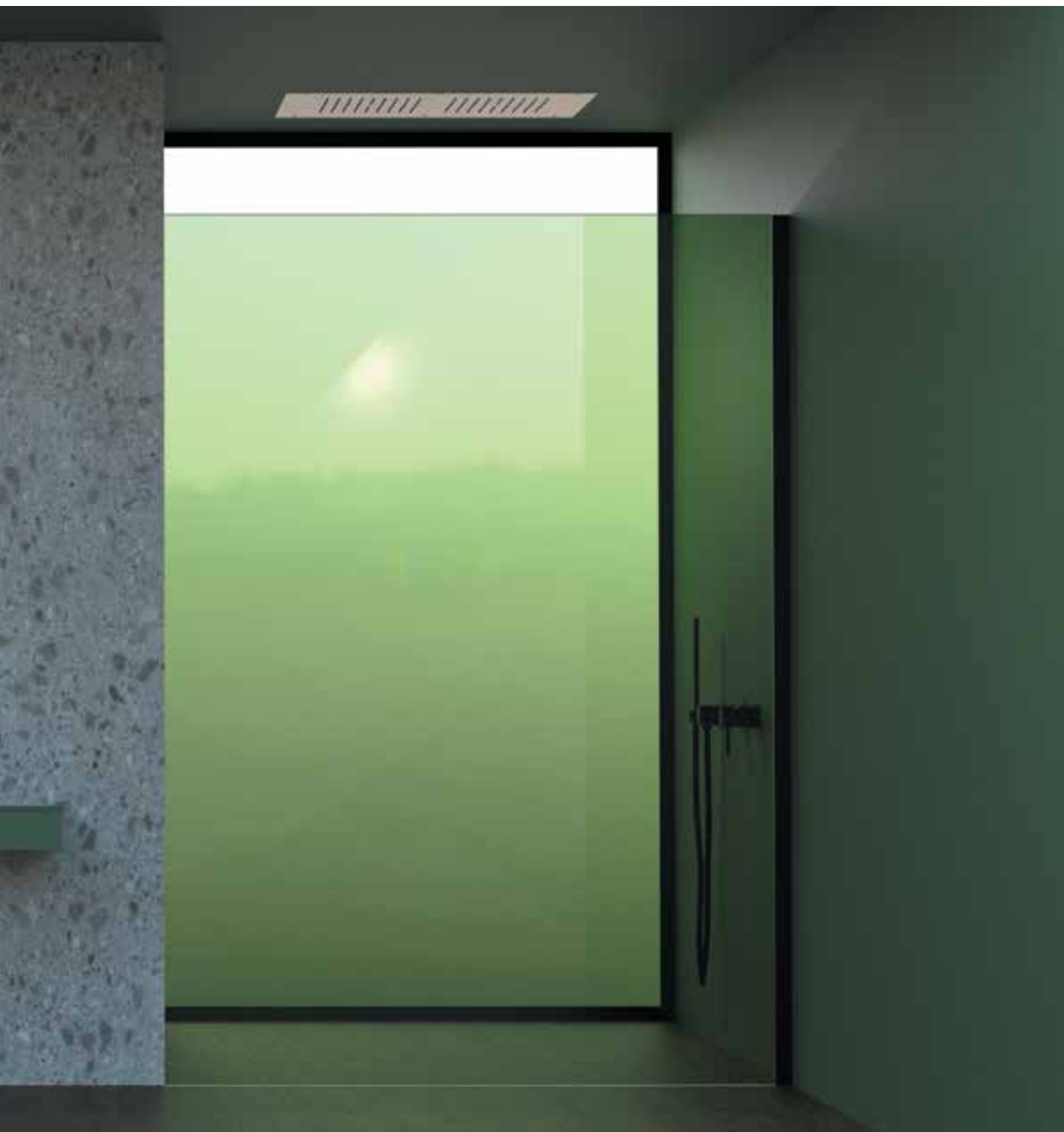

SOFFIONI SHOWER HEAD

CROMOTERAPIA
COLOR THERAPY

SOFFIONI
SHOWER HEAD

BOCCHE
SPOUTS

BOX INCASSO
BUILT-IN BOX

INCASSI
BUILT-IN

TERMOSTATICI
THERMOSTATICS

SET DOCCIA
SHOWER SET

PANNELLI DOCCIA
SHOWER PANELS

COLONNE DOCCIA
SHOWER COLUMNS

SAISCENDI
SLIDING RAILS

DOCCETTE
HAND SHOWERS

SHUFOFF

SET PER BORDO VASCA
DECK MOUNTED BATH TUB SET

SOFFIONI AD INCASSO – BUILT-IN CEILING SHOWER HEADS

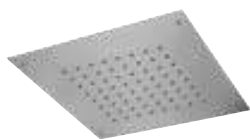

Soffione a soffitto in Acciaio INOX lucidato a specchio con sistema anticalcare, con getto a pioggia.

Ceiling stainless steel mirror polished shower head with anti-limestone system, with rain jet.

SSQ30 30x30 cm

SSQ43 43x43 cm

SSQ50 50x50 cm



Soffione a soffitto in Acciaio INOX lucidato a specchio con sistema anticalcare, a 2 funzioni: getto a pioggia e cascata.

Ceiling stainless steel mirror polished shower head with anti-limestone system, 2 functions: rain and waterfall jet.

SSQ43C 43x43 cm

SSQ50C 50x50 cm



Soffione a soffitto in Acciaio INOX lucidato a specchio con sistema anticalcare, a 3 funzioni: getto a pioggia, nebulizzazione (4 uscite) ed 1 getto a cascata.

Ceiling stainless steel mirror polished shower head with anti-limestone system, 3 functions: rain jet, nebulization (4 outlets) and waterfall jet.

SSQ43NC 43x43 cm

SSQ50NC 50x50 cm



SSR70

Soffione a soffitto in Acciaio INOX con sistema anti-calcare, **70x40 cm**, 2 postazioni pioggia.

Ceiling stainless steel mirror polished shower head with anti-limestone system **70x40 cm**, with 2 rain jet workstations.

CR



SSR70C

Soffione a soffitto in Acciaio INOX con sistema anti-calcare, **70x40 cm**, a 2 funzioni: 2 postazioni pioggia, ed un getto a cascata centrale.

Ceiling stainless steel shower head with anti-limestone system **70x40 cm**, with 2 functions: 2 rain jet workstations and a central waterfall jet.

CR



SSR70NC

Soffione a soffitto in Acciaio INOX lucidato a specchio con sistema anti-calcare, **70x40 cm**, a 3 funzioni: 2 postazioni pioggia, nebulizzazione (4 uscite), ed un getto a cascata centrale.

Ceiling stainless steel shower head with anti-limestone system **70x40 cm**, with 3 functions: 2 rain jet workstations, nebulization (4 outlets) and a central waterfall jet.

CR



SSR70C

CROMOTERAPIA
COLOR THERAPY

SOFFIONI
SHOWER HEAD

BOCCHE
SPOUTS

BOX INCASSO
BUILT-IN BOX

INCASSI
BUILT-IN

TERMOSTATICI
THERMOSTATICS

SET DOCCIA
SHOWER SET

PANNELLI DOCCIA
SHOWER PANELS

COLONNE DOCCIA
SHOWER COLUMNS

SAISCENDI
SLIDING RAILS

DOCCETTE
HAND SHOWERS

SHUFOFF

SET PER BORDO VASCA
DECK MOUNTED BATH TUB SET

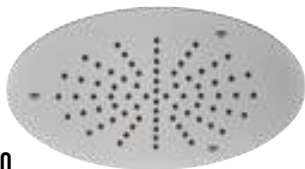

SST30

Soffione a soffitto in Acciaio INOX lucidato a specchio con sistema anti-calcare **Ø30 cm**, con getto a pioggia.
Ceiling stainless steel mirror polished shower head with anti-limestone system **Ø30 cm**, with rain jet.

CR



SST40

Soffione a soffitto in Acciaio INOX lucidato a specchio con sistema anti-calcare **Ø40 cm**, con getto a pioggia.
Ceiling stainless steel mirror polished shower head with anti-limestone system **Ø40 cm**, with rain jet.

CR



SST55

Soffione a soffitto in Acciaio INOX lucidato a specchio con sistema anti-calcare **Ø55 cm**, con getto a pioggia.
Ceiling stainless steel mirror polished shower head with anti-limestone system **Ø55 cm**, with rain jet.

CR



SST42N

Soffione a soffitto in Acciaio INOX lucidato a specchio con sistema anti-calcare **Ø42 cm**, a 2 funzioni: pioggia e nebulizzazione (4 uscite).
Ceiling stainless steel mirror polished shower head with anti-limestone system **Ø42 cm**, with 2 functions: rain jet and nebulization (4 outlets).

CR



SST55N

Soffione a soffitto in Acciaio INOX lucidato a specchio con sistema anti-calcare **Ø55 cm**, a 2 funzioni: pioggia e nebulizzazione (6 uscite).
Ceiling stainless steel mirror polished shower head with anti-limestone system **Ø55 cm**, with 2 functions: rain jet and nebulization (6 outlets).

CR

SOFFIONI "SMART FIX" – "SMART FIX" SHOWER HEADS



SFT34

Soffione doccia SMART FIX in acciaio INOX lucidato a specchio **Ø34 cm**.
SMART FIX stainless steel mirror polished shower head **Ø34 cm**.

CR



SFT44

Soffione doccia SMART FIX in acciaio INOX lucidato a specchio **Ø44 cm**.
SMART FIX stainless steel mirror polished shower head **Ø44 cm**.

CR



SFQ34

Soffione doccia SMART FIX in acciaio INOX lucidato a specchio **34x34 cm**.
SMART FIX stainless steel mirror polished shower head **34x34 cm**.

CR



SFQ44

Soffione doccia SMART FIX in acciaio INOX lucidato a specchio **44x44 cm**.
SMART FIX stainless steel mirror polished shower head **44x44 cm**.

CR

Per questa tipologia di soffione e con questo specifico sistema di fissaggio sono previste quattro molle per ogni soffione.
For this kind of shower-head with this specific mounting system are expected four springs for each shower head.

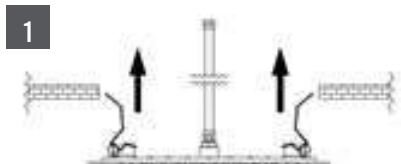

Nell'immagine 1 si evidenzia il primo movimento necessario: caricare due molle vicine tra loro mettendole quasi in posizione verticale rispetto al soffione ed inserirle all'interno del foro precedentemente preparato. Rilasciare le stesse delicatamente.

In picture 1, you shall see the first needed movement to activate them: load two springs close each other placing them vertically in relation to the shower head and insert them in the hole in the ceiling; Release them gently;

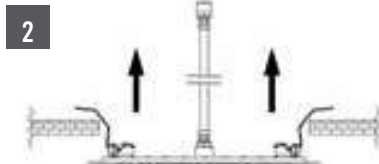

Mantenendo il soffione leggermente inclinato procedere caricando ed inserendo le rimanenti due molle come da immagine 2.
Keeping the shower head slightly inclined, proceed by loading and inserting the two other springs as shown in picture 2.



A questo punto rilasciare delicatamente le molle alla loro naturale tensione e, trattenendo esternamente il soffione, accompagnare lo stesso verso il totale appoggio al soffitto come da immagine 3.

Now release the springs back to their natural tension and, holding the shower head externally, guide it to its final position as shown in picture 3.



CROMOTERAPIA
COLOR THERAPY

SOFFIONI
SHOWER HEAD

BOCCHE
SPOUTS

BOX INCASSO
BUILT-IN BOX

INCASSI
BUILT-IN

TERMOSTATICI
THERMOSTATICS

SET DOCCIA
SHOWER SET

PANNELLI DOCCIA
SHOWER PANELS

COLONNE DOCCIA
SHOWER COLUMNS

SAISCENDI
SLIDING RAILS

DOCCETTE
HAND SHOWERS

SHUFOFF

SET PER BORDO VASCA
DECK MOUNTED BATH TUB SET

SST40

SOFFIONI A MURO – WALL SHOWER HEADS



SR002

Soffione doccia a parete **50X20X3 cm** in Acciaio Inox 1 getto a pioggia.
50x20x3 cm stainless steel wall shower head, 1 rain jet.

CR



SR003

Soffione doccia a parete **50x20x3 cm** in Acciaio Inox 2 getti: pioggia e cascata.
50X20X3 cm stainless steel wall shower head, 2 jets: rain and waterfall.

CR



**SOX002**

Soffione doccia a parete 50x20 cm. in acciaio INOX lucidato a specchio.
Stainless steel mirror polished wall shower head 50x20 cm.

CR

**SOX001**

Soffione doccia a parete 50x20 cm. in acciaio INOX lucidato a specchio, 2 funzioni: a pioggia e cascata.
Stainless steel mirror polished wall shower head 2 functions: rain jet and waterfall, 50x20 cm.

CR



SR003

CROMOTERAPIA
COLOR THERAPYSOFFIONI
SHOWER HEADBOCCHE
SPOUTSBOX INCASSO
BUILT-IN BOXINCASSI
BUILT-INTERMOSTATICI
THERMOSTATICSSET DOCCIA
SHOWER SETPANNELLI DOCCIA
SHOWER PANELSCOLONNE DOCCIA
SHOWER COLUMNSSALISCENDI
SLIDING RAILSDOCCETTE
HAND SHOWERS

SHUFOFF

SET PER BORDO VASCA
DECK MOUNTED BATH TUB SET



SR004

Soffione doccia a parete ultrapiatto **50x22 cm, H 3 mm**, in Acciaio Inox 1 getto a pioggia.
Wall stainless steel ultra-flat shower head **50x22 cm, 3 mm height**, 1 rain jet.

CR



SR005

Soffione doccia a parete ultrapiatto **50x22 cm, H 3 mm** in Acciaio Inox 2 getti: pioggia e cascata.
Wall stainless steel ultra-flat shower head **50x22 cm, 3 mm height**, 2 jets rain and waterfall.

CR



SD002

Soffione doccia ultrapiatto **H 5 mm, 50x22 cm**, a parete in acciaio INOX lucidato a specchio con angoli arrotondati.
5 mm height ultra slim stainless steel mirror polished wall shower head, **50x22 cm** with round corners.

CR



SD003

Soffione doccia ultrapiatto **H 5 mm, 50x22 cm**, a parete in acciaio INOX lucidato a specchio, a 2 funzioni: getto a pioggia e cascata con angoli arrotondati.
5 mm height ultra slim stainless steel mirror polished wall shower head, 2 functions: rain jet and waterfall, **50x22 cm** with round corners.

CR

**S0001**

Soffione doccia a parete ultrapiatto **50x20 cm, H 3 mm**, in Acciaio Inox 1 getto a pioggia.
Wall stainless steel ultra-flat shower head **50x20 cm, 3 mm height**, 1 rain jet

CR

**S0002**

Soffione doccia a parete ultrapiatto **50x20 cm, H 3 mm** in Acciaio Inox 2 getti: pioggia e cascata.
Wall stainless steel ultra-flat shower head **50x20 cm, 3 mm height**, 2 jets rain and waterfall.

CR



S0002

CROMOTERAPIA
COLOR THERAPYSOFFIONI
SHOWER HEADBOCCHE
SPOUTSBOX INCASSO
BUILT-IN BOXINCASSI
BUILT-INTHERMOSTATICI
THERMOSTATICSSET DOCCIA
SHOWER SETPANNELLI DOCCIA
SHOWER PANELSCOLONNE DOCCIA
SHOWER COLUMNSSALISCENDI
SLIDING RAILSDOCCETTE
HAND SHOWERS

SHUFOFF

SET PER BORDO VASCA
DECK MOUNTED BATH TUB SET

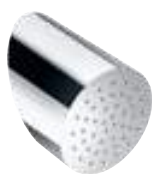

SPT11

Soffione doccia **Ø 15,4 cm**, lunghezza **29,17 cm**, a parete in acciaio INOX lucidato a specchio.
Stainless steel mirror polished wall shower head **Ø15,4 cm**, length **29,17 cm**.

CR



SPQ11

Soffione doccia **15,5x15,5 cm**, lunghezza **25,05 cm**, a parete in acciaio INOX lucidato a specchio.
Stainless steel mirror polished wall shower head **15,5x15,5 cm**, length **25,05 cm**.

CR

SOFFIONI IN ACCIAIO INOX
STAINLESS STEEL SHOWER HEADS



Soffione doccia ultra piatto **20x20 cm** in acciaio INOX lucidato a specchio.
Ultra slim stainless steel mirror polished shower head **20x20 cm**.

SQ00420 20x20 cm

SQ00425 25x25 cm

SQ00430 30x30 cm

SQ00440 40x40 cm



Soffione doccia ultra piatto **Ø 20 cm** in acciaio INOX lucidato a specchio.
Ultra slim stainless steel mirror polished shower head **Ø 20 cm**.

ST00120 Ø20 cm

ST00125 Ø25 cm

ST00130 Ø30 cm

ST00140 Ø40 cm



SR006

Soffione doccia ultra piatto **33x22 cm** in acciaio INOX lucidato a specchio.
Ultra slim stainless steel mirror polished shower head **33x22 cm**.

CR



Soffione doccia ultra piatto **20x20 cm** con angoli arrotondati in acciaio INOX lucidato a specchio.
Ultra slim stainless steel mirror polished shower head **20x20 cm** with round corners.

SD00120 20x20 cm

SD00125 25x25 cm

SD00130 30x30 cm

SD00140 40x40 cm



CROMOTERAPIA
COLOR THERAPY

SOFFIONI
SHOWER HEAD

BOCCHE
SPOUTS

BOX INCASSO
BUILT-IN BOX

INCASSI
BUILT-IN

TERMOSTATICI
THERMOSTATICS

SET DOCCIA
SHOWER SET

PANNELLI DOCCIA
SHOWER PANELS

COLONNE DOCCIA
SHOWER COLUMNS

SLISCENDI
SLIDING RAILS

DOCCETTE
HAND SHOWERS

SHUFOFF

SET PER BORDO VASCA
DECK MOUNTED BATH TUB SET

SPT11

SOFFIONI IN ABS – ABS SHOWER HEADS



Soffione doccia quadrato, in ABS lusso, cromato, con getti in silicone autopulenti e anticalcare.

Chrome plated square deluxe ABS shower head, with silicon self-cleaning and anti-limestone jets.

SQA0120 20x20 cm

SQA0125 25x25 cm

SQA0130 30x30 cm



Soffione doccia minimale Ø 20 cm, in ABS lusso, cromato, con getti in silicone autopulenti e anticalcare.

Chrome plated minimal deluxe ABS shower head, Ø 20 cm, with silicon self-cleaning and anti-limestone jets.

STA0120 Ø20 cm

STA0125 Ø25 cm

STA0130 Ø30 cm

SOFFIONI IN OTTONE – BRASS SHOWER HEADS

CON OPZIONI DI FINITURA – WITH FINISHING OPTIONS

**SQB0120**

Soffione completamente in ottone cromato, con 144 getti in silicone autopulente anticalcare, **cm 20x20**.

Shower head completely in c.p. brass, with 144 jets in silicon, self-cleaning and anti-limestone, **cm 20x20**.

CR

FN (.14.37.08)

**SQB0130**

Soffione a pioggia quadrato piatto, a snodo, **30x30 cm**, cromo, con 144 getti in silicone anticalcare, completamente in ottone.

Squared shower head, completely in c.p. brass, **30x30 cm**, with 144 jets in silicone anti-limestone, with ball-joint.

CR

FN (.14.37.08)

**STB0120**

Soffione doccia minimale piatto in ottone cromato con getti anticalcare in silicone autopulente, **Ø 20 cm**.

Minimal flat c.p. brass anti-limestone shower head with self-cleaning silicon jets, **Ø 20 cm**.

CR

FN (.14.37.08)

**STB0130**

Soffione doccia minimale piatto in ottone cromato con getti in silicone, anticalcare, autopulente, **Ø 30 cm**.

Minimal flat c.p. brass anti-limestone shower head with self-cleaning silicon jets, **Ø 30 cm**.

CR

FN (.14.37.08)

BRACCI DOCCIA – SHOWER ARMS



Braccio doccia in lastra di ottone.
Brass sheet shower arm.

BD00520 20 cm

BD00530 30 cm

BD00540 40 cm



Braccio in ottone con rosetta, 1/2Mx1/2M.
Brass shower arm with wall flange, 1/2Mx1/2M.

BD00930 30 cm

BD00940 40 cm



Braccio doccia in ottone 30 cm senza presa acqua a muro ma con attacco flessibile da 1/2" sul braccio.
Ideale per ristrutturazioni.
Brass arm 30 cm. without wall pipe connection but with flexible connection 1/2" on the arm.
Ideal for renovation.

BD013



Braccio doccia minimale in ottone cromato con deviatore integrato e doppia uscita 1/2" per attacco sia del soffione che del flessibile doccia.
1/2Mx1/2Mx1/2M, cm. 20, 30, 40, 50.
Il deviatore lavora a 0,9 Bar.
Minimal shower arm in c.p. brass with integrated diverter and with double 1/2" outlet to connect both the shower head and the flexible.
1/2Mx1/2Mx1/2M, cm. 20, 30, 40, 50.
The diverter operates at 0,9 Bar.

BD00120 20 cm

BD00130 30 cm

BD00140 40 cm

BD00150 50 cm

CON OPZIONI DI FINITURA – WITH FINISHING OPTIONS



Braccio doccia quadrato in ottone.
Brass square shower arm.

BD00430 30 cm

BD00440 40 cm



Braccio doccia minimale in ottone cromato.
Brass minimal shower arm.

BDL0530 30 cm

BDL0540 40 cm



Braccio doccia tondo in ottone.
Round brass shower arm.

BD00320 20 cm

BD00330 30 cm

BD00340 40 cm

BD00350 50 cm



Braccio doccia a soffitto, quadrato, in ottone.
Brass ceiling square shower arm.

BD00810 10 cm

BD00820 20 cm

BD00830 30 cm

BD00840 40 cm

BD00850 50 cm



Braccio doccia a soffitto, tondo, in ottone.
Brass ceiling round shower arm.

BD00710 10 cm

BD00720 20 cm

BD00730 30 cm

BD00740 40 cm

BD00750 50 cm

SOFFIONI CON BRACCIO SHOWER HEADS WITH ARM



15T08

Soffione in abs cromato Ø 20 cm; braccio a parete in ottone 30 cm (BDL0530).
Ø 20 cm shower head in c.p. abs; 30 cm brass wall arm (BDL0530).

CR



153R0

Soffione Ø 20 cm in ABS cromato (STA0120); braccio a parete in ottone 40 cm (BD00540).
Ø 20 cm shower head in c.p. abs (STA0120); 40 cm brass wall arm (BD00540);

CR



Soffione in ABS cromato (STA0120); braccio a parete in ottone 30 cm (BDL0530).

Shower head in c.p. abs (STA0120); 30 cm brass wall arm (BDL0530).

15T1520 soffione a parete Ø20 cm.
wall shower head Ø20 cm.

15T1525 soffione a parete Ø25 cm.
wall shower head Ø25 cm.

15T1530 soffione a parete Ø30 cm.
wall shower head Ø30 cm.



15T06

Soffione Ø 20 cm in abs cromato (STA0120); braccio a parete in ottone 30 cm (BD00330);

Ø 20 cm shower head in c.p. abs (STA0120); 30 cm brass wall arm (BD00330);

CR



15T01

Soffione Ø 20 cm in ottone (STB0120); braccio a parete in ottone 30 cm (BD00530);

Ø 20 cm brass shower head (STB0120); 30 cm brass wall arm (BD00530);

CR



Soffione ultrapiatto in acciaio INOX lucidato (ST00120); braccio a parete in ottone 30 cm (BDL0530);

Ultra-flat shower head in polished stainless steel (ST00120); 30 cm brass wall arm (BDL0530);

15T1720 soffione a parete Ø20 cm.
wall shower head Ø20 cm.

15T1725 soffione a parete Ø25 cm.
wall shower head Ø25 cm.

15T1730 soffione a parete Ø30 cm.
wall shower head Ø30 cm.



Soffione ultrapiatto in acciaio INOX lucidato (ST00120); braccio a parete in ottone 30 cm (BD00330);

Ultra-flat shower head in polished stainless steel (ST00120); 30 cm brass wall arm (BD00330);

153UM20X soffione a parete Ø20 cm.
wall shower head Ø20 cm.

153UM25X soffione a parete Ø25 cm.
wall shower head Ø25 cm.

153UM30X soffione a parete Ø30 cm.
wall shower head Ø30 cm.



Soffione in abs cromato (SQA0120); braccio a parete in ottone 30 cm (BDL0530); Shower head in c.p. abs (SQA0120); 30 cm brass wall arm (BDL0530);

15Q1520 soffione a parete 20x20 cm.
wall shower head 20x20 cm.

15Q1525 soffione a parete 25x25 cm.
wall shower head 25x25 cm.

15Q1530 soffione a parete 30x30 cm.
wall shower head 30x30 cm.



Soffione ultrapiatto in acciaio INOX lucidato (SQ00420); braccio a parete in ottone 30 cm (BDL0530); Ultra-flat shower head in polished stainless steel (SQ00420); 30 cm brass wall arm (BDL0530);

15Q1720 soffione a parete 20x20 cm.
wall shower head 20x20 cm.

15Q1725 soffione a parete 25x25 cm.
wall shower head 25x25 cm.

15Q1730 soffione a parete 30x30 cm.
wall shower head 30x30 cm.



15Q06

Soffione **20x20 cm** in abs cromato (SQA0120); braccio a parete 30 cm in ottone, forma squadrata (BD00430); **20x20 cm** shower head in c.p. abs (SQA0120); 30 cm brass shower arm, squared shape (BD00430);

CR



15Q10

Soffione **24,5x24,5 cm** in ottone e ABS con braccio a parete 30 cm in ottone, forma squadrata (BD00430); **24,5x24,5 cm** shower head in brass and ABS with 30 cm brass shower arm, squared shape (BD00430);

CR



Soffione ultrapiatto in acciaio INOX lucidato (SQ00420); braccio a parete 30 cm in ottone, forma squadrata (BD00430); Ultra-flat shower head in polished stainless steel (SQ00420); 30 cm brass shower arm, squared shape (BD00430);

15Q07 soffione a parete 20x20 cm.
wall shower head 20x20 cm.

15Q13 soffione a parete 25x25 cm.
wall shower head 25x25 cm.

15Q05 soffione a parete 30x30 cm.
wall shower head 30x30 cm.

CON OPZIONI DI FINITURA – WITH FINISHING OPTIONS



15T11

Soffione Ø 20 cm in ottone (STB0120); braccio a parete in ottone 30 cm (BD00330); Ø 20 cm brass shower head (STB0120); 30 cm brass wall arm (BD00330);

CR

FIN (.14.37.08)



153MA

Soffione 20x20 cm in ottone cromato (SQB0120); braccio a parete 30 cm in ottone, forma squadrata (BD00430); 20x20 cm shower head in c.p. brass (SQB0120); 30 cm brass shower arm, squared shape (BD00430);

CR

FIN (.14.37.08)

SOFFIONI CON BRACCIO A SOFFITTO
SHOWER HEADS WITH CEILING ARM



Ultra-flat shower head in polished stainless steel (SQ00420); 30 cm brass ceiling arm, squared shape (BD00830); Ultra-flat shower head in polished stainless steel (SQ00420); 30 cm brass ceiling arm, squared shape (BD00830);

15Q0920

soffione a parete 20x20 cm.
wall shower head 20x20 cm.

15Q0925

soffione a parete 25x25 cm.
wall shower head 25x25 cm.

15Q0930

soffione a parete 30x30 cm.
wall shower head 30x30 cm.



Soffione ultrapiatto, in acciaio INOX lucidato (ST00120); braccio a soffitto in ottone 30 cm (BD00730); Ultra-flat shower head in polished stainless steel (ST00120); 30 cm brass ceiling arm (BD00730);

15T0720

soffione a parete Ø20 cm.
wall shower head Ø20 cm.

15T0725

soffione a parete Ø25 cm.
wall shower head Ø25 cm.

15T0730

soffione a parete Ø30 cm.
wall shower head Ø30 cm.

**249MND30TA20**

Set doccia composto da: soffione Ø 20 cm in ABS cromato (STA0120); braccio in ottone con deviatore integrato e doppia uscita (BD00130); doccetta a 1 funzione in abs cromato (191HR); supporto snodato orientabile in ABS cromato; flessibile 200 cm (W002122400). Da abbinare a un miscelatore a incasso (NON INCUSO).

Shower set including: Ø 20 cm shower head in c.p. abs (STA0120); 30 cm brass wall arm with diverter and double connection (BD00130); 1-function hand shower in c.p. abs (191HR); adjustable shower holder in c.p. ABS; 200 cm flexible hose (W002122400). To be combined with a built-in mixer (NOT INCLUDED).

CR

**15CNO**

Soffione doccia Ø 20 cm in lastra di ottone con braccio doccia con deviatore art. 15C da 30 cm in ottone.

Ø 20 cm brass head shower with 30 cm brass arm with diverter art. 15C.

CR



249MND30TA20

CROMOTERAPIA
COLOR THERAPYSOFFIONI
SHOWER HEADBOCCHE
SPOUTSBOX INCASSO
BUILT-IN BOXINCASSI
BUILT-INTHERMOSTATICI
THERMOSTATICSSET DOCCIA
SHOWER SETPANNELLI DOCCIA
SHOWER PANELSCOLONNE DOCCIA
SHOWER COLUMNSSALISCENDI
SLIDING RAILSDOCCETTE
HAND SHOWERS

SHUFOFF

SET PER BORDO VASCA
DECK MOUNTED BATH TUB SET

SOFFIONI INOX IN NERO OPACO MATT BLACK STAINLESS STEEL SHOWER HEADS



Soffione doccia nero opaco in acciaio INOX. Getti anticalcare.
Matt black stainless steel shower head, Antilimestone jets.

14ST00120	Ø20 cm
14ST00125	Ø25 cm
14ST00130	Ø30 cm
14ST00140	Ø40 cm



Soffione doccia nero opaco in acciaio INOX. Getti anticalcare.
Matt black stainless steel shower head, Antilimestone jets.

14SQ00420	20x20 cm
14SQ00425	25x25 cm
14SQ00430	30x30 cm
14SQ00440	40x40 cm

SOFFIONI "SMART FIX" – "SMART FIX" SHOWER HEADS



Soffione doccia nero opaco in acciaio INOX. Installazione a soffitto con sistema SMART FIX. Getti anticalcare.
Matt black stainless steel shower head, ceiling mounting with SMART FIX system. Antilimestone jets.

14SFT34	Ø34 cm
14SFT44	Ø44 cm



Soffione doccia nero opaco in acciaio INOX. Installazione a soffitto con sistema SMART FIX. Getti anticalcare.
Matt black stainless steel shower head, ceiling mounting with SMART FIX system. Antilimestone jets.

14SFQ34	34X34 cm
14SFQ44	44X44 cm

Per questa tipologia di soffione e con questo specifico sistema di fissaggio sono previste quattro molle per ogni soffione.
For this kind of shower-head with this specific mounting system are expected four springs for each shower head.

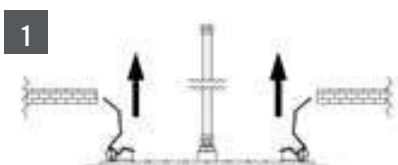

Nell'immagine 1 si evidenzia il primo movimento necessario: caricare due molle vicine tra loro mettendole quasi in posizione verticale rispetto al soffione ed inserirle all'interno del foro precedentemente preparato. Rilasciare le stesse delicatamente.

In picture 1, you shall see the first needed movement to activate them: load two springs close each other placing them vertically in relation to the shower head and insert them in the hole in the ceiling; Release them gently;

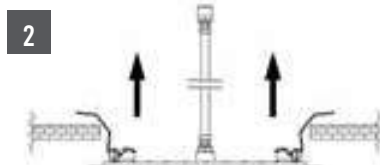

Mantenendo il soffione leggermente inclinato procedere caricando ed inserendo le rimanenti due molle come da immagine 2.

Keeping the shower head slightly inclined, proceed by loading and inserting the two other springs as shown in picture 2.



A questo punto rilasciare delicatamente le molle alla loro naturale tensione e, trattenendo esternamente il soffione, accompagnare lo stesso verso il totale appoggio al soffitto come da immagine 3.

Now release the springs back to their natural tension and, holding the shower head externally, guide it to its final position as shown in picture 3.

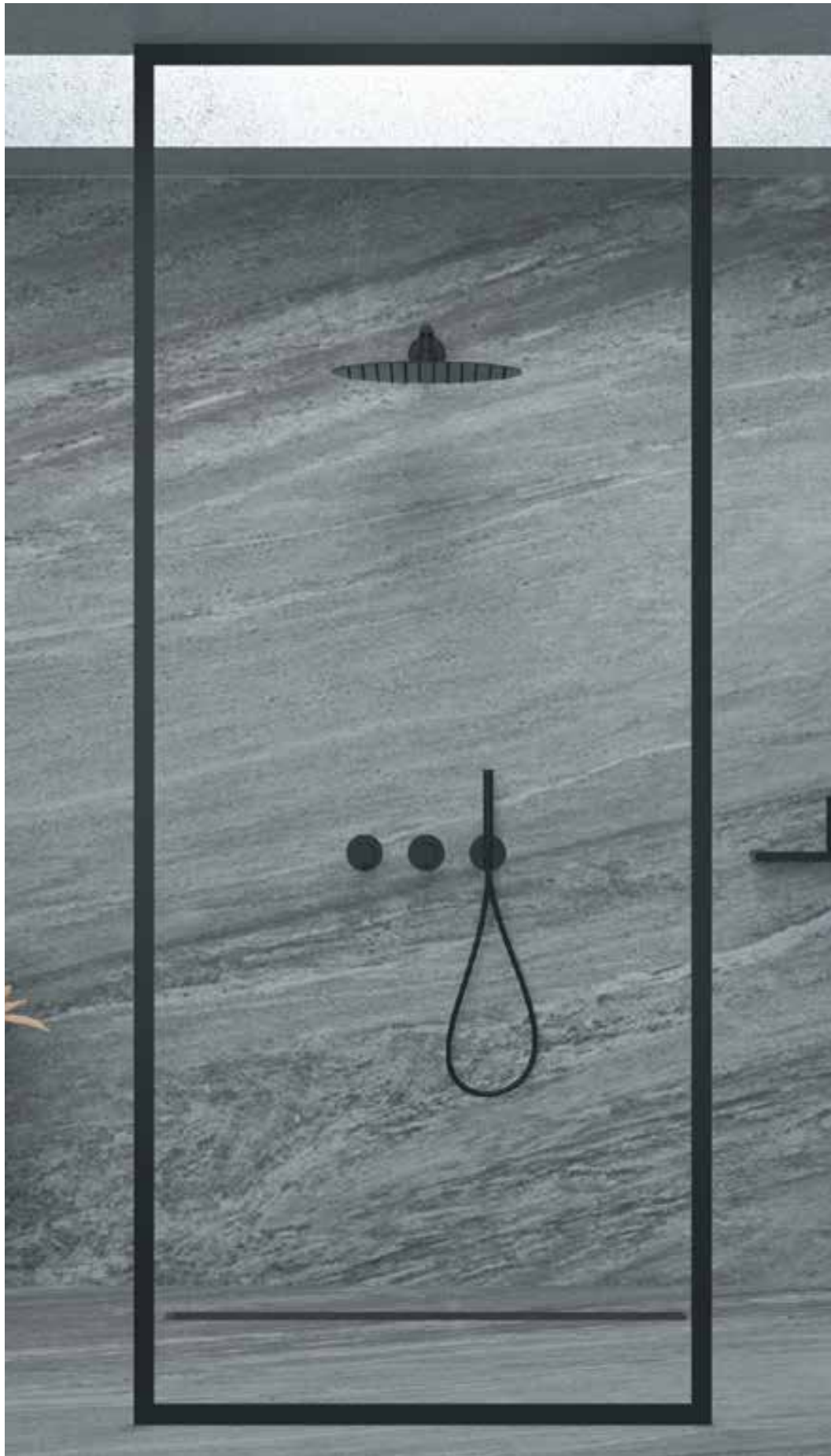

CROMOTERAPIA
COLOR THERAPY

SOFFIONI
SHOWER HEAD

BOCCHE
SPOUTS

BOX INCASSO
BUILT-IN BOX

INCASSI
BUILT-IN

TERMOSTATICI
THERMOSTATICS

SET DOCCIA
SHOWER SET

PANNELLI DOCCIA
SHOWER PANELS

COLONNE DOCCIA
SHOWER COLUMNS

SAISCENDI
SLIDING RAILS

DOCCETTE
HAND SHOWERS

SHUFOFF

SET PER BORDO VASCA
DECK MOUNTED BATH TUB SET

14ST00120



14SOX002

Soffione doccia nero opaco anticalcare 50x20 cm, a parete in acciaio INOX.
Matt black stainless antilimestone steel wall shower head 50x20 cm.

CR



14SOX001

Soffione doccia nero opaco anticalcare 50x20 cm, a parete in acciaio INOX, 2 funzioni: a pioggia e cascata.
Matt black stainless steel antilimestone wall shower head, 2 functions: rain and waterfall, 50x20 cm.

CR



14SR002

Soffione doccia nero opaco anticalcare a parete 50x20 cm, in acciaio INOX.
Matt black stainless steel wall shower head antilimestone 50x20 cm.

CR



14SR003

Soffione doccia nero opaco anticalcare a parete 50x20 cm, in acciaio INOX, 2 funzioni: getto a pioggia e cascata.
Matt black stainless steel wall shower head antilimestone, 2 functions: rain and waterfall, 50x20 cm.

CR



14SO001

Soffione doccia nero opaco anticalcare ultrapiatto 50x20 cm, a parete in acciaio INOX.
Matt black ultraslim antilimestone stainless steel wall shower head 50x20 cm.

CR



14SO002

Soffione doccia nero opaco anticalcare ultrapiatto 50x20 cm, a parete in acciaio INOX, 2 funzioni: pioggia e cascata.
Matt black ultraslim antilimestone stainless steel wall shower head, 2 functions: rain and waterfall, 50x20 cm.

CR



14SR004

Soffione doccia nero opaco anticalcare ultrapiatto 50x22 cm, a parete in acciaio INOX.
Matt black ultraslim antilimestone stainless steel wall shower head 50x22 cm.

CR



14SR005

Soffione doccia nero opaco anticalcare ultrapiatto 50x22 cm, a parete in acciaio INOX, 2 funzioni: getto a pioggia e cascata.
Matt black ultraslim antilimestone stainless steel wall shower head, 2 functions: rain and waterfall, 50x22 cm.

CR



14SR003

SET PER BORDO VASCA
DECK MOUNTED BATHTUB SET

SHUFOFF

DOCCETTE
HAND SHOWERS

SALISCENDI
SLIDING RAILS

COLONNE DOCCIA
SHOWER COLUMNS

PANNELLI DOCCIA
SHOWER PANELS

SET DOCCIA
SHOWER SET

TERMOSTATICI
THERMOSTATICS

INCASSI
BUILT-IN

BOX INCASSO
BUILT-IN BOX

BOCCHE
SPOUTS

SOFFIONI
SHOWER HEAD

CROMOTERAPIA
COLOR THERAPY





BOCCHE SPOUT

CROMOTERAPIA
COLOR THERAPY

SOFFIONI
SHOWER HEAD

BOCCHE
SPOUTS

BOX INCASSO
BUILT-IN BOX

INCASSI
BUILT-IN

TERMOSTATICI
THERMOSTATICS

SET DOCCIA
SHOWER SET

PANNELLI DOCCIA
SHOWER PANELS

COLONNE DOCCIA
SHOWER COLUMNS

SALISCENDI
SLIDING RAILS

DOCCETTE
HAND SHOWERS

SHUFOFF

SET PER BORDO VASCA
DECK MOUNTED BATH TUB SET



GQ001

Soffione a muro per set doccia multigetti 4,2x4,2 cm in ottone, orientabile ed ispezionabile.
Orientable and inspectable side shower head for shower multijet set 4,2x4,2 cm in brass.

CR



GT001

Soffione a muro per set doccia multigetti Ø4 cm In ottone, orientabile ed ispezionabile.
Orientable and inspectable side shower head for shower multijet set Ø4 cm in brass.

CR



13ABC

Bocca incasso con getto a cascata.
Concealed spout with waterfall jet

CR

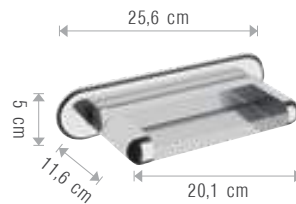

13TBC

Bocca incasso con getto a cascata.
Concealed spout with waterfall jet

CR

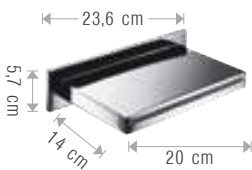

130DC

Bocca incasso con getto a cascata, in Acciaio Inox.
Concealed spout with waterfall jet, stainless steel.

CR

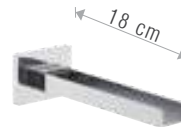

130RI

Bocca incasso a cascata.
Concealed spout, with waterfall jet

CR



13BBC

Bocca incasso con getto a cascata, in Acciaio Inox.
Concealed spout with waterfall jet, stainless steel.

CR



134UMX

Bocca incasso con getto a cascata, in Acciaio Inox.
Concealed spout with waterfall jet, stainless steel.

CR

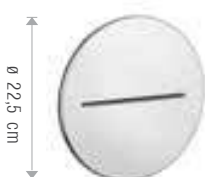

135UMX

Bocca incasso con getto a cascata, in Acciaio Inox.
Concealed spout with waterfall jet, stainless steel.

CR



13BBC

SET PER BORDO VASCA
DECK MOUNTED BATHTUB SET

SHUFOFF

DOCCETTE
HAND SHOWERS

SALISCENDI
SLIDING RAILS

COLONNE DOCCIA
SHOWER COLUMNS

PANNELLI DOCCIA
SHOWER PANELS

SET DOCCIA
SHOWER SET

TERMOSTATICI
THERMOSTATICS

INCASSI
BUILT-IN

BOX INCASSO
BUILT-IN BOX

BOCCHE
SPOUTS

SOFFIONI
SHOWER HEAD

CROMOTERAPIA
COLOR THERAPY



91BSN

Bocca da soffitto in ottone cromato lunghezza 166 cm.
Ceiling spout in chrome plated brass cm 166.
CR

91BSNL

Bocca da soffitto in ottone cromato lunghezza 181 cm.
Ceiling spout in chrome plated brass cm 181.
CR

91BSNR

Bocca da soffitto in ottone cromato lunghezza 166 cm, con dispositivo luce LED nella cartuccia dell'aeratore.
Ceiling spout in chrome plated brass cm 166, with LED device in the aerator cartridge.
CR



91BSNRL

Bocca da soffitto in ottone cromato lunghezza 181 cm, con dispositivo luce LED nella cartuccia dell'aeratore.
Ceiling spout in chrome plated brass cm 181, with LED device in the aerator cartridge.
CR



131SN

Bocca ad incasso. Concealed spout.
CR

13LSN

Bocca incasso tonda con dispositivo luce LED nella cartuccia dell'aeratore.
Concealed round spout with LED device in the aerator cartridge.
CR

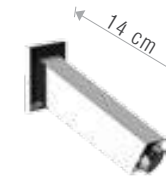

131TW

Bocca ad incasso. Concealed spout.
CR

13LTW

Bocca incasso quarata con dispositivo luce LED nella cartuccia dell'aeratore.
Concealed squared spout with LED device in the aerator cartridge.
CR



Da abbinare agli incassi doccia.
To be combined with concealed shower mixers.



130PA

Bocca incasso, lunghezza bocca 17 cm.
Built-in spout, length spout 17 cm.
CR



130NO

Bocca incasso, lunghezza bocca 18 cm.
Built-in spout, length spout 18 cm.
CR

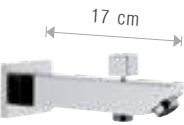

132QD

Bocca incasso con deviatore, lunghezza bocca 17 cm.
Built-in spout with diverter, length spout 17 cm.
CR



132NO

Bocca incasso con deviatore, lunghezza bocca 18 cm.
Built-in spout with diverter, length spout 18 cm.
CR



130SF

Bocca ad incasso. Lunghezza bocca: 18 cm.
Concealed spout. Length spout 18 cm.
CR



91BSNR

CROMOTERAPIA
COLOR THERAPY

SOFFIONI
SHOWER HEAD

BOCCHE
SPOUTS

BOX INCASSO
BUILT-IN BOX

INCASSI
BUILT-IN

TERMOSTATICI
THERMOSTATICS

SET DOCCIA
SHOWER SET

PANNELLI DOCCIA
SHOWER PANELS

COLONNE DOCCIA
SHOWER COLUMNS

SAISCENDI
SLIDING RAILS

DOCCETTE
HAND SHOWERS

SHUFOFF

SET PER BORDO VASCA
DECK MOUNTED BATH TUB SET

La BOX INCASSO di Rubinetterie Mariani è un articolo studiato appositamente per le esigenze di cantiere.

Un incasso universale, compatibile con tutte le collezioni di Rubinetterie Mariani, che permette di portare a termine i lavori di muratura senza dover attendere la scelta finale della rubinetteria da parte del Cliente.

Un servizio migliorativo per tutti i costruttori che possono ora dare alla propria clientela la possibilità di scegliere in tranquillità tra le tante varianti di rubinetteria, senza che questo interferisca con lo stato dei lavori, senza ritardi e senza compromessi nello stile progettuale.

La box incasso è disponibile in 4 diversi modelli in base al numero di uscite acqua da gestire, può supportare miscelatori per doccia a fino a 3 uscite acqua e il miscelatore a incasso per lavabo.

Ogni box consente di alloggiare in un secondo momento le parti complementari di ogni collezione Rubinetterie Mariani con cartuccia sia tradizionale che termostatica, sia con diametro Ø 40 mm che Ø 35 mm.

La box incasso di Rubinetterie Mariani e tutti i suoi componenti sono interamente prodotti in Italia utilizzando i migliori materiali e tecnologie produttive high-tech.

La materia prima utilizzata per il contenitore della box, ad alta densità, è stata appositamente selezionata per essere pratica al taglio, durevole nel tempo, protettiva, resistente e insonorizzante.

Grazie al ridotto spessore della BOX è possibile l'installazione in cartongessi e pareti in legno e rimane comunque e sempre un prodotto ispezionabile nel tempo.

BUILT-IN BOX by Rubinetterie Mariani is an item specifically designed for construction site needs.

A universal built-in part, compatible with all the Rubinetterie Mariani faucet collections, which allows plant and masonry work to be completed without waiting for the final choice of faucets from customers.

An improved service for all the builders who can now give their customers the opportunity to easily choose among the many collections of faucets, without interfering with the state of the work, without any delay and without compromising on the design style.

The built-in box is available with 4 different models based on the number of water outlets to be managed, it can support shower mixers with up to 3 water outlets and the built-in basin mixer. Each box allows the complementary parts of each Rubinetterie Mariani collection to be housed at a later time with both traditional and thermostatic cartridge, with diameters of Ø 40 mm and Ø 35 mm.

The Rubinetterie Mariani built-in box and all its components are entirely produced in Italy using the best materials and high-tech production technologies.

The raw material used for the container of the box, with high density, has been specially selected to be easy-cutting, long-lasting, protective, resistant and soundproofing.

Thanks to the reduced thickness of the BOX, it is possible to install it in plasterboard and wooden walls and still remains a product that can be inspected over time.



BOX INCASSO BUILT-IN BOX

CROMOTERAPIA
COLOR THERAPYSOFFIONI
SHOWER HEADBOCCHE
SPOUTSBOX INCASSO
BUILT-IN BOXINCASSI
BUILT-INTERMOSTATICI
THERMOSTATICSSET DOCCIA
SHOWER SETPANNELLI DOCCIA
SHOWER PANELSCOLONNE DOCCIA
SHOWER COLUMNSSALISCENDI
SLIDING RAILSDOCCETTE
HAND SHOWERS

SHUFOFF

SET PER BORDO VASCA
DECK MOUNTED BATH TUB SET

BOX INCASSO CON 1 O NESSUNA DEVIAZIONE
BUILT-IN BOX WITH 1 OR NO DEVIATION

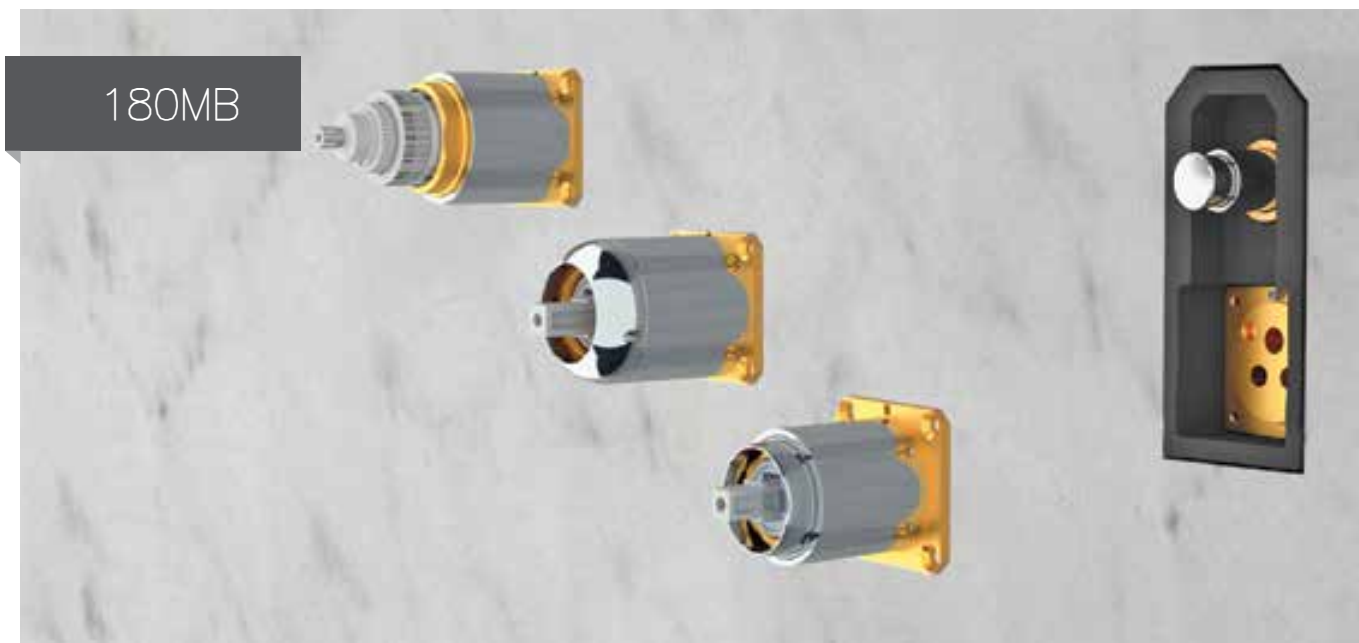

180MB



180MB

Box da incasso per miscelatori doccia con una o nessuna deviazione.
Built-in box for shower mixer with 1 or none deviation.

CR

Questa parte a incasso può essere abbinata a tutti i seguenti modelli di miscelatore per doccia con una o nessuna deviazione, indipendentemente dalla tipologia di cartuccia e di leva.

La materia prima utilizzata per il contenitore della box, ad alta densità, è stata appositamente selezionata per essere pratica al taglio, durevole nel tempo, protettiva, resistente e insonorizzante.

Grazie allo spessore ridotto, è possibile l'installazione in cartongessi e pareti in legno. Dopo l'installazione, il prodotto resta facilmente ispezionabile nel tempo.

This built-in part can be combined with all the following shower mixer models with 1 or none deviation, regardless of the type of cartridge and lever.

The high-density raw material used for the box container has been specially selected to be easy-cutting, long-lasting, protective, resistant and soundproof.

Thanks to the reduced thickness, installation in plasterboard and wooden walls is possible. After installation, the product will always be easy to inspect over time.

CARTUCCIA Ø40 — Ø40 CARTRIDGE

SERIE MAXIMA

SERIE EPIC



180MM



181MM



180E2



181E2

CARTUCCIA Ø35 – Ø35 CARTRIDGE

SERIE AVENUE



180AV

FIN (.14 .37 .08)

181AV

FIN (.14 .37 .08)

SERIE 5TH AVENUE



180AV5

FIN (.14 .37 .08)

181AV5

FIN (.14 .37 .08)

SERIE POLAR



180PA

FIN (.14 .37 .08)

181PA

FIN (.14 .37 .08)

SERIE ARMONIA



180AR

FIN (.14 .08)

181AR

FIN (.14 .08)

SERIE NEXT



180NX

FIN (.14)

181NX

FIN (.14)

SERIE ARTIC



180AT

FIN (.14 .08)

181AT

FIN (.14 .08)

SERIE ULTRAMINIMAL



180UM

FIN (.14 .37 .08)

181UM

FIN (.14 .37 .08)

SERIE RIVER



180RI

181RI

SERIE MARTE



180MA

181MA

SERIE SURF



180SF

181SF

SERIE ESSENZA



180ES

181ES

SERIE HERMES



180HR

181HR

CARTUCCIA TERMOSTATICA – THERMOSTATIC CARTRIDGE

THERMO



180T1

THERMO



181T1

THERMO



180Q1

THERMO



181Q1

CROMOTERAPIA
COLOR THERAPY
SOFFIONI
SHOWER HEAD
BOCCHE
SPOUTS
BOX INCASSO
BUILT-IN BOX
INCASSI
BUILT-IN
THERMOSTATIC
THERMOSTATS
SET DOCCIA
SHOWER SET
PANNELLI DOCCIA
SHOWER PANELS
COLONNE DOCCIA
SHOWER COLUMNS
SALISCENDI
SLIDING RAILS
DOCCIE
HAND SHOWERS
SHUOFF
SET PER BORDO VASCA
DECK MOUNTED BATH TUB SET

BOX INCASSO A 2 VIE – 2 WAYS BUILT-IN BOX

180MBP2



180MBP2

Box da incasso per miscelatore doccia con deviatore a 2 vie.
Built-in box for shower mixer with 2- way diverter.

CR

Questa parte a incasso pu essere abbinata a tutti i seguenti modelli di miscelatore per doccia a 2 vie , indipendentemente dalla tipologia di cartuccia e di leva.

La materia prima utilizzata per il contenitore della box, ad alta densit , stata appositamente selezionata per essere pratica al taglio, durevole nel tempo, protettiva, resistente e insonorizzante.

Grazie allo spessore ridotto, possibile l'installazione in cartongessi e pareti in legno. Dopo l'installazione il prodotto resta facilmente ispezionabile nel tempo.

This built-in part can be combined with all the following shower mixer models with 2-way diverter, regardless of the type of cartridge and lever.

The high-density raw material used for the box container has been specially selected to be easy-cutting, long-lasting, protective, resistant and soundproof.

Thanks to the reduced thickness, installation in plasterboard and wooden walls is possible. After installation, the product will always be easy to inspect over time.

CARTUCCIA Ø35 – Ø35 CARTRIDGE

SERIE AVENUE



180AVP2

FIN (.14 .37 .08)

SERIE 5TH AVENUE



180AV5P2

FIN (.14 .37 .08)

SERIE POLAR

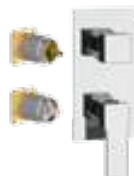

180PAP2

FIN (.14 .37 .08)

SERIE ARMONIA



180ARP2

FIN (.14 .08)

SERIE NEXT



180NXP2

FIN (.14)

SERIE ARTIC



180ATP2

FIN (.14 .08)

SERIE ULTRAMINIMAL



180UMP2

FIN (.14 .37 .08)

SERIE RIVER



180RIP2

SERIE MARTE



180MAP2

SERIE SURF



180SFP2

SERIE ESSENZA



180ESP2

SERIE HERMES



180HRP2

CARTUCCIA TERMOSTATICA – THERMOSTATIC CARTRIDGE

THERMO



180Q1P2

THERMO



180T1P2

CROMOTERAPIA
COLOR THERAPY

SOFFIONI
SHOWER HEAD

BOCCHE
SPOUTS

BOX INCASSO
BUILT-IN BOX

INCASSI
BUILT-IN

TERMOSTATICI
THERMOSTATICS

SET DOCCIA
SHOWER SET

PANNELLI DOCCIA
SHOWER PANELS

COLONNE DOCCIA
SHOWER COLUMNS

SALISCENDI
SLIDING RAILS

DOCCETTE
HAND SHOWERS

SHUOFF

SET PER BORDO VASCA
DECK MOUNTED BATH TUB SET

BOX INCASSO A 3 VIE – 3 WAYS BUILT-IN BOX

180MBP3



180MBP3

Box da incasso per miscelatore doccia con deviatore a 3 vie.
Built-in box for shower mixer with 3-way diverter.

CR

Questa parte a incasso pu essere abbinata a tutti i seguenti modelli di miscelatore per doccia a 3 vie, indipendentemente dalla tipologia di cartuccia e di leva.

La materia prima utilizzata per il contenitore della box, ad alta densità, è stata appositamente selezionata per essere pratica al taglio, durevole nel tempo, protettiva, resistente e insonorizzante.

Grazie allo spessore ridotto, è possibile l'installazione in cartongessi e pareti in legno. Dopo l'installazione, il prodotto resta facilmente ispezionabile nel tempo.

This built-in part can be combined with all the following shower mixer models with 3-way diverter, regardless of the type of cartridge and lever.

The high-density raw material used for the box container has been specially selected to be easy-cutting, long-lasting, protective, resistant and soundproof.

Thanks to the reduced thickness, installation in plasterboard and wooden walls is possible. After installation, the product will always be easy to inspect over time.

CARTUCCIA Ø35 – Ø35 CARTRIDGE

SERIE AVENUE



180AVP3

FIN (.14 .37 .08)

SERIE 5TH AVENUE



180AV5P3

FIN (.14 .37 .08)

SERIE POLAR



180PAP3

FIN (.14 .37 .08)

SERIE ARMONIA



180ARP3

FIN (.14 .08)

SERIE NEXT



180NXP3

FIN (.14)

SERIE ARTIC



180ATP3

FIN (.14 .08)

SERIE ULTRAMINIMAL



180UMP3

FIN (.14 .37 .08)

SERIE RIVER



180RIP3

SERIE MARTE



180MAP3

SERIE SURF



180SFP3

SERIE ESSENZA



180ESP3

SERIE HERMES



180HRP3

CARTUCCIA TERMOSTATICA – THERMOSTATIC CARTRIDGE

THERMO



180Q1P3

THERMO



180T1P3

CROMOTERAPIA
COLOR THERAPY

SOFFIONI
SHOWER HEAD

BOCCHE
SPOUTS

BOX INCASSO
BUILT-IN BOX

INCASSI
BUILT-IN

TERMOSTATICI
THERMOSTATICS

SET DOCCIA
SHOWER SET

PANNELLI DOCCIA
SHOWER PANELS

COLONNE DOCCIA
SHOWER COLUMNS

SAISCENDI
SLIDING RAILS

DOCCETTE
HAND SHOWERS

SHUOFF

SET PER BORDO VASCA
DECK MOUNTED BATH TUB SET

BOX INCASSO PER MISCELATORE LAVABO BUILT-IN BOX FOR BASIN MIXER

567MB



567MB

Box da incasso per miscelatore lavabo con
montaggio a parete.
Built-in box for wall-mounting basin mixer.

CR

Questa parte a incasso pu essere abbinata a tutti i seguenti modelli di miscelatore per lavabo, indipendentemente dalla tipologia di cartuccia e di leva.

La materia prima utilizzata per il contenitore della box, ad alta densità, è stata appositamente selezionata per essere pratica al taglio, durevole nel tempo, protettiva, resistente e insonorizzante.

Grazie allo spessore ridotto, è possibile l'installazione in cartongessi e pareti in legno. Dopo l'installazione, il prodotto resta facilmente ispezionabile nel tempo.

This built-in part can be combined with all the following basin mixer models, regardless of the type of cartridge and lever.

The high-density raw material used for the box container has been specially selected to be easy-cutting, long-lasting, protective, resistant and soundproof.

Thanks to the reduced thickness, installation in plasterboard and wooden walls is possible. After installation, the product will always be easy to inspect over time.

CARTUCCIA Ø35 – Ø35 CARTRIDGE

SERIE AVENUE



567AV 18 cm

FIN (.14 .37 .08)

567AVL 23 cm

FIN (.14 .37 .08)

SERIE 5TH AVENUE



567AV5 18 cm

FIN (.14 .37 .08)

567AV5L 23 cm

FIN (.14 .37 .08)

SERIE POLAR



567PA 18 cm

FIN (.14 .37 .08)

567PAL 23 cm

FIN (.14 .37 .08)

SERIE NEXT



567NX 18 cm

FIN (.14)

SERIE ULTRAMINIMAL



567UM 18 cm

FIN (.14 .37 .08)

SERIE ARTIC



567AT 18 cm

FIN (.14 .08)

SERIE ARMONIA



567AR 18 cm

FIN (.14 .08)

SERIE HERMES



567HR 18 cm

SERIE MARTE



567MA 18 cm

SERIE SURF



567SF 18 cm

SERIE ESSENZA



567ES 18 cm

CROMOTERAPIA
COLOR THERAPYSOFLEONI
SHOWER HEADBOCCHE
SPOUTSBOX INCASSO
BUILT-IN BOXINCASSI
BUILT-INTERMOSTATICI
THERMOSTATSSET DOCCIA
SHOWER SETPANNELLI DOCCIA
SHOWER PANELSCOLONNE DOCCIA
SHOWER COLUMNSSALISCENDI
SLIDING RAILSDOCCETTE
HAND SHOWERS

SHUFOFF

SET PER BORDO VASCA
DECK MOUNTED BATH TUB SET





INCASSI BUILT-IN

CROMOTERAPIA
COLOR THERAPY

SOFFIONI
SHOWER HEAD

BOCCHE
SPOUTS

BOX INCASSO
BUILT-IN BOX

INCASSI
BUILT-IN

TERMOSTATICI
THERMOSTATICS

SET DOCCIA
SHOWER SET

PANNELLI DOCCIA
SHOWER PANELS

COLONNE DOCCIA
SHOWER COLUMNS

SAISCENDI
SLIDING RAILS

DOCCETTE
HAND SHOWERS

SHUFOFF

SET PER BORDO VASCA
DECK MOUNTED BATH TUB SET

DEVIATORI SENZA MISCELATORE – DIVERTERS WITHOUT MIXER



123NO

Deviatore ad incasso 3 vie, portata a 3 Bar.
3 ways concealed diverter, flow rate at 3 Bar.

CR



121NO

Deviatore ad incasso 5 vie, portata a 3 Bar.
5 ways concealed diverter, flow rate at 3 Bar.

CR



123PA

Deviatore ad incasso 3 vie "Polar".
Portata a 3 Bar.
"Polar" 3 ways concealed diverter.
Flow rate at 3 Bar.

CR



121PA

Deviatore ad incasso 5 vie "Polar".
Portata a 3 Bar.
"Polar" 5 ways concealed diverter.
Flow rate at 3 Bar.

CR

MISCELATORI CON DEVIATORE – MIXERS WITH DIVERTERS



173N1

Miscelatore monocomando incasso con deviatore.
Concealed single-lever shower mixer with diverter.

CR



173N2

Miscelatore monocomando per doccia con deviatore a 2 vie su unica piastra.
Portata a 3 Bar.
Single-lever built-in shower mixer with 2 ways diverter on single flange.
Flow rate at 3 Bar.

CR



173N3

Miscelatore monocomando per doccia con deviatore a 3 vie su unica piastra.
Portata a 3 Bar.
Single-lever built-in shower mixer with 3 ways diverter on single flange.
Flow rate at 3 Bar.

CR



173N4

Miscelatore monocomando per doccia con deviatore a 4 vie su unica piastra.
Portata a 3 Bar.
Single-lever built-in shower mixer with 4 ways diverter on single flange.
Flow rate at 3 Bar.

CR

173N5

Miscelatore monocomando per doccia con deviatore a 5 vie su unica piastra.
Portata a 3 Bar.
Single-lever built-in shower mixer with 5 ways diverter on single flange.
Flow rate at 3 Bar.

CR

**173P1**

Miscelatore monocomando incasso con deviatore.
Concealed single-lever shower mixer with diverter.

CR

**173P2**

Miscelatore monocomando per doccia con deviatore a 2 vie su unica piastra.
Portata a 3 Bar.
Single-lever built-in shower mixer with 2 ways diverter on single flange.
Flow rate at 3 Bar.

CR

**173P3**

Miscelatore monocomando per doccia con deviatore a 3 vie su unica piastra.
Portata a 3 Bar.
Single-lever built-in shower mixer with 3 ways diverter on single flange.
Flow rate at 3 Bar.

CR

**173P4**

Miscelatore monocomando per doccia con deviatore a 4 vie su unica piastra.
Portata a 3 Bar.
Single-lever built-in shower mixer with 4 ways diverter on single flange.
Flow rate at 3 Bar.

CR

173P5

Miscelatore monocomando per doccia con deviatore a 5 vie su unica piastra.
Portata a 3 Bar.
Single-lever built-in shower mixer with 5 ways diverter on single flange.
Flow rate at 3 Bar.

CR

CROMOTERAPIA
COLOR THERAPYSOFFIONI
SHOWER HEADBOCCHE
SPOUTSBOX INCASSO
BUILT-IN BOXINCASSI
BUILT-INTHERMOSTATICI
THERMOSTATICSSET DOCCIA
SHOWER SETPANNELLI DOCCIA
SHOWER PANELSCOLONNE DOCCIA
SHOWER COLUMNSSALISCENDI
SLIDING RAILSDOCCETTE
HAND SHOWERS

SHUFOFF

SET PER BORDO VASCA
DECK MOUNTED BATH TUB SET





TERMOSTATICI THERMOSTATIC MIXERS

SET PER BORDO VASCA
DECK MOUNTED BATH TUB SET

SHUFOFF

DOCCETTE
HAND SHOWERS

SALISCENDI
SLIDING RAILS

COLONNE DOCCIA
SHOWER COLUMNS

PANNELLI DOCCIA
SHOWER PANELS

SET DOCCIA
SHOWER SET

TERMOSTATICI
THERMOSTATICS

INCASSI
BUILT-IN

BOX INCASSO
BUILT-IN BOX

BOCCHE
SPOUTS

SOFFIONI
SHOWER HEAD

CROMOTERAPIA
COLOR THERAPY

MISCELATORI TERMOSTATICI A INCASSO EQUILIBRE EQUILIBRE THERMOSTATIC BUILT-IN MIXERS



125T1

Miscelatore **termostatico** da incasso con deviatore per vasca-doccia.
Thermostatic built-in single-lever mixer, with diverter for bath-shower.

CR



126T1

Miscelatore **termostatico** per doccia con deviatore a 2 vie su unica piastra.
Portata a 3 Bar.
Thermostatic built-in shower mixer with 2 ways diverter on single flange.
Flow rate at 3 Bar.

CR



126T2

Miscelatore **termostatico** per doccia con deviatore a 3 vie su unica piastra.
Portata a 3 Bar.
Thermostatic built-in shower mixer with 3 ways diverter on single flange.
Flow rate at 3 Bar.

CR



126T4

Miscelatore **termostatico** per doccia con deviatore a 4 vie su unica piastra.
Portata a 3 Bar.
Thermostatic built-in shower mixer with 4 ways diverter on single flange.
Flow rate at 3 Bar.

CR

126T5

Miscelatore **termostatico** per doccia con deviatore a 5 vie su unica piastra.
Portata a 3 Bar.
Thermostatic built-in shower mixer with 5 ways diverter on single flange.
Flow rate at 3 Bar.

CR

SET DOCCIA TERMOSTATICI EQUILIBRE CON DEVIATORE AUTOMATICO A 2 VIE EQUILIBRE THERMOSTATIC SHOWER SET WITH 2-WAY AUTOMATIC DIVERTER



Set doccia composto da: miscelatore termostatico da incasso con deviatore (125T1); soffione ultrapiatto, in acciaio INOX lucidato (ST00120); braccio a parete in ottone 30 cm (BD00330); doccetta a 1 funzione in abs cromato (191HR); presa acqua a muro con supporto fisso (242MN); flessibile 150 cm.

Shower set including: built-in thermostatic mixer with diverter (125T1); ultra-flat shower head in polished stainless steel (ST00120); 30 cm brass wall arm (BD00330); 1-function hand shower in c.p. abs (191HR); wall connection pipe with shower holder (242MN); 150 cm flexible hose.

17BUWTTX20 con soffione doccia Ø20 cm.
with shower head Ø20 cm.

17BUWTTX25 con soffione doccia Ø25 cm.
with shower head Ø25 cm.

17BUWTTX30 con soffione doccia Ø30 cm.
with shower head Ø30 cm.



17BUWTS0001

Set doccia composto da: miscelatore termostatico da incasso con deviatore (125T1); soffione a parete ultrapiatto effetto pioggia, in acciaio INOX lucidato (S0001); doccetta a 1 funzione in abs cromato (191HR); presa acqua a muro con supporto fisso (242MN); flessibile 150 cm.

Shower set including: built-in thermostatic mixer with diverter (125T1); ultra-flat wall shower head with rain jet, in polished stainless steel (S0001); 1-function hand shower in c.p. abs (191HR); wall connection pipe with shower holder (242MN); 150 cm flexible hose.

CR



17BUWTS0001

CROMOTERAPIA
COLOR THERAPY

SOFFIONI
SHOWER HEAD

BOCCHE
SPOUTS

BOX INCASSO
BUILT-IN BOX

INCASSI
BUILT-IN

TERMOSTATICI
THERMOSTATICS

SET DOCCIA
SHOWER SET

PANNELLI DOCCIA
SHOWER PANELS

COLONNE DOCCIA
SHOWER COLUMNS

SALISCENDI
SLIDING RAILS

DOCCETTE
HAND SHOWERS

SHUFOFF

SET PER BORDO VASCA
DECK MOUNTED BATH TUB SET

SET DOCCIA TERMOSTATICI EQUILIBRE CON DEVIATORE MECCANICO A 2 VIE EQUILIBRE THERMOSTATIC SHOWER SET WITH 2-WAY MECHANICAL DIVERTER



Set doccia composto da: miscelatore termostatico per doccia con deviatore a 2 vie su unica piastra (126T1); soffione ultrapiatto, in acciaio INOX lucidato (ST00120); braccio a parete in ottone 30 cm (BD00330); doccetta a 1 funzione in abs cromato (191HR); presa acqua a muro con supporto fisso (242MN); flessibile 150 cm.

Shower set including: built-in thermostatic mixer with 2-way diverter on single plate (126T1); ultra-flat shower head in polished stainless steel (ST00120); 30 cm brass wall arm (BD00330); 1-function hand shower in c.p. abs (191HR); wall connection pipe with shower holder (242MN); 150 cm flexible hose.

17BUWTP2TX20

con soffione doccia Ø20 cm.
with shower head Ø20 cm.

17BUWTP2TX25

con soffione doccia Ø25 cm.
with shower head Ø25 cm.

17BUWTP2TX30

con soffione doccia Ø30 cm.
with shower head Ø30 cm.



Set doccia composto da: miscelatore termostatico per doccia con deviatore a 2 vie su unica piastra (126T1); soffione ultrapiatto, in acciaio INOX lucidato (ST00120); braccio a parete in ottone 30 cm (BD00330); asta saliscendi cromata; doccetta a 1 funzione in abs cromato (191HR); presa acqua a muro (752N0); flessibile 150 cm.

Shower set including: built-in thermostatic mixer with 2-way diverter on single plate (126T1); ultra-flat shower head in polished stainless steel (ST00120); 30 cm brass wall arm (BD00330); c.p. sliding rail; 1-function hand shower in c.p. abs (191HR); wall connection pipe (752N0); 150 cm flexible hose.

17AUWTP2TX20

con soffione doccia Ø20 cm.
with shower head Ø20 cm.

17AUWTP2TX25

con soffione doccia Ø25 cm.
with shower head Ø25 cm.

17AUWTP2TX30

con soffione doccia Ø30 cm.
with shower head Ø30 cm.



17BUWTP2S0001

Set doccia composto da: miscelatore termostatico per doccia con deviatore a 2 vie su unica piastra (126T1); soffione a parete ultrapiatto effetto pioggia, in acciaio INOX lucidato (S0001); doccetta a 1 funzione in abs cromato (191HR); presa acqua a muro con supporto fisso (242MN); flessibile 150 cm.

Shower set including: built-in thermostatic mixer with 2-way diverter on single plate (126T1); ultra-flat wall shower head with rain jet, in polished stainless steel (S0001); 1-function hand shower in c.p. abs (191HR); wall connection pipe with shower holder (242MN); 150 cm flexible hose.

CR



17AUWTP2S0001

Set doccia composto da: miscelatore termostatico per doccia con deviatore a 2 vie su unica piastra (126T1); soffione a parete ultrapiatto effetto pioggia, in acciaio INOX lucidato (S0001); asta saliscendi cromata; doccetta a 1 funzione in abs cromato (191HR); presa acqua a muro (752N0); flessibile 150 cm.

Shower set including: built-in thermostatic mixer with 2-way diverter on single plate (126T1); ultra-flat wall shower head with rain jet, in polished stainless steel (S0001); c.p. sliding rail; 1-function hand shower in c.p. abs (191HR); wall connection pipe (752N0); 150 cm flexible hose.

CR

SET DOCCIA TERMOSTATICI EQUILIBRE CON DEVIATORE A 3 VIE EQUILIBRE THERMOSTATIC SHOWER SET WITH 3-WAY DIVERTER

17BUWTP3S0002



Set doccia composto da: miscelatore termostatico con deviatore a 3 vie su unica piastra (126T2); soffione a parete ultrapiatto a 2 getti: pioggia e cascata, in acciaio INOX lucidato (S0002); doccetta a 1 funzione in abs cromato (191HR); presa acqua a muro con supporto fisso (242MN); flessibile 150 cm.

Shower set including: built-in thermostatic mixer with 3-way diverter on single plate (126T2); ultra-flat wall shower head with 2 outlets: rain and waterfall, in polished stainless steel (S0002); 1-function hand shower in c.p. abs (191HR); wall connection pipe with shower holder (242MN); 150 cm flexible hose.

CR

17AUWTP3S0002



Set doccia composto da: miscelatore termostatico con deviatore a 3 vie su unica piastra (126T2); soffione a parete ultrapiatto a 2 getti: pioggia e cascata, in acciaio INOX lucidato (S0002); asta saliscendi cromata; doccetta a 1 funzione in abs cromato (191HR); presa acqua a muro (752N0); flessibile 150 cm.

Shower set including: built-in thermostatic mixer with 3-way diverter on single plate (126T2); ultra-flat wall shower head with 2 outlets: rain and waterfall, in polished stainless steel (S0002); c.p. sliding rail; 1-function hand shower in c.p. abs (191HR); wall connection pipe (752N0); 150 cm flexible hose.

CR

17BUWTP3SST42N



Set doccia composto da: miscelatore termostatico con deviatore a 3 vie su unica piastra (126T2); Soffione a soffitto Ø 42 cm a 2 funzioni: pioggia e nebulizzazione (4 uscite) in acciaio INOX lucidato (SST42N); doccetta a 1 funzione in abs cromato (191HR); presa acqua a muro con supporto fisso (242MN); flessibile 150 cm.

Shower set including: built-in thermostatic mixer with 3-way diverter on single plate (126T2); Ø 42 cm ceiling shower head with 2 functions: rain and nebulization (4 outlets), in polished stainless steel (SST42N); 1-function hand shower in c.p. abs (191HR); wall connection pipe with shower holder (242MN); 150 cm flexible hose.

CR

17AUWTP3SST42N



Set doccia composto da: miscelatore termostatico con deviatore a 3 vie su unica piastra (126T2); soffione a soffitto Ø 42 cm a 2 funzioni: pioggia e nebulizzazione (4 uscite) in acciaio INOX lucidato (SST42N); asta saliscendi cromata; doccetta a 1 funzione in abs cromato (191HR); presa acqua a muro (752N0); flessibile 150 cm.

Shower set including: built-in thermostatic mixer with 3-way diverter on single plate (126T2); Ø 42 cm ceiling shower head with 2 functions: rain and nebulization (4 outlets), in polished stainless steel (SST42N); c.p. sliding rail; 1-function hand shower in c.p. abs (191HR); wall connection pipe (752N0); 150 cm flexible hose.

CR

CROMOTERAPIA
COLOR THERAPYSOFFIONI
SHOWER HEADBOCCHE
SPOUTSBOX INCASSO
BUILT-IN BOXINCASSI
BUILT-INTERMOSTATICI
THERMOSTATICSSET DOCCIA
SHOWER SETPANNELLI DOCCIA
SHOWER PANELSCOLONNE DOCCIA
SHOWER COLUMNSSALISCENDI
SLIDING RAILSDOCCETTE
HAND SHOWERS

SHUFFO

SET PER BORDO VASCA
DECK MOUNTED BATH TUB SET



17AUWTP3SST42N



EQUILIBRE

La collezione EQUILIBRE, progettata e realizzata da Rubinetterie Mariani, si compone di soluzioni con miscelazione termostatica. Un comfort dedicato agli ambienti vasca e doccia per impostare la temperatura desiderata dell'acqua prima della sua apertura e per mantenerla costante durante tutto l'utilizzo.

Il contenuto tecnologico di EQUILIBRE si inserisce all'interno di un design elegante e minimale, dalle forme tonde che possono essere utilizzate con successo in progetti dal gusto sia classico che moderno.

The EQUILIBRE collection, engineered and designed by Rubinetterie Mariani, consists of solutions with thermostatic mixing. A comfort dedicated to the bath and shower designs to set the desired water temperature before opening it and to keep it constant throughout use.

The technological content of EQUILIBRE fits into an elegant and minimal design, with round shapes that can be successfully combined with both classic and modern furnishings.



270T3

Termostatico tondo con attacco inferiore 1/2".
Round thermostatic mixer with 1/2" lower connection.

CR



273T3

Termostatico tondo doppia uscita, inferiore 1/2", superiore 3/4" con deviatore integrato nella maniglia.
Round thermostatic mixer with double outlet, 1/2" lower connection, 3/4" upper connection, with diverter integrated in the handle.

CR

CROMOTERAPIA
COLOR THERAPY

SOFFIONI
SHOWER HEAD

BOCCHE
SPOUTS

BOX INCASSO
BUILT-IN BOX

INCASSI
BUILT-IN

TERMOSTATICI
THERMOSTATICS

SET DOCCIA
SHOWER SET

PANNELLI DOCCIA
SHOWER PANELS

COLONNE DOCCIA
SHOWER COLUMNS

SALISCENDI
SLIDING RAILS

DOCCETTE
HAND SHOWERS

SHUFOFF

SET PER BORDO VASCA
DECK MOUNTED BATH TUB SET

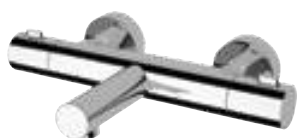

272T3

Termostatico tondo per vasca con attacco da 1/2" per flessibile doccia.
Round bathtub thermostatic mixer with 1/2" outlet for shower flexible.

CR



27AT3

Termostatico tondo doppia uscita, inferiore 1/2", superiore 1/2" con deviatore integrato nella maniglia.
Round thermostatic mixer with double outlet, 1/2" lower connection, 1/2" upper connection, with diverter integrated in the handle.

CR



274T3

Termostatico tondo doppia uscita, inferiore 1/2", superiore 3/4" con deviatore integrato nella maniglia.
Round thermostatic mixer with double outlet, 1/2" lower connection, 3/4" upper connection, with diverter integrated in the handle.

CR



271

Termostatico con attacco superiore da 3/4".
Thermostatic mixer with 3/4" upper connection.

CR



270

Termostatico con attacco inferiore da 1/2".
Thermostatic mixer with 1/2" lower connection.

CR



272

Termostatico esterno per vasca con attacco da 1/2" per flessibile doccia.
Thermostatic bathtub mixer with 1/2" outlet for shower flexible.

CR



2702T

Termostatico con attacco inferiore da 1/2".
Thermostatic mixer with 1/2" lower connection.

CR

COLONNE DOCCIA TERMOSTATICHE EQUILIBRE EQUILIBRE THERMOSTATIC SHOWER COLUMNS



Colonna doccia composta da: miscelatore termostatico esterno con doppia uscita (273T3); soffione ultrapiatto, in acciaio INOX lucidato (ST00120); colonna con fissaggio superiore scorrevole; doccetta a 1 funzione in abs cromato (191HR); flessibile 150 cm.
Shower column including: exposed thermostatic mixer with double connection (273T3); ultra-flat shower head in polished stainless steel (ST00120); column with sliding upper fixing; 1-function hand shower in c.p. abs (191HR); 150 cm flexible hose.

A66T3V1 Ø 20cm

A66T3V2 Ø 25cm

A66T3V2TX30 Ø 30cm



Colonna doccia composta da: miscelatore termostatico esterno con doppia uscita (273T3); soffione in ABS cromato (STA0120); colonna con fissaggio superiore scorrevole; doccetta a 4 funzioni in abs cromato con getti in silicone; flessibile 150 cm.

Shower column including: exposed thermostatic mixer with double connection (273T3); Ø 20 cm shower head in c.p. abs (STA0120); column with sliding upper fixing; 4-function hand shower in chromed abs with silicone jets; 150 cm flexible hose.

A66T3 Ø 20cm

A66T3TA25 Ø 25cm

A66T3TA30 Ø 30cm

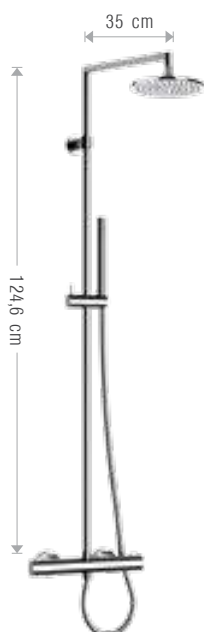

Colonna doccia composta da: miscelatore termostatico esterno con doppia uscita e deviatore integrato (27AT3); soffione Ø 20 cm in ottone (STB0120); colonna in ottone; doccetta a 1 funzione in ottone cromato (191D6); flessibile 150 cm.

Shower column including: exposed thermostatic mixer with double connection and diverter (27AT3); Ø 20 cm brass shower head (STB0120); brass column; 1-function brass hand shower (191D6); 150 cm flexible hose.

A48DF Ø 20cm



Colonna doccia composta da: miscelatore termostatico esterno con attacco superiore (271); soffione a campana in ottone Ø 20 cm; colonna con deviatore; doccetta a 1 funzione, in ottone (191TS); flessibile 150 cm.

Shower column including: exposed thermostatic mixer with upper connection (271); Ø 20 cm brass bell shower head; column with diverter; 1-function brass hand shower (191TS); 150 cm flexible hose.

A43CD Ø 20cm

CROMOTERAPIA
COLOR THERAPYSOFFIONI
SHOWER HEADBOCCHE
SPOUTSBOX INCASSO
BUILT-IN BOXINCASSI
BUILT-INTERMOSTATICI
THERMOSTATICSSET DOCCIA
SHOWER SETPANNELLI DOCCIA
SHOWER PANELSCOLONNE DOCCIA
SHOWER COLUMNSSALISCENTI
SLIDING RAILSDOCCETTE
HAND SHOWERS

SHUOFF

SET PER BORDO VASCA
DECK MOUNTED BATH TUB SET



27AT3



Colonna doccia composta da: miscelatore termostatico esterno con attacco superiore (271); soffione a pioggia in abs; colonna girevole con deviatore; doccetta a 1 funzione in abs cromato (191HR); flessibile 150 cm.
Shower column including: exposed thermostatic mixer with upper connection (271); rain shower head in abs; swivel column with diverter; 1-function hand shower in c.p. abs (191HR); 150 cm flexible hose.

A37CD Ø 24cm

CON OPZIONI DI FINITURA
WITH FINISHING OPTIONS



273T3BUTB20

Colonna doccia composta da: miscelatore termostatico esterno con doppia uscita e deviatore integrato, maniglie in ottone (27AT3B); soffione Ø 20 cm in ottone (STB0120); colonna girevole con deviatore; doccetta a 1 funzione in ottone cromato (191D6); flessibile 150 cm.
Shower column including: exposed thermostatic mixer with double connection and diverter, brass handles (27AT3B); Ø 20 cm brass shower head (STB0120); swivel column with diverter; 1-function brass hand shower (191D6); 150 cm flexible hose.

CR

FIN (.14 .37 .08)



273T3BUTB20

CROMOTERAPIA
COLOR THERAPY

SOFFIONI
SHOWER HEAD

BOCCHE
SPOUTS

BOX INCASSO
BUILT-IN BOX

INCASSI
BUILT-IN

TERMOSTATICI
THERMOSTATICS

SET DOCCIA
SHOWER SET

PANNELLI DOCCIA
SHOWER PANELS

COLONNE DOCCIA
SHOWER COLUMNS

SALISCENDI
SLIDING RAILS

DOCCETTE
HAND SHOWERS

SHU-OFF

SET PER BORDO VASCA
DECK MOUNTED BATH TUB SET



Colonna doccia composta da: miscelatore termostatico esterno con doppia uscita (273T3); colonna con fissaggio superiore scorrevole e deviatore; soffione in abs cromato (SQA0120); doccetta a 1 funzione in abs cromato (191QD); flessibile 150 cm.

Shower column including: exposed thermostatic mixer with double connection (273T3); column with sliding upper fixing and diverter; shower head in c.p. abs (SQA0120); 1-function hand shower in c.p. abs (191QD); flexible hose 150 cm.

A66T3V3QA20 20x20cm

A66T3V3QA25 25x25cm

A66T3V3QA30 30x30cm



Colonna doccia composta da: miscelatore termostatico esterno con doppia uscita (273T3); soffione ultrapiatto con angoli arrotondati in acciaio INOX lucidato (SD00120); colonna con fissaggio superiore scorrevole; doccetta a 1 funzione in abs cromato (191QD); flessibile 150 cm.

Shower column including: exposed thermostatic mixer with double connection (273T3); ultra-flat shower head with rounded corners in polished stainless steel (SD00120); column with sliding upper fixing; 1-function hand shower in c.p. abs (191QD); 150 cm flexible hose.

A66T3V3 20x20cm

A66T3V3DX25 25x25cm

A66T3V3DX30 30x30cm

COLONNE DOCCIA TELESCOPICHE E TERMOSTATICHE EQUILIBRE EQUILIBRE TELESCOPIC THERMOSTATIC SHOWER COLUMNS

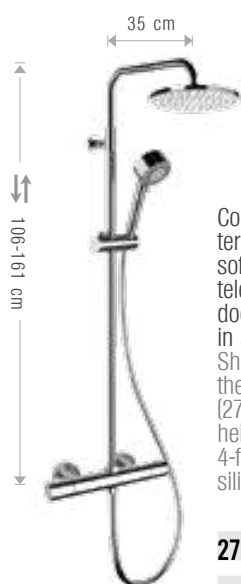

Colonna doccia composta da: miscelatore termostatico esterno con doppia uscita (273T3); soffione in ABS cromato (STA0120); colonna telescopica in ottone con altezza regolabile; doccetta a 4 funzioni in abs cromato con getti in silicone; flessibile 150 cm.

Shower column including: exposed thermostatic mixer with double connection (273T3); shower head in c.p. abs (STA0120); height-adjustable telescopic brass column; 4-function hand shower in chromed abs with silicone jets; 150 cm flexible hose.

273T3A04 Ø 20cm

273T3ATA25 Ø 25cm

273T3ATA30 Ø 30cm

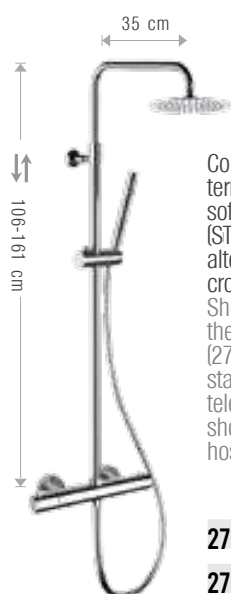

Colonna doccia composta da: miscelatore termostatico esterno con doppia uscita (273T3); soffione ultrapiatto, in acciaio INOX lucidato (ST00120); colonna telescopica in ottone con altezza regolabile; doccetta a 1 funzione in abs cromato (191HR); flessibile 150 cm.

Shower column including: exposed thermostatic mixer with double connection (273T3); ultra-flat shower head in polished stainless steel (ST00120); height-adjustable telescopic brass column; 1-function hand shower in c.p. abs (191HR); 150 cm flexible hose.

273T3A05 Ø 20cm

273T3ATX25 Ø 25cm

273T3ATX30 Ø 30cm



273T3A05

CROMOTERAPIA
COLOR THERAPY

SOFFIONI
SHOWER HEAD

BOCCHE
SPOUTS

BOX INCASSO
BUILT-IN BOX

INCASSI
BUILT-IN

TERMOSTATICI
THERMOSTATICS

SET DOCCIA
SHOWER SET

PANNELLI DOCCIA
SHOWER PANELS

COLONNE DOCCIA
SHOWER COLUMNS

SALISCENDI
SLIDING RAILS

DOCCETTE
HAND SHOWERS

SHUOFF

SET PER BORDO VASCA
DECK MOUNTED BATH TUB SET

MISCELATORI TERMOSTATICI A INCASSO EQUILIBRE-Q EQUILIBRE-Q THERMOSTATIC BUILT-IN MIXERS



125Q1

Miscelatore termostatico da incasso con deviatore per vasca-doccia.
Thermostatic built-in single-lever mixer, with diverter for bath-shower.

CR



126Q1

Miscelatore **termostatico** per doccia con deviatore a 2 vie su unica piastra.
Portata a 3 Bar.
Thermostatic built-in shower mixer with 2 ways diverter on single flange.
Flow rate at 3 Bar.

CR



126Q2

Miscelatore **termostatico** per doccia con deviatore a 3 vie su unica piastra.
Portata a 3 Bar.
Thermostatic built-in shower mixer with 3 ways diverter on single flange.
Flow rate at 3 Bar.

CR



126Q4

Miscelatore **termostatico** per doccia con deviatore a 4 vie su unica piastra.
Portata a 3 Bar.
Thermostatic built-in shower mixer with 4 ways diverter on single flange.
Flow rate at 3 Bar.

CR

126Q5

Miscelatore **termostatico** per doccia con deviatore a 5 vie su unica piastra.
Portata a 3 Bar.
Thermostatic built-in shower mixer with 5 ways diverter on single flange.
Flow rate at 3 Bar.

CR



126AV5P2

Miscelatore **termostatico** per doccia con deviatore a 2 posizioni su unica piastra.
Portata a 3 Bar.
Thermostatic built-in shower mixer with 2 positions diverter on single flange.
Flow rate at 3 Bar.

CR



126AV5P3

Miscelatore **termostatico** per doccia con deviatore a 3 vie su unica piastra.
Portata a 3 Bar.
Thermostatic built-in shower mixer with 3 ways diverter on single flange.
Flow rate at 3 Bar.

CR



126AV5P4

Miscelatore **termostatico** per doccia con deviatore a 4 posizioni su unica piastra.
Portata a 3 Bar.
Thermostatic built-in shower mixer with 4 positions diverter on single flange.
Flow rate at 3 Bar.

CR



126AV5P5

Miscelatore **termostatico** per doccia con deviatore a 5 posizioni su unica piastra.
Portata a 3 Bar.
Thermostatic built-in shower mixer with 5 positions diverter on single flange.
Flow rate at 3 Bar.

CR

SET DOCCIA TERMOSTATICI EQUILIBRE-Q CON DEVIATORE AUTOMATICO A 2 VIE EQUILIBRE-Q THERMOSTATIC SHOWER SET WITH 2-WAY AUTOMATIC DIVERTER



Set doccia composto da: miscelatore termostatico a incasso con deviatore (125Q1); soffione ultrapiatto in acciaio INOX lucidato (SQ00420); braccio piatto a parete in ottone 30 cm (BD00930); doccetta rettangolare piatta a 1 funzione, in ottone (191D9); presa acqua con supporto fisso (242PA); flessibile 150 cm.

Shower set including: built-in thermostatic mixer with diverter (125Q1); ultra-flat shower head in polished stainless steel (SQ00420); 30 cm flat brass wall arm (BD00930); 1-function flat rectangular hand shower, in brass (191D9); brass connection pipe with shower holder (242PA); 150 cm flexible hose.

17BPWTQX20 con soffione doccia 20x20 cm.
with shower head 20x20 cm.

17BPWTQX25 con soffione doccia 25x25 cm.
with shower head 25x25 cm.

17BPWTQX30 con soffione doccia 30x30 cm.
with shower head 30x30 cm.



Set doccia composto da: miscelatore termostatico a incasso con deviatore (125Q1); soffione ultrapiatto in acciaio INOX lucidato (SQ00420); braccio piatto a parete in ottone 30 cm (BD00930); saliscendi piatto in ottone; doccetta rettangolare piatta a 1 funzione, in ottone (191D9); presa acqua a muro (752PA); flessibile 150 cm.

Shower set including: built-in thermostatic mixer with diverter (125Q1); ultra-flat shower head in polished stainless steel (SQ00420); 30 cm flat brass wall arm (BD00930); ultra-flat brass sliding rail; 1-function flat rectangular hand shower, in brass (191D9); wall connection pipe (752PA); 150 cm flexible hose.

17APWTQX20 con soffione doccia 20x20 cm.
with shower head 20x20 cm.

17APWTQX25 con soffione doccia 25x25 cm.
with shower head 25x25 cm.

17APWTQX30 con soffione doccia 30x30 cm.
with shower head 30x30 cm.



17BPWTSR002

Set doccia composto da: miscelatore termostatico a incasso con deviatore (125Q1); soffione a parete 50x20 cm con getto a pioggia, in acciaio INOX lucidato (SR002); doccetta rettangolare piatta a 1 funzione, in ottone (191D9); presa acqua con supporto fisso (242PA); flessibile 150 cm.

Shower set including: built-in thermostatic mixer with diverter (125Q1); 50x20 cm wall shower head with rain jet, in polished stainless steel (SR002); 1-function flat rectangular hand shower, in brass (191D9); brass connection pipe with shower holder (242PA); 150 cm flexible hose.

CR



17APWTSR002

Set doccia composto da: miscelatore termostatico a incasso con deviatore (125Q1); soffione a parete 50x20 cm con getto a pioggia, in acciaio INOX lucidato (SR002); saliscendi piatto in ottone; doccetta rettangolare piatta a 1 funzione, in ottone (191D9); presa acqua a muro (752PA); flessibile 150 cm.

Shower set including: built-in thermostatic mixer with diverter (125Q1); 50x20 cm wall shower head with rain jet, in polished stainless steel (SR002); ultra-flat brass sliding rail; 1-function flat rectangular hand shower, in brass (191D9); wall connection pipe (752PA); 150 cm flexible hose.

CR

17BPWTSR004

Come 17BPWTSR002:
As 17BPWTSR002:

con soffione a parete ultrapiatto, getto a pioggia, in acciaio INOX lucidato (SR004);
with ultra-flat wall shower head with rain jet, in polished stainless steel (SR004);

CR

17APWTSR004

Come 17APWTSR002:
As 17APWTSR002:

con soffione a parete ultrapiatto, getto a pioggia, in acciaio INOX lucidato (SR004);
ultra-flat wall shower head with rain jet, in polished stainless steel (SR004);

CR

CROMOTERAPIA
COLOR THERAPY

SOFFIONI
SHOWER HEAD

BOCCHE
SPOUTS

BOX INCASSO
BUILT-IN BOX

INCASSI
BUILT-IN

TERMOSTATICI
THERMOSTATICS

SET DOCCIA
SHOWER SET

PANNELLI DOCCIA
SHOWER PANELS

COLONNE DOCCIA
SHOWER COLUMNS

SALISCENDI
SLIDING RAILS

DOCCETTE
HAND SHOWERS

SHUFOFF

SET PER BORDO VASCA
DECK MOUNTED BATH TUB SET



17BPWTSR002

SET DOCCIA TERMOSTATICI EQUILIBRE-Q CON DEVIATORE MECCANICO A 2 VIE EQUILIBRE-Q THERMOSTATIC SHOWER SET WITH 2-WAY MECHANICAL DIVERTER



17BPWTP2SR002

Set doccia composto da: miscelatore termostatico a incasso con deviatore a 2 vie su piastra unica (126Q1); soffione a parete 50x20 cm con getto a pioggia, in acciaio INOX lucidato (SR002); doccetta rettangolare piatta a 1 funzione, in ottone (191D9); presa acqua con supporto fisso (242PA); flessibile 150 cm.

Shower set including: built-in thermostatic mixer with 2-way diverter on a single plate (126Q1); 50x20 cm wall shower head with rain jet, in polished stainless steel (SR002); 1-function flat rectangular hand shower, in brass (191D9); brass connection pipe with shower holder (242PA); 150 cm flexible hose.

CR



17APWTP2SR002

Set doccia composto da: miscelatore termostatico a incasso con deviatore a 2 vie su piastra unica (126Q1); soffione a parete 50x20 cm con getto a pioggia, in acciaio INOX lucidato (SR002); saliscendi piatto in ottone; doccetta rettangolare piatta a 1 funzione, in ottone (191D9); presa acqua a muro (752PA); flessibile 150 cm.

Shower set including: built-in thermostatic mixer with 2-way diverter on a single plate (126Q1); 50x20 cm wall shower head with rain jet, in polished stainless steel (SR002); ultra-flat brass sliding rail; 1-function flat rectangular hand shower, in brass (191D9); wall connection pipe (752PA); 150 cm flexible hose.

CR



17BPWTP2SR004

Come 17BPWTP2SR002:
As 17BPWTP2SR002:

con soffione a parete ultrapiatto, getto a pioggia, in acciaio INOX lucidato (SR004);
with ultra-flat wall shower head with rain jet, in polished stainless steel (SR004);

CR



17APWTP2SR004

Come 17APWTP2SR002:
As 17APWTP2SR002:

con soffione a parete ultrapiatto, getto a pioggia, in acciaio INOX lucidato (SR004);
with ultra-flat wall shower head with rain jet, in polished stainless steel (SR004);

CR



17BPWTP2QX20

con soffione doccia 20x20 cm.
with shower head 20x20 cm.

17BPWTP2QX25

con soffione doccia 25x25 cm.
with shower head 25x25 cm.

17BPWTP2QX30

con soffione doccia 30x30 cm.
with shower head 30x30 cm.



17APWTP2QX20

con soffione doccia 20x20 cm.
with shower head 20x20 cm.

17APWTP2QX25

con soffione doccia 25x25 cm.
with shower head 25x25 cm.

17APWTP2QX30

con soffione doccia 30x30 cm.
with shower head 30x30 cm.

CROMOTERAPIA
COLOR THERAPYSOFFIONI
SHOWER HEADBOCCHE
SPOUTSBOX INCASSO
BUILT-IN BOXINCASSI
BUILT-INTERMOSTATICI
THERMOSTATICSSET DOCCIA
SHOWER SETPANNELLI DOCCIA
SHOWER PANELSCOLONNE DOCCIA
SHOWER COLUMNSSALISCENDI
SLIDING RAILSDOCCETTE
HAND SHOWERS

SHUOFF

SET PER BORDO VASCA
DECK MOUNTED BATH TUB SET

SET DOCCIA TERMOSTATICI EQUILIBRE-Q
 CON DEVIATORE A 3 VIE
 EQUILIBRE-Q THERMOSTATIC SHOWER SET
 WITH 3-WAY DIVERTER



17BPWTP3SR003

Set doccia composto da: miscelatore termostatico a incasso con deviatore a 3 vie su unica piastra (126Q2); soffione a parete 50x20 cm con 2 uscite: pioggia e cascata, in acciaio INOX lucidato (SR003); doccetta rettangolare piatta a 1 funzione, in ottone (191D9); presa acqua con supporto fisso (242PA); flessibile 150 cm.

Shower set including: built-in thermostatic mixer with 3-way diverter on a single plate (126Q2); 50x20 cm wall shower head with 2 outlets: rain and waterfall, in polished stainless steel (SR003); 1-function flat rectangular hand shower, in brass (191D9); brass connection pipe with shower holder (242PA); 150 cm flexible hose.



CR



17APWTP3SR003

Set doccia composto da: miscelatore termostatico a incasso con deviatore a 3 vie su unica piastra (126Q2); soffione a parete 50x20 cm con 2 uscite: pioggia e cascata, in acciaio INOX lucidato (SR003); saliscendi piatto in ottone; doccetta rettangolare piatta a 1 funzione, in ottone (191D9); presa acqua a muro (752PA); flessibile 150 cm.

Shower set including: built-in thermostatic mixer with 3-way diverter on a single plate (126Q2); 50x20 cm wall shower head with 2 outlets: rain and waterfall, in polished stainless steel (SR003); ultra-flat brass sliding rail; 1-function flat rectangular hand shower, in brass (191D9); wall connection pipe (752PA); 150 cm flexible hose



CR



17BPWTP3SR005

Come 17BPWTP3SR003:
 As 17BPWTP3SR003:

con soffione a parete 50x22 cm ultrapiatto con 2 uscite: pioggia e cascata, in acciaio INOX lucidato (SR005).
 with 50x22 cm ultra-flat wall shower head with 2 outlets: rain and waterfall, in polished stainless steel (SR005).

CR



17APWTP3SR005

Come 17APWTP3SR003:
 As 17APWTP3SR003:

con soffione a parete 50x22 cm ultrapiatto con 2 uscite: pioggia e cascata, in acciaio INOX lucidato (SR005).
 with 50x22 cm ultra-flat wall shower head with 2 outlets: rain and waterfall, in polished stainless steel (SR005).

CR



EQUILIBRE-Q

La collezione EQUILIBRE-Q, progettata e realizzata da Rubinetterie Mariani, si compone di soluzioni con miscelazione termostatica. Un comfort dedicato agli ambienti vasca e doccia per impostare la temperatura desiderata dell'acqua prima della sua apertura e per mantenerla costante durante tutto l'utilizzo.

Il contenuto tecnologico di EQUILIBRE-Q si inserisce all'interno di un design dalle forme squadrate, utilizzabile con successo in progetti dal gusto spiccatamente moderno.



274TQA

Termostatico quadrato doppia uscita, inferiore 1/2", superiore 3/4" con deviatore integrato nella maniglia, con maniglie in ABS.
Squared thermostatic mixer with double outlet, 1/2" lower connection, 3/4" upper connection, with diverter integrated in the handle, with ABS handles.

CR

The EQUILIBRE-Q collection, engineered and designed by Rubinetterie Mariani, consists of solutions with thermostatic mixing. A comfort dedicated to the bath and shower designs to set the desired water temperature before opening it and to keep it constant throughout use.

The technological content of EQUILIBRE-Q fits within a squared shaped design, which can be successfully used in all projects with a distinctly modern taste.



274TQB

Termostatico quadrato doppia uscita, inferiore 1/2", superiore 3/4" con deviatore integrato nella maniglia, con maniglie in ottone.
Squared thermostatic mixer with double outlet, 1/2" lower connection, 3/4" upper connection, with diverter integrated in the handle, with brass handles.

CR

CROMOTERAPIA
COLOR THERAPY

SOFFIONI
SHOWER HEAD

BOCCHE
SPOUTS

BOX INCASSO
BUILT-IN BOX

INCASSI
BUILT-IN

TERMOSTATICI
THERMOSTATICS

SET DOCCIA
SHOWER SET

PANNELLI DOCCIA
SHOWER PANELS

COLONNE DOCCIA
SHOWER COLUMNS

SAISCENDI
SLIDING RAILS

DOCCETTE
HAND SHOWERS

SHUOFF

SET PER BORDO VASCA
DECK MOUNTED BATH TUB SET



274TQASQA20

COLONNE DOCCIA TERMOSTATICHE EQUILIBRE-Q EQUILIBRE-Q THERMOSTATIC SHOWER COLUMNS

CON OPZIONI DI FINITURA
WITH FINISHING OPTIONS

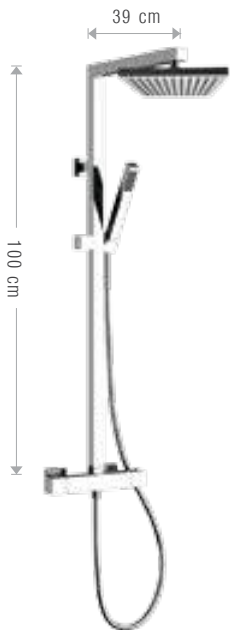

Colonna doccia composta da: miscelatore termostatico esterno con doppio attacco e deviatore integrato (274TQA); soffione in abs cromato (SQA0120); colonna squadrata in ottone; doccetta a 1 funzione in abs cromato (191QD); flessibile 150 cm.

Shower column including: exposed thermostatic mixer with double connection and diverter (274TQA); shower head in c.p. abs (SQA0120); brass squared column; 1-function hand shower in c.p. abs (191QD); 150 cm flexible hose.

274TQASQA20 20x20cm

274TQASQA25 25x25cm

274TQASQA30 30x30cm



274TQBSQB20

Colonna doccia composta da: miscelatore termostatico esterno con doppio attacco e deviatore integrato, maniglie in ottone (274TQB); soffione 20x20 cm in ottone cromato (SQB0120); colonna squadrata in ottone; doccetta minimale quadrata a 1 funzione, in ottone (191PF); flessibile 150 cm.

Shower column including: exposed thermostatic mixer with double connection and diverter, brass handles (274TQB); 20x20 cm shower head in c.p. brass (SQB0120); brass squared column; 1-function squared hand shower, in brass (191PF); 150 cm flexible hose.

CR

FIN (.14 .37 .08)

CROMOTERAPIA
COLOR THERAPYSOFFIONI
SHOWER HEADBOCCHE
SPOUTSBOX INCASSO
BUILT-IN BOXINCASSI
BUILT-INTERMOSTATICI
THERMOSTATICSSET DOCCIA
SHOWER SETPANNELLI DOCCIA
SHOWER PANELSCOLONNE DOCCIA
SHOWER COLUMNSSALISCENDI
SLIDING RAILSDOCCETTE
HAND SHOWERS

SHUFOFF

SET PER BORDO VASCA
DECK MOUNTED BATH TUB SET





SET DOCCIA SHOWER SET

CROMOTERAPIA
COLOR THERAPY

SOFFIONI
SHOWER HEAD

BOCCHE
SPOUTS

BOX INCASSO
BUILT-IN BOX

INCASSI
BUILT-IN

TERMOSTATICI
THERMOSTATICS

SET DOCCIA
SHOWER SET

PANNELLI DOCCIA
SHOWER PANELS

COLONNE DOCCIA
SHOWER COLUMNS

SAISCENDI
SLIDING RAILS

DOCCETTE
HAND SHOWERS

SHUFOFF

SET PER BORDO VASCA
DECK MOUNTED BATH TUB SET

SET DOCCIA A 2 VIE CON DEVIATORE AUTOMATICO QUADRATO SQUARED 2-WAY SHOWER SET WITH AUTOMATIC DIVERTER



Set doccia composto da: miscelatore a incasso con deviatore (173PA); soffione in abs cromato (SQA0120); braccio a parete 30 cm in ottone, forma squadrata (BD00430); doccetta a 1 funzione in abs cromato (191QD); presa acqua con supporto fisso (242PA); flessibile 150 cm.

Shower set including: built-in mixer with diverter (173PA); shower head in c.p. abs (SQA0120); 30 cm brass shower arm, squared shape (BD00430); 1-function hand shower in c.p. abs (191QD); brass connection pipe with shower holder (242PA); 150 cm flexible hose.

17BPWQA20 con soffione doccia 20x20 cm.
with shower head 20x20 cm.

17BPWQA25 con soffione doccia 25x25 cm.
with shower head 25x25 cm.

17BPWQA30 con soffione doccia 30x30 cm.
with shower head 30x30 cm.



Set doccia composto da: miscelatore a incasso con deviatore (173PA); soffione in abs cromato (SQA0120); braccio a parete 30 cm in ottone, forma squadrata (BD00430); saliscendi squadrato in ottone; doccetta a 1 funzione in abs cromato (191QD); presa acqua a muro (752PA); flessibile 150 cm.

Shower set including: built-in mixer with diverter (173PA); shower head in c.p. abs (SQA0120); 30 cm brass shower arm, squared shape (BD00430); squared brass sliding rail; 1-function hand shower in c.p. abs (191QD); wall connection pipe (752PA); 150 cm flexible hose.

17APWQA20 con soffione doccia 20x20 cm.
with shower head 20x20 cm.

17APWQA25 con soffione doccia 25x25 cm.
with shower head 25x25 cm.

17APWQA30 con soffione doccia 30x30 cm.
with shower head 30x30 cm.



Set doccia composto da: miscelatore a incasso con deviatore (173PA); soffione ultrapiatto in acciaio INOX lucidato (SQ00420); braccio a parete 30 cm in ottone, forma squadrata (BD00430); doccetta rettangolare piatta a 1 funzione, in ottone (191D9); presa acqua con supporto fisso (242PA); flessibile 150 cm.

Shower set including: built-in mixer with diverter (173PA); ultra-flat shower head in polished stainless steel (SQ00420); 30 cm brass shower arm, squared shape (BD00430); 1-function flat rectangular hand shower, in brass (191D9); brass connection pipe with shower holder (242PA); 150 cm flexible hose.

17BPWQX20 con soffione doccia 20x20 cm.
with shower head 20x20 cm.

17BPWQX25 con soffione doccia 25x25 cm.
with shower head 25x25 cm.

17BPWQX30 con soffione doccia 30x30 cm.
with shower head 30x30 cm.



Set doccia composto da: miscelatore a incasso con deviatore (173PA); soffione ultrapiatto in acciaio INOX lucidato (SQ00420); braccio a parete 30 cm in ottone, forma squadrata (BD00430); saliscendi piatto in ottone; doccetta rettangolare piatta a 1 funzione, in ottone (191D9); presa acqua a muro (752PA); flessibile 150 cm.

Shower set including: built-in mixer with diverter (173PA); ultra-flat shower head in polished stainless steel (SQ00420); 30 cm brass shower arm, squared shape (BD00430); ultra-flat brass sliding rail; 1-function flat rectangular hand shower, in brass (191D9); wall connection pipe (752PA); 150 cm flexible hose.

17APWQX20 con soffione doccia 20x20 cm.
with shower head 20x20 cm.

17APWQX25 con soffione doccia 25x25 cm.
with shower head 25x25 cm.

17APWQX30 con soffione doccia 30x30 cm.
with shower head 30x30 cm.

CON OPZIONI DI FINITURA – WITH FINISHING OPTIONS

**17BPWQB20**

Set doccia composto da: miscelatore a incasso con deviatore (173PA); soffione 20x20 cm in ottone cromato (SQB0120); braccio a parete 30 cm in ottone, forma squadrata (BD00430); doccetta minimale quadrata a 1 funzione, in ottone (191PF); presa acqua con supporto fisso (242PA); flessibile 150 cm.

Shower set including: built-in mixer with diverter (173PA); 20x20 cm shower head in c.p. brass (SQB0120); 30 cm brass shower arm, squared shape (BD00430); 1-function squared hand shower, in brass (191PF); brass connection pipe with shower holder (242PA); 150 cm flexible hose.

CR

FIN (.14.37.08)

**17APWQB20**

Set doccia composto da: miscelatore a incasso con deviatore (173PA); soffione 20x20 cm in ottone cromato (SQB0120); braccio a parete 30 cm in ottone, forma squadrata (BD00430); saliscendi squadrato in ottone; doccetta minimale quadrata a 1 funzione, in ottone (191PF); presa acqua a muro (752PA); flessibile 150 cm.

Shower set including: built-in mixer with diverter (173PA); 20x20 cm shower head in c.p. brass (SQB0120); 30 cm brass shower arm, squared shape (BD00430); squared brass sliding rail; 1-function squared hand shower, in brass (191PF); wall connection pipe (752PA); 150 cm flexible hose.

CR

FIN (.14.37.08)



17BPWQB20

CROMOTERAPIA
COLOR THERAPYSOFFIONI
SHOWER HEADBOCCHE
SPOUTSBOX INCASSO
BUILT-IN BOXINCASSI
BUILT-INTHERMOSTATICI
THERMOSTATICSSET DOCCIA
SHOWER SETPANNELLI DOCCIA
SHOWER PANELSCOLONNE DOCCIA
SHOWER COLUMNSSALISCENDI
SLIDING RAILSDOCCETTE
HAND SHOWERS

SHUOFFO

SET PER BORDO VASCA
DECK MOUNTED BATH TUB SET

SET DOCCIA A 2 VIE CON DEVIATORE MECCANICO QUADRATO SQUARED 2-WAY SHOWER SET WITH MECHANICAL DIVERTER



Set doccia composto da: miscelatore a incasso con deviatore a 2 vie su unica piastra (173PAP2); soffione in abs cromato (SQA0120); braccio a parete 30 cm in ottone, forma squadrata (BD00430); doccetta a 1 funzione in abs cromato (191QD); presa acqua con supporto fisso (242PA); flessibile 150 cm. Shower set including: built-in mixer with 2-way diverter on a single plate (173PAP2); shower head in c.p. abs (SQA0120); 30 cm brass shower arm, squared shape (BD00430); 1-function hand shower in c.p. abs (191QD); brass connection pipe with shower holder (242PA); 150 cm flexible hose.

17BPWP2QA20 con soffione doccia 20x20 cm.
with shower head 20x20 cm.

17BPWP2QA25 con soffione doccia 25x25 cm.
with shower head 25x25 cm.

17BPWP2QA30 con soffione doccia 30x30 cm.
with shower head 30x30 cm.



Set doccia composto da: miscelatore a incasso con deviatore a 2 vie su unica piastra (173PAP2); soffione in abs cromato (SQA0120); braccio a parete 30 cm in ottone, forma squadrata (BD00430); saliscendi squadrato in ottone; doccetta a 1 funzione in abs cromato (191QD); presa acqua a muro (752PA); flessibile 150 cm.

Shower set including: built-in mixer with 2-way diverter on a single plate (173PAP2); shower head in c.p. abs (SQA0120); 30 cm brass shower arm, squared shape (BD00430); squared brass sliding rail; 1-function hand shower in c.p. abs (191QD); wall connection pipe (752PA); 150 cm flexible hose.

17APWP2QA20 con soffione doccia 20x20 cm.
with shower head 20x20 cm.

17APWP2QA25 con soffione doccia 25x25 cm.
with shower head 25x25 cm.

17APWP2QA30 con soffione doccia 30x30 cm.
with shower head 30x30 cm.



Set doccia composto da: miscelatore a incasso con deviatore a 2 vie su unica piastra (173PAP2); soffione ultrapiatto 20x20 cm in acciaio INOX lucidato (SQ00420); braccio a parete 30 cm in ottone, forma squadrata (BD00430); doccetta rettangolare piatta a 1 funzione, in ottone (191D9); presa acqua con supporto fisso (242PA); flessibile 150 cm.

Shower set including: built-in mixer with 2-way diverter on a single plate (173PAP2); 20x20 cm ultra-flat shower head in polished stainless steel (SQ00420); 30 cm brass shower arm, squared shape (BD00430); 1-function flat rectangular hand shower, in brass (191D9); brass connection pipe with shower holder (242PA); 150 cm flexible hose.

17BPWP2QX20 con soffione doccia 20x20 cm.
with shower head 20x20 cm.

17BPWP2QX25 con soffione doccia 25x25 cm.
with shower head 25x25 cm.

17BPWP2QX30 con soffione doccia 30x30 cm.
with shower head 30x30 cm.



Set doccia composto da: miscelatore a incasso con deviatore a 2 vie su unica piastra (173PAP2); soffione ultrapiatto in acciaio INOX lucidato (SQ00420); braccio a parete 30 cm in ottone, forma squadrata (BD00430); saliscendi piatto in ottone; doccetta rettangolare piatta a 1 funzione, in ottone (191D9); presa acqua a muro (752PA); flessibile 150 cm.

Shower set including: built-in mixer with 2-way diverter on a single plate (173PAP2); ultra-flat shower head in polished stainless steel (SQ00420); 30 cm brass shower arm, squared shape (BD00430); ultra-flat brass sliding rail; 1-function flat rectangular hand shower, in brass (191D9); wall connection pipe (752PA); 150 cm flexible hose.

17APWP2QX20 con soffione doccia 20x20 cm.
with shower head 20x20 cm.

17APWP2QX25 con soffione doccia 25x25 cm.
with shower head 25x25 cm.

17APWP2QX30 con soffione doccia 30x30 cm.
with shower head 30x30 cm.

CON OPZIONI DI FINITURA – WITH FINISHING OPTIONS

**17BPWP2QB20**

Set doccia composto da: miscelatore a incasso con deviatore a 2 vie su unica piastra (173PAP2); soffione in ottone cromato (SQB0120); braccio a parete 30 cm in ottone, forma squadrata (BD00430); doccetta minimale quadrata a 1 funzione, in ottone (191PF); presa acqua con supporto fisso (242PA); flessibile 150 cm.

Shower set including: built-in mixer with 2-way diverter on a single plate (173PAP2); shower head in c.p. brass (SQB0120); 30 cm brass shower arm, squared shape (BD00430); 1-function squared hand shower, in brass (191PF); brass connection pipe with shower holder (242PA); 150 cm flexible hose.

CR

FIN (.14.37.08)

**17APWP2QB20**

Set doccia composto da: miscelatore a incasso con deviatore a 2 vie su unica piastra (173PAP2); soffione in ottone cromato (SQB0120); braccio a parete 40 cm in ottone, forma squadrata (BD00440); saliscendi quadrato in ottone; doccetta minimale quadrata a 1 funzione, in ottone (191PF); presa acqua a muro (752PA); flessibile 150 cm.

Shower set including: built-in mixer with 2-way diverter on a single plate (173PAP2); shower head in c.p. brass (SQB0120); 40 cm brass shower arm, squared shape (BD00440); squared brass sliding rail; 1-function squared hand shower, in brass (191PF); wall connection pipe (752PA); 150 cm flexible hose.

CR

FIN (.14.37.08)



17APWP2QB20

CROMOTERAPIA
COLOR THERAPYSOFFIONI
SHOWER HEADBOCCHE
SPOUTSBOX INCASSO
BUILT-IN BOXINCASSI
BUILT-INTHERMOSTATICI
THERMOSTATICSSET DOCCIA
SHOWER SETPANNELLI DOCCIA
SHOWER PANELSCOLONNE DOCCIA
SHOWER COLUMNSSALISCENDI
SLIDING RAILSDOCCETTE
HAND SHOWERS

SHU-OFF

SET PER BORDO VASCA
DECK MOUNTED BATH TUB SET

SET DOCCIA DESIGN A 2 VIE SQUADRATO SQUARED 2-WAY DESIGN SHOWER SET



17BPWSR002

Set doccia composto da: miscelatore a incasso con deviatore (173PA); soffione a parete 50x20 cm con getto a pioggia, in acciaio INOX lucidato (SR002); doccetta rettangolare piatta a 1 funzione, in ottone (191D9); presa acqua con supporto fisso (242PA); flessibile 150 cm.

Shower set including: built-in mixer with diverter (173PA); 50x20 cm wall shower head with rain jet, in polished stainless steel (SR002); 1-function flat rectangular hand shower, in brass (191D9); brass connection pipe with shower holder (242PA); 150 cm flexible hose.



CR



17APWSR002

Set doccia composto da: miscelatore a incasso con deviatore (173PA); soffione a parete 50x20 cm con getto a pioggia, in acciaio INOX lucidato (SR002); saliscendi piatto in ottone; doccetta rettangolare piatta a 1 funzione, in ottone (191D9); presa acqua a muro (752PA); flessibile 150 cm.

Shower set including: built-in mixer with diverter (173PA); 50x20 cm wall shower head with rain jet, in polished stainless steel (SR002); ultra-flat brass sliding rail; 1-function flat rectangular hand shower, in brass (191D9); wall connection pipe (752PA); 150 cm flexible hose.



CR



17BPWSR004

Come 17BPWSR002:
As 17BPWSR002:

con soffione a parete ultrapiatto, getto a pioggia, in acciaio INOX lucidato (SR004);

ultra-flat wall shower head with rain jet, in polished stainless steel (SR004);

CR



17APWSR004

Come 17AAV5P3SR003:
As 17AAV5P3SR003:

con soffione a parete ultrapiatto, getto a pioggia, in acciaio INOX lucidato (SR004).

with ultra-flat wall shower head with rain jet, in polished stainless steel (SR004).

CR



17BPWP2SR002

Set doccia composto da: miscelatore a incasso con deviatore a 2 vie su unica piastra (173PAP2); soffione a parete 50x20 cm con getto a pioggia, in acciaio INOX lucidato (SR002); doccetta rettangolare piatta a 1 funzione, in ottone (191D9); presa acqua con supporto fisso (242PA); flessibile 150 cm.

Shower set including: built-in mixer with 2-way diverter on a single plate (173PAP2); 50x20 cm wall shower head with rain jet, in polished stainless steel (SR002); 1-function flat rectangular hand shower, in brass (191D9); brass connection pipe with shower holder (242PA); 150 cm flexible hose.



CR



17APWP2SR002

Set doccia composto da: miscelatore a incasso con deviatore a 2 vie su unica piastra (173PAP2); soffione a parete 50x20 cm con getto a pioggia, in acciaio INOX lucidato (SR002); saliscendi piatto in ottone; doccetta rettangolare piatta a 1 funzione, in ottone (191D9); presa acqua a muro (752PA); flessibile 150 cm.

Shower set including: built-in mixer with 2-way diverter on a single plate (173PAP2); 50x20 cm wall shower head with rain jet, in polished stainless steel (SR002); ultra-flat brass sliding rail; 1-function flat rectangular hand shower, in brass (191D9); wall connection pipe (752PA); 150 cm flexible hose.



CR



17BPWP2SR004

Come 17BPWP2SR002:
As 17BPWP2SR002:

soffione a parete ultrapiatto, getto a pioggia, in acciaio INOX lucidato (SR004);

ultra-flat wall shower head with rain jet, in polished stainless steel (SR004);

CR



17APWP2SR004

Come 17APWP2SR002:
As 17APWP2SR002:

soffione a parete ultrapiatto, getto a pioggia, in acciaio INOX lucidato (SR004);

ultra-flat wall shower head with rain jet, in polished stainless steel (SR004);

CR



CROMOTERAPIA
COLOR THERAPY

SOFFIONI
SHOWER HEAD

BOCCHE
SPOUTS

BOX INCASSO
BUILT-IN BOX

INCASSI
BUILT-IN

TERMOSTATICI
THERMOSTATICS

SET DOCCIA
SHOWER SET

PANNELLI DOCCIA
SHOWER PANELS

COLONNE DOCCIA
SHOWER COLUMNS

SLISCENDI
SLIDING RAILS

DOCCETTE
HAND SHOWERS

SHUFOFF

SET PER BORDO VASCA
DECK MOUNTED BATH TUB SET

17APWSR002

SET DOCCIA DESIGN A 3 VIE QUADRATO SQUARED 3-WAY DESIGN SHOWER SET



17BPWP3SR003

Set doccia composto da: miscelatore a incasso con deviatore a 3 vie su unica piastra. (173PAP3); soffione a parete 50x20 cm con 2 uscite: pioggia e cascata, in acciaio INOX lucidato (SR003); doccetta rettangolare piatta a 1 funzione, in ottone (191D9); presa acqua con supporto fisso (242PA); flessibile 150 cm.

Shower set including: built-in mixer with 3-way diverter on a single plate (173PAP3); 50x20 cm wall shower head with 2 outlets: rain and waterfall, in polished stainless steel (SR003); 1-function flat rectangular hand shower, in brass (191D9); brass connection pipe with shower holder (242PA); 150 cm flexible hose.

CR



17APWP3SR003

Set doccia composto da: miscelatore a incasso con deviatore a 3 vie su unica piastra. (173PAP3); soffione a parete 50x20 cm con 2 uscite: pioggia e cascata, in acciaio INOX lucidato (SR003); saliscendi piatto in ottone; doccetta rettangolare piatta a 1 funzione, in ottone (191D9); presa acqua a muro (752PA); flessibile 150 cm.

Shower set including: built-in mixer with 3-way diverter on a single plate (173PAP3); 50x20 cm wall shower head with 2 outlets: rain and waterfall, in polished stainless steel (SR003); ultra-flat brass sliding rail; 1-function flat rectangular hand shower, in brass (191D9); wall connection pipe (752PA); 150 cm flexible hose.

CR



17BPWP3SR005

Come 17BPWP3SR003:
As 17BPWP3SR003:

con soffione a parete 50x22 cm ultrapiatto con 2 uscite: pioggia e cascata, in acciaio INOX lucidato (SR005).

with wall stainless steel ultra-flat shower head 50x25 cm, 2 jets: waterfall and rain.

CR



17APWP3SR005

Come 17APWP3SR003:
As 17APWP3SR003:

con soffione a parete 50x22 cm ultrapiatto con 2 uscite: pioggia e cascata, in acciaio INOX lucidato (SR005).

with 50x22 cm ultra-flat wall shower head with 2 outlets: rain and waterfall, in polished stainless steel (SR005).

CR

SET DOCCIA DESIGN A 4 VIE QUADRATO SQUARED 4-WAY DESIGN SHOWER SET



17BPWP4

Set doccia composto da: miscelatore a incasso con deviatore a 4 vie su unica piastra (173PAP4); soffione a soffitto 43x43 cm a 2 funzioni: getto a pioggia e cascata, in acciaio INOX lucidato (SSQ43C); doccetta rettangolare piatta a 1 funzione, in ottone (191D9); presa acqua con supporto fisso (242PA); 6 getti a muro in ottone orientabili (GQ001); flessibile 150 cm.

Shower set including: built-in mixer with 4-way diverter on single plate (173PAP4); 43x43 cm ceiling shower head with 2 functions: rain and waterfall jet, in polished stainless steel (SSQ43C); 1-function flat rectangular hand shower, in brass (191D9); brass connection pipe with shower holder (242PA); 6 adjustable brass wall jets (GQ001); 150 cm flexible hose.

CR



17APWP4

Set doccia composto da: miscelatore a incasso con deviatore a 4 vie su unica piastra (173PAP4); soffione a soffitto 70x40 cm a 2 funzioni: getto pioggia (2 postazioni) e getto a cascata centrale, in acciaio INOX lucidato (SSR70C); saliscendi piatto in ottone; doccetta rettangolare piatta a 1 funzione, in ottone (191D9); presa acqua a muro (752PA); 6 getti a muro in ottone orientabili (GQ001); flessibile 150 cm.

Shower set including: built-in mixer with 4-way diverter on single plate (173PAP4); 70x40 cm ceiling shower head with 2 functions: rain jet (2 stations) and central waterfall jet, in polished stainless steel (SSR70C); ultra-flat brass sliding rail; 1-function flat rectangular hand shower, in brass (191D9); wall connection pipe (752PA); 6 adjustable brass wall jets (GQ001); 150 cm flexible hose.

CR

SET DOCCIA DESIGN A 5 VIE QUADRATO SQUARED 5-WAY DESIGN SHOWER SET



17BPWP5

Set doccia composto da: miscelatore a incasso con deviatore a 5 vie su unica piastra (173PAP5); soffione a soffitto 43x43 cm a 3 funzioni: getto a pioggia, nebulizzazione (4 uscite) ed 1 getto a cascata, in acciaio INOX lucidato (SSQ43NC); doccetta rettangolare piatta a 1 funzione, in ottone (191D9); presa acqua con supporto fisso (242PA); 6 getti a muro in ottone orientabili (GQ001); flessibile 150 cm.

Shower set including: built-in mixer with 5-way diverter on a single plate (173PAP5); 43x43 cm ceiling shower head with 3 functions: rain jet, nebulization (4 outlets) and 1 waterfall jet, in polished stainless steel (SSQ43NC); 1-function flat rectangular hand shower, in brass (191D9); brass connection pipe with shower holder (242PA); 6 adjustable brass wall jets (GQ001); 150 cm flexible hose.

CR



17APWP5

Set doccia composto da: miscelatore a incasso con deviatore a 5 vie su unica piastra (173PAP5); soffione a soffitto, 70x40 cm a 3 funzioni: getto a pioggia, nebulizzazione (4 uscite) e getto a cascata centrale, in acciaio INOX lucidato (SSR70NC); saliscendi piatto in ottone; doccetta rettangolare piatta a 1 funzione, in ottone (191D9); presa acqua a muro (752PA); 6 getti a muro in ottone orientabili (GQ001); flessibile 150 cm.

Shower set including: built-in mixer with 5-way diverter on a single plate (173PAP5); 70x40 cm ceiling shower head with 3 functions: rain jet, nebulization (4 outlets) and waterfall jet, in polished stainless steel (SSR70NC); ultra-flat brass sliding rail; 1-function flat rectangular hand shower, in brass (191D9); wall connection pipe (752PA); 6 adjustable brass wall jets (GQ001); 150 cm flexible hose.







CR

CROMOTERAPIA
COLOR THERAPYSOFFIONI
SHOWER HEADBOCCHE
SPOUTSBOX INCASSO
BUILT-IN BOXINCASSI
BUILT-INTHERMOSTATICI
THERMOSTATICSSET DOCCIA
SHOWER SETPANNELLI DOCCIA
SHOWER PANELSCOLONNE DOCCIA
SHOWER COLUMNSSALISCENDI
SLIDING RAILSDOCCETTE
HAND SHOWERS

SHUOFFO

SET PER BORDO VASCA
DECK MOUNTED BATH TUB SET

FUNZIONALITA' DI INSTALLAZIONE
INSTALLATION FEATURES

A		Altezza persona Person height	180 cm
B		Soffione Shower head	220 cm
C		Kit doccetta con presa acqua Handshower kit with water inlet	115 cm
D		Getti laterali superiori Upper body spray	150 cm
E		Getti laterali medi Middle body spray	115 cm
F		Getti laterali Inferiori Lower body spray	80 cm
G		Miscelatore Mixer	115 cm

L'altezza ottimale di collocazione dei singoli prodotti si determina in base all'altezza della persona.
Each individual product can be installed and adjusted to suit person's height.

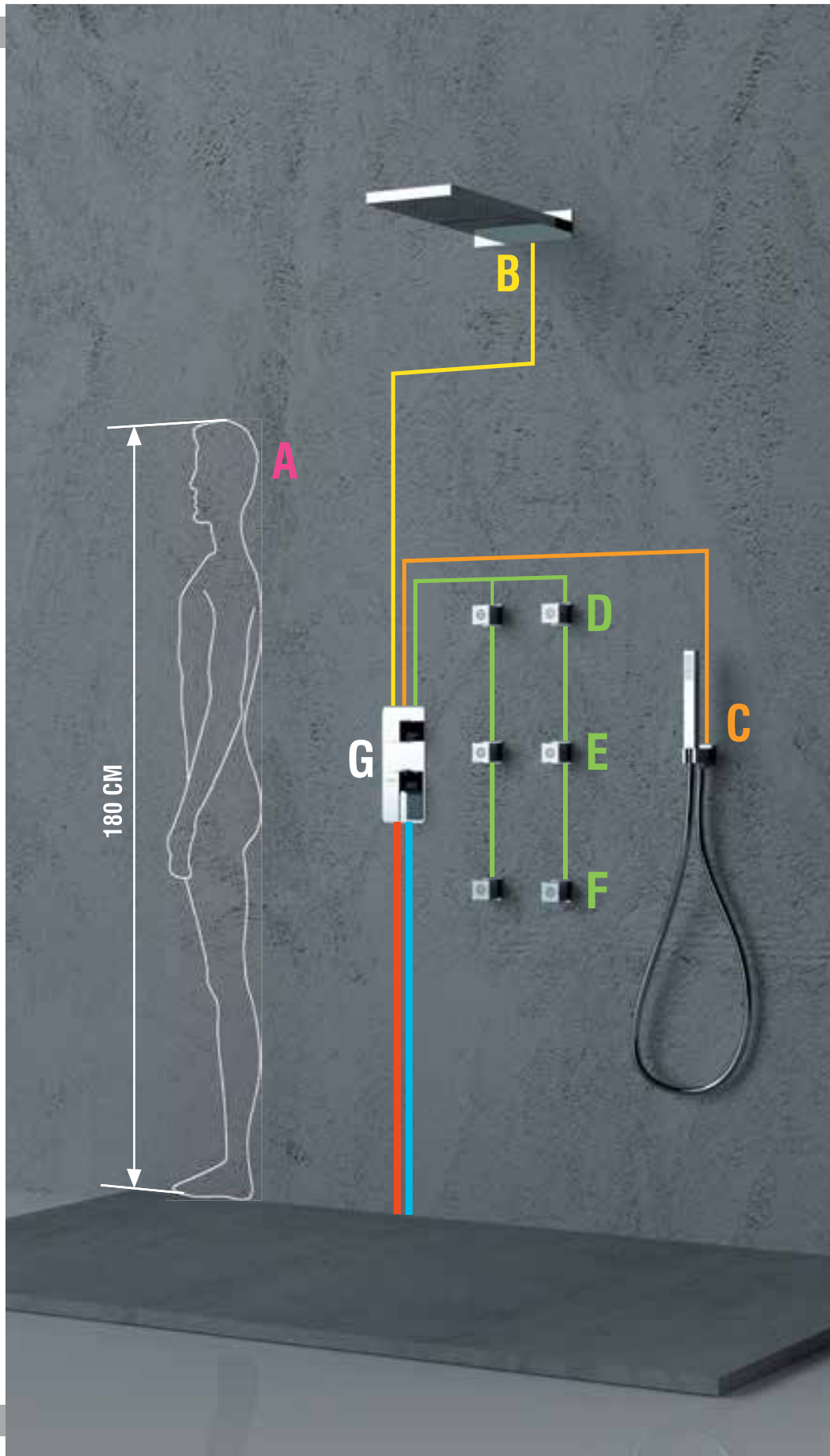

CROMOTERAPIA
COLOR THERAPY

SOFFIONI
SHOWER HEAD

BOCCHE
SPOUTS

BOX INCASSO
BUILT-IN BOX

INCASSI
BUILT-IN

TERMOSTATICI
THERMOSTATICS

SET DOCCIA
SHOWER SET

PANNELLI DOCCIA
SHOWER PANELS

COLONNE DOCCIA
SHOWER COLUMNS

SALISCENDI
SLIDING RAILS

DOCCETTE
HAND SHOWERS

SHUFOFF

SET PER BORDO VASCA
DECK MOUNTED BATH TUB SET

SET DOCCIA A 2 VIE CON DEVIATORE AUTOMATICO TONDO ROUNDED 2-WAY SHOWER SET WITH AUTOMATIC DIVERTER



Set doccia composto da: miscelatore a incasso con deviatore (173UM); soffione in ABS cromato (STA0120); braccio a parete in ottone 30 cm (BDL0530); doccetta a 1 funzione in abs cromato (191HR); presa acqua a muro con supporto fisso (242MN); flessibile 150 cm.

Shower set including: built-in mixer with diverter (173UM); shower head in c.p. abs (STA0120); 30 cm brass wall arm (BDL0530); 1-function hand shower in c.p. abs (191HR); wall connection pipe with shower holder (242MN); 150 cm flexible hose.

17BUWTA20 con soffione doccia Ø20 cm.
with shower head Ø20 cm.

17BUWTA25 con soffione doccia Ø25 cm.
with shower head Ø25 cm.

17BUWTA30 con soffione doccia Ø30 cm.
with shower head Ø30 cm.



Set doccia composto da: miscelatore a incasso con deviatore (173UM); soffione in ABS cromato (STA0120); braccio a parete in ottone 30 cm (BDL0530); asta saliscendi cromata; doccetta a 1 funzione in abs cromato (191HR); presa acqua a muro (752NO); flessibile 150 cm.

Shower set including: built-in mixer with diverter (173UM); shower head in c.p. abs (STA0120); 30 cm brass wall arm (BDL0530); c.p. sliding rail; 1-function hand shower in c.p. abs (191HR); wall connection pipe (752NO); 150 cm flexible hose.

17AUWTA20 con soffione doccia Ø20 cm.
with shower head Ø20 cm.

17AUWTA25 con soffione doccia Ø25 cm.
with shower head Ø25 cm.

17AUWTA30 con soffione doccia Ø30 cm.
with shower head Ø30 cm.



Set doccia composto da: miscelatore a incasso con deviatore (173UM); soffione ultrapiatto, in acciaio INOX lucidato (ST00120); braccio a parete in ottone 30 cm (BD00330); doccetta a 1 funzione in abs cromato (191HR); presa acqua a muro con supporto fisso (242MN); flessibile 150 cm.

Shower set including: built-in mixer with diverter (173UM); ultra-flat shower head in polished stainless steel (ST00120); 30 cm brass wall arm (BD00330); 1-function hand shower in c.p. abs (191HR); wall connection pipe with shower holder (242MN); 150 cm flexible hose.

17BUWTX20 con soffione doccia Ø20 cm.
with shower head Ø20 cm.

17BUWTX25 con soffione doccia Ø25 cm.
with shower head Ø25 cm.

17BUWTX30 con soffione doccia Ø30 cm.
with shower head Ø30 cm.



Set doccia composto da: miscelatore a incasso con deviatore (173UM); soffione ultrapiatto, in acciaio INOX lucidato (ST00120); braccio a parete in ottone 30 cm (BD00330); asta saliscendi cromata; doccetta a 1 funzione in abs cromato (191HR); presa acqua a muro (752NO); flessibile 150 cm.

Shower set including: built-in mixer with diverter (173UM); ultra-flat shower head in polished stainless steel (ST00120); 30 cm brass wall arm (BD00330); 1-function hand shower in c.p. abs (191HR); wall connection pipe with shower holder (242MN); 150 cm flexible hose.

17AUWTX20 con soffione doccia Ø20 cm.
with shower head Ø20 cm.

17AUWTX25 con soffione doccia Ø25 cm.
with shower head Ø25 cm.

17AUWTX30 con soffione doccia Ø30 cm.
with shower head Ø30 cm.

CON OPZIONI DI FINITURA – WITH FINISHING OPTIONS

**17BUWTB20**

Set doccia composto da: miscelatore a incasso con deviatore (173UM); soffione Ø 20 cm in ottone (STB0120); braccio a parete in ottone 30 cm (BD00330); doccetta a 1 funzione in ottone cromato (191D6); presa acqua a muro con supporto fisso (242MN); flessibile 150 cm.

Shower set including: built-in mixer with diverter (173UM); Ø 20 cm brass shower head (STB0120); 30 cm brass wall arm (BD00330); 1-function brass hand shower (191D6); wall connection pipe with shower holder (242MN); 150 cm flexible hose.

CR

FIN (.14.37.08)

**17AUWTB20**

Set doccia composto da: miscelatore a incasso con deviatore (173UM); soffione Ø 20 cm in ottone (STB0120); braccio a parete in ottone 30 cm (BD00330); asta saliscendi in ottone; doccetta a 1 funzione in ottone cromato (191D6); presa acqua a muro (752N0); flessibile 150 cm.

Shower set including: built-in mixer with diverter (173UM); Ø 20 cm brass shower head (STB0120); 30 cm brass wall arm (BD00330); brass sliding rail; 1-function brass hand shower (191D6); wall connection pipe (752N0); 150 cm flexible hose.

CR

FIN (.14.37.08)



17BUWTB20

CROMOTERAPIA
CHROMOTHERAPYSOFFIONI
SHOWER HEADBOCCHE
SPOUTSBOX INCASSO
BUILT-IN BOXINCASSI
BUILT-INTHERMOSTATICI
THERMOSTATICSSET DOCCIA
SHOWER SETPANNELLI DOCCIA
SHOWER PANELSCOLONNE DOCCIA
SHOWER COLUMNSSALISCENDI
SLIDING RAILSDOCCETTE
HAND SHOWERS

SHUFOFF

SET PER BORDO VASCA
DECK MOUNTED BATHTUB SET

SET DOCCIA A 2 VIE CON DEVIATORE MECCANICO TONDO ROUNDED 2-WAY SHOWER SET WITH MECHANICAL DIVERTER



17BUWP2TA20

Set doccia composto da: miscelatore a incasso con deviatore a 2 vie su unica piastra (173UMP2); soffione in ABS cromato (STA0120); braccio a parete in ottone 30 cm (BDL0530); doccetta a 1 funzione in abs cromato (191HR); presa acqua a muro con supporto fisso (242MN); flessibile 150 cm.

Shower set including: built-in mixer with 2-way diverter on single plate (173UMP2); shower head in c.p. abs (STA0120); 30 cm brass wall arm (BDL0530); 1-function hand shower in c.p. abs (191HR); wall connection pipe with shower holder (242MN); 150 cm flexible hose.

17BUWP2TA20 con soffione doccia Ø20 cm.
with shower head Ø20 cm.

17BUWP2TA25 con soffione doccia Ø25 cm.
with shower head Ø25 cm.

17BUWP2TA30 con soffione doccia Ø30 cm.
with shower head Ø30 cm.



17AUWP2TA20

Set doccia composto da: miscelatore a incasso con deviatore a 2 vie su unica piastra (173UMP2); soffione in ABS cromato (STA0120); braccio a parete in ottone 30 cm (BDL0530); asta saliscendi cromata; doccetta a 1 funzione in abs cromato (191HR); presa acqua a muro (752N0); flessibile 150 cm.

Shower set including: built-in mixer with 2-way diverter on single plate (173UMP2); shower head in c.p. abs (STA0120); 30 cm brass wall arm (BDL0530); c.p. sliding rail; 1-function hand shower in c.p. abs (191HR); wall connection pipe (752N0); 150 cm flexible hose.

17AUWP2TA20 con soffione doccia Ø20 cm.
with shower head Ø20 cm.

17AUWP2TA25 con soffione doccia Ø25 cm.
with shower head Ø25 cm.

17AUWP2TA30 con soffione doccia Ø30 cm.
with shower head Ø30 cm.

CON OPZIONI DI FINITURA WITH FINISHING OPTIONS



Set doccia composto da: miscelatore a incasso con deviatore a 2 vie su unica piastra (173UMP2); soffione ultrapiatto, in acciaio INOX lucidato (ST00120); braccio a parete in ottone 30 cm (BD00330); doccetta a 1 funzione in abs cromato (191HR); presa acqua a muro con supporto fisso (242MN); flessibile 150 cm.

Shower set including: built-in mixer with 2-way diverter on single plate (173UMP2); ultra-flat shower head in polished stainless steel (ST00120); 30 cm brass wall arm (BD00330); 1-function hand shower in c.p. abs (191HR); wall connection pipe with shower holder (242MN); 150 cm flexible hose.

17BUWP2TX20 con soffione doccia Ø20 cm.
with shower head Ø20 cm.

17BUWP2TX25 con soffione doccia Ø25 cm.
with shower head Ø25 cm.

17BUWP2TX30 con soffione doccia Ø30 cm.
with shower head Ø30 cm.



Set doccia composto da: miscelatore con deviatore a 2 vie su piastre separate (176UMPP2); soffione ultrapiatto, in acciaio INOX lucidato (ST00120); braccio a parete in ottone 30 cm (BD00330); doccetta a 1 funzione in ottone cromato (191D6); presa acqua a muro con supporto (242MNB); flessibile 150 cm.

Shower set including: shower mixer with 2-way diverter on separate plates (176UMPP2); ultra-flat shower head in polished stainless steel (ST00120); 30 cm brass wall arm (BD00330); 1-function brass hand shower (191D6); wall connection pipe with shower holder (242MNB); 150 cm flexible hose.

17CUMTX20 con soffione doccia Ø20 cm.
with shower head Ø20 cm.

FIN (.14.37.08)

17CUMTX25 con soffione doccia Ø25 cm.
with shower head Ø25 cm.

FIN (.14.37.08)

17CUMTX30 con soffione doccia Ø30 cm.
with shower head Ø30 cm.

FIN (.14.37.08)

CON OPZIONI DI FINITURA
WITH FINISHING OPTIONS

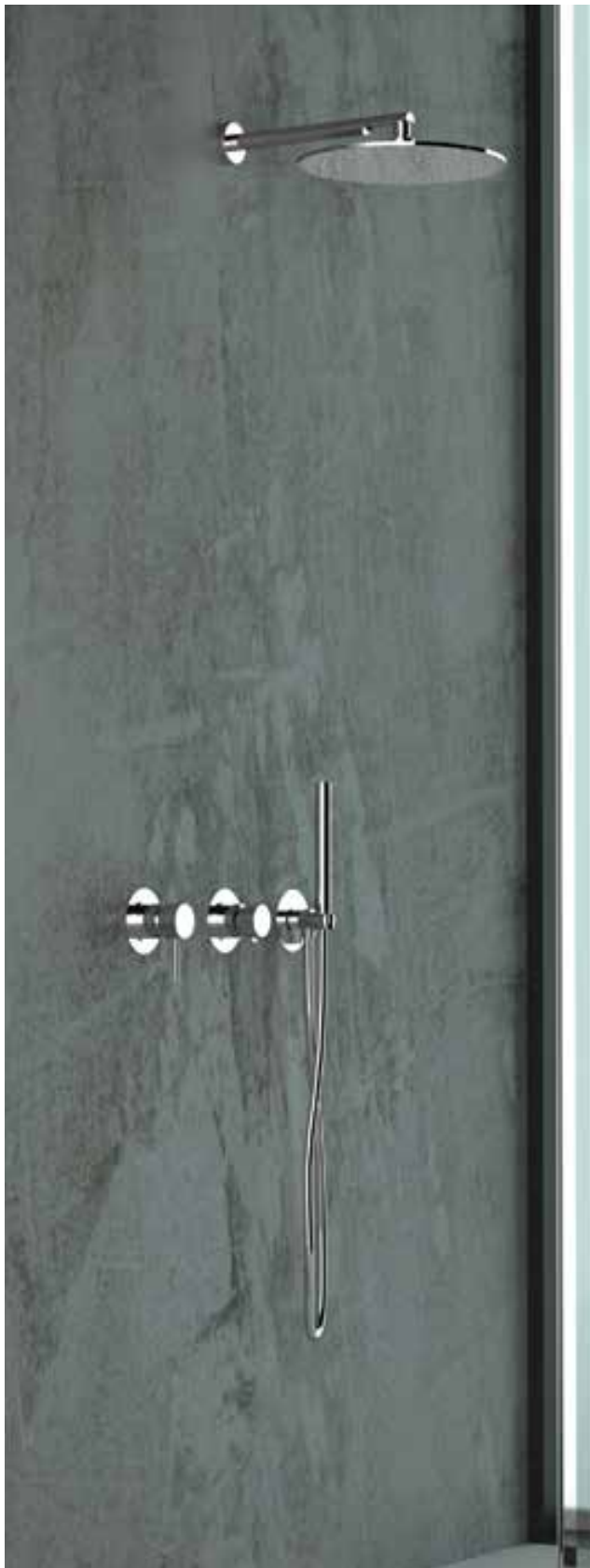

17CUMTX20

**17BUWP2TB20**

Set doccia composto da: miscelatore a incasso con deviatore a 2 vie su unica piastra (173UMP2); soffione Ø 20 cm in ottone (STB0120); braccio a parete in ottone 30 cm (BD00330); doccia a 1 funzione in ottone cromato (191D6); presa acqua a muro con supporto fisso (242MN); flessibile 150 cm.

Shower set including: built-in mixer with 2-way diverter on single plate (173UMP2); Ø 20 cm brass shower head (STB0120); 30 cm brass wall arm (BD00330); 1-function brass hand shower (191D6); wall connection pipe with shower holder (242MN); 150 cm flexible hose.

CR

FIN (.14 .37 .08)

**17AUWP2TB20**

Set doccia composto da: miscelatore a incasso con deviatore a 2 vie su unica piastra (173UMP2); soffione Ø 20 cm in ottone (STB0120); braccio a parete in ottone 30 cm (BD00330); asta saliscendi in ottone; doccia a 1 funzione in ottone cromato (191D6); presa acqua a muro (752N0); flessibile 150 cm.

Shower set including: built-in mixer with 2-way diverter on single plate (173UMP2); Ø 20 cm brass shower head (STB0120); 30 cm brass wall arm (BD00330); brass sliding rail; 1-function brass hand shower (191D6); wall connection pipe (752N0); 150 cm flexible hose.

CR

FIN (.14 .37 .08)

CROMOTERAPIA
COLOR THERAPYSOFFIONI
SHOWER HEADBOCCHE
SPOUTSBOX INCASSO
BUILT-IN BOXINCASSI
BUILT-INTERMOSTATICI
THERMOSTATICSSET DOCCIA
SHOWER SETPANNELLI DOCCIA
SHOWER PANELSCOLONNE DOCCIA
SHOWER COLUMNSSALISCENDI
SLIDING RAILSDOCCETTE
HAND SHOWERS

SHUFOFF

SET PER BORDO VASCA
DECK MOUNTED BATH TUB SET





CROMOTERAPIA
COLOR THERAPY

SOFFIONI
SHOWER HEAD

BOCCHE
SPOUTS

BOX INCASSO
BUILT-IN BOX

INCASSI
BUILT-IN

TERMOSTATICI
THERMOSTATICS

SET DOCCIA
SHOWER SET

PANNELLI DOCCIA
SHOWER PANELS

COLONNE DOCCIA
SHOWER COLUMNS

SAISCENDI
SLIDING RAILS

DOCCETTE
HAND SHOWERS

SHUFOFF

SET PER BORDO VASCA
DECK MOUNTED BATH TUB SET

SET DOCCIA DESIGN A 2 VIE TONDO ROUNDED 2-WAY DESIGN SHOWER SET



17BUWS0001

Set doccia composto da: miscelatore a incasso con deviatore (173UM); soffione a parete ultrapiatto effetto pioggia, in acciaio INOX lucidato (S0001); doccetta a 1 funzione in abs cromato (191HR); presa acqua a muro con supporto fisso (242MN); flessibile 150 cm.

Shower set including: built-in mixer with diverter (173UM); ultra-flat wall shower head with rain jet, in polished stainless steel (S0001); 1-function hand shower in c.p. abs (191HR); wall connection pipe with shower holder (242MN); 150 cm flexible hose.

CR



17AUWS0001

Set doccia composto da: miscelatore a incasso con deviatore (173UM); soffione a parete ultrapiatto effetto pioggia, in acciaio INOX lucidato (S0001); asta saliscendi cromata; doccetta a 1 funzione in abs cromato (191HR); presa acqua a muro (752N0) flessibile 150 cm. Shower set including: built-in mixer with diverter (173UM); ultra-flat wall shower head with rain jet, in polished stainless steel (S0001); c.p. sliding rail; 1-function hand shower in c.p. abs (191HR); wall connection pipe (752N0); 150 cm flexible hose.

CR



17BUWP2S0001

Set doccia composto da: miscelatore a incasso con deviatore a 2 vie su unica piastra (173UMP2); soffione a parete ultrapiatto effetto pioggia, in acciaio INOX lucidato (S0001); doccetta a 1 funzione in abs cromato (191HR); presa acqua a muro con supporto fisso (242MN); flessibile 150 cm.

Shower set including: built-in mixer with 2-way diverter on single plate (173UMP2); ultra-flat wall shower head with rain jet, in polished stainless steel (S0001); 1-function hand shower in c.p. abs (191HR); wall connection pipe with shower holder (242MN); 150 cm flexible hose.

CR

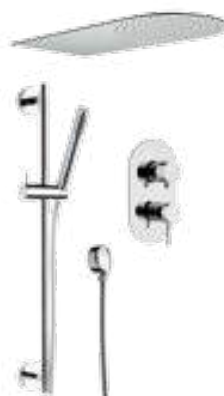

17AUWP2S0001

Set doccia composto da: miscelatore a incasso con deviatore a 2 vie su unica piastra (173UMP2); soffione a parete ultrapiatto effetto pioggia, in acciaio INOX lucidato (S0001); asta saliscendi cromata; doccetta a 1 funzione in abs cromato (191HR); presa acqua a muro (752N0); flessibile 150 cm.

Shower set including: built-in mixer with 2-way diverter on single plate (173UMP2); ultra-flat wall shower head with rain jet, in polished stainless steel (S0001); c.p. sliding rail; 1-function hand shower in c.p. abs (191HR); wall connection pipe (752N0); 150 cm flexible hose.

CR

SET DOCCIA DESIGN A 3 VIE TONDO ROUNDED 3-WAY DESIGN SHOWER SET



17BUWP3S0002

Set doccia composto da: miscelatore a incasso con deviatore a 3 vie su unica piastra (173UMP3); soffione a parete ultrapiatto a 2 getti: pioggia e cascata, in acciaio INOX lucidato (S0002); doccetta a 1 funzione in abs cromato (191HR); presa acqua a muro con supporto fisso (242MN); flessibile 150 cm.

Shower set including: built-in mixer with 3-way diverter on single plate (173UMP3); ultra-flat wall shower head with 2 outlets: rain and waterfall, in polished stainless steel (S0002); 1-function hand shower in c.p. abs (191HR); wall connection pipe with shower holder (242MN); 150 cm flexible hose.

CR



17AUWP3S0002

Set doccia composto da: miscelatore a incasso con deviatore a 3 vie su unica piastra (173UMP3); soffione a parete ultrapiatto a 2 getti: pioggia e cascata, in acciaio INOX lucidato (S0002); asta saliscendi cromata; doccetta a 1 funzione in abs cromato (191HR); presa acqua a muro (752N0); flessibile 150 cm.

Shower set including: built-in mixer with 3-way diverter on single plate (173UMP3); ultra-flat wall shower head with 2 outlets: rain and waterfall, in polished stainless steel (S0002); c.p. sliding rail; 1-function hand shower in c.p. abs (191HR); wall connection pipe (752N0); 150 cm flexible hose.

CR



17BUWP3SST42N

Set doccia composto da: miscelatore a incasso con deviatore a 3 vie su unica piastra (173UMP3); Soffione a soffitto Ø 42 cm a 2 funzioni: pioggia e nebulizzazione (4 uscite) in acciaio INOX lucidato (SST42N); doccetta a 1 funzione in abs cromato (191HR); presa acqua a muro con supporto fisso (242MN); flessibile 150 cm.

Shower set including: built-in mixer with 3-way diverter on single plate (173UMP3); Ø 42 cm ceiling shower head with 2 functions: rain and nebulization (4 outlets), in polished stainless steel (SST42N); 1-function hand shower in c.p. abs (191HR); wall connection pipe with shower holder (242MN); 150 cm flexible hose.

CR



17AUWP3SST42N

Set doccia composto da: miscelatore a incasso con deviatore a 3 vie su unica piastra (173UMP3); soffione a soffitto Ø 42 cm a 2 funzioni: pioggia e nebulizzazione (4 uscite) in acciaio INOX lucidato (SST42N); asta saliscendi cromata; doccetta a 1 funzione in abs cromato (191HR); presa acqua a muro (752N0); flessibile 150 cm.

Shower set including: built-in mixer with 3-way diverter on single plate (173UMP3); Ø 42 cm ceiling shower head with 2 functions: rain and nebulization (4 outlets), in polished stainless steel (SST42N); c.p. sliding rail; 1-function hand shower in c.p. abs (191HR); wall connection pipe (752N0); 150 cm flexible hose.

CR

CROMOTERAPIA
COLOR THERAPYSOFFIONI
SHOWER HEADBOCCHE
SPOUTSBOX INCASSO
BUILT-IN BOXINCASSI
BUILT-INTHERMOSTATICI
THERMOSTATICSSET DOCCIA
SHOWER SETPANNELLI DOCCIA
SHOWER PANELSCOLONNE DOCCIA
SHOWER COLUMNSSALISCENTI
SLIDING RAILSDOCCETTE
HAND SHOWERS

SHUFOFF

SET PER BORDO VASCA
DECK MOUNTED BATH TUB SET

SET DOCCIA DESIGN A 4 VIE TONDO ROUNDED 4-WAY DESIGN SHOWER SET



17BUWP4

Set doccia composto da: miscelatore a incasso con deviatore a 4 vie su unica piastra (173UMP4); soffione a soffitto Ø 42 cm a 2 funzioni: pioggia e nebulizzazione (4 uscite) in acciaio INOX lucidato (SST42N); doccetta a 1 funzione in ottone cromato (191D6); presa acqua a muro con supporto fisso (242MN); bocca a cascata ad incasso (134UMX); flessibile 150 cm.

Shower set including: built-in mixer with 4-way diverter on single plate (173UMP4); Ø 42 cm ceiling shower head with 2 functions: rain and nebulization (4 outlets), in polished stainless steel (SST42N); 1-function brass hand shower (191D6); wall connection pipe with shower holder (242MN); built-in waterfall spout (134UMX); 150 cm flexible hose.

CR



17AUWP4

Set doccia composto da: miscelatore a incasso con deviatore a 4 vie su unica piastra (173UMP4); soffione a soffitto Ø 42 cm a 2 funzioni: pioggia e nebulizzazione (4 uscite) in acciaio INOX lucidato (SST42N); asta saliscendi cromata; doccetta a 1 funzione in ottone cromato (191D6); presa acqua a muro (752N0); bocca a cascata ad incasso (134UMX); flessibile 150 cm.

Shower set including: built-in mixer with 4-way diverter on single plate (173UMP4); Ø 42 cm ceiling shower head with 2 functions: rain and nebulization (4 outlets), in polished stainless steel (SST42N); c.p. sliding rail; 1-function brass hand shower (191D6); wall connection pipe (752N0); built-in waterfall spout (134UMX); 150 cm flexible hose.

CR

SET DOCCIA DESIGN A 5 VIE TONDO ROUNDED 5-WAY DESIGN SHOWER SET



17BUWP5

Set doccia composto da: miscelatore a incasso con deviatore a 5 vie su unica piastra (173UMP5); soffione a soffitto Ø 42 cm a 2 funzioni: pioggia e nebulizzazione (4 uscite) in acciaio INOX lucidato (SST42N); doccetta a 1 funzione in ottone cromato (191D6); presa acqua a muro con supporto fisso (242MN); 6 getti a muro in ottone orientabili (GT001); bocca a cascata ad incasso (134UMX); flessibile 150 cm.

Shower set including: built-in mixer with 5-way diverter on a single plate (173UMP5); Ø 42 cm ceiling shower head with 2 functions: rain and nebulization (4 outlets), in polished stainless steel (SST42N); 1-function brass hand shower (191D6); wall connection pipe with shower holder (242MN); 6 adjustable brass wall jets (GT001); built-in waterfall spout (134UMX); 150 cm flexible hose.

CR



17AUWP5

Set doccia composto da: miscelatore a incasso con deviatore a 5 vie su unica piastra (173UMP5); Soffione a soffitto Ø 42 cm a 2 funzioni: pioggia e nebulizzazione (4 uscite) in acciaio INOX lucidato (SST42N); asta saliscendi cromata; doccetta a 1 funzione in ottone cromato (191D6); presa acqua a muro (752N0); 6 getti a muro in ottone orientabili (GT001); bocca a cascata ad incasso (134UMX); flessibile 150 cm.

Shower set including: built-in mixer with 5-way diverter on a single plate (173UMP5); Ø 42 cm ceiling shower head with 2 functions: rain and nebulization (4 outlets), in polished stainless steel (SST42N); c.p. sliding rail; 1-function brass hand shower (191D6); wall connection pipe (752N0); 6 adjustable brass wall jets (GT001); built-in waterfall spout (134UMX); 150 cm flexible hose.

CR



17AUWP4

SET PER BORDO VASCA
DECK MOUNTED BATHTUB SET

SHUFOFF

DOCCETTE
HAND SHOWERS

SALISCENDI
SLIDING RAILS

COLONNE DOCCIA
SHOWER COLUMNS

PANNELLI DOCCIA
SHOWER PANELS

SET DOCCIA
SHOWER SET

TERMOSTATICI
THERMOSTATICS

INCASSI
BUILT-IN

BOX INCASSO
BUILT-IN BOX

BOCCHE
SPOUTS

SOFFIONI
SHOWER HEAD

CROMOTERAPIA
COLOR THERAPY

SET DOCCIA SENZA MISCELATORE SHOWER SET WITHOUT MIXER



Set doccia composto da: soffione ultrapiatto Ø 20 cm, in acciaio INOX lucidato (ST00120); braccio a parete in ottone 30 cm (BD00330); doccetta a 1 funzione in abs cromato (191HR); presa acqua a muro con supporto fisso (242MN); flessibile 150 cm. Da abbinare ad un miscelatore a incasso con deviatore (NON INCUSO).

Shower set including: Ø 20 cm ultra-flat shower head in polished stainless steel (ST00120); 30 cm brass wall arm (BD00330); 1-function hand shower in c.p. abs (191HR); wall connection pipe with shower holder (242MN); 150 cm flexible hose. To be combined with a built-in mixer with diverter (NOT INCLUDED).

249UM20X con soffione ultrapiatto 20 cm.
with Ø 20 cm ultra-flat shower head.

249UM25X con soffione ultrapiatto Ø 25 cm.
with Ø 25 cm ultra-flat shower head.

249UM30X con soffione ultrapiatto Ø 30 cm.
with Ø 30 cm ultra-flat shower head.



Set doccia composto da: soffione ultrapiatto 20x20 cm in acciaio INOX lucidato (SQ00420); braccio a parete 30 cm in ottone, forma squadrata (BD00430); doccetta a 1 funzione in abs cromato (191QD); presa acqua con supporto fisso (242PA); flessibile 150 cm. Da abbinare ad un miscelatore a incasso con deviatore (NON INCUSO).

Shower set including: 20x20 cm ultra-flat shower head in polished stainless steel (SQ00420); 30 cm brass shower arm, squared shape (BD00430); 1-function hand shower in c.p. abs (191QD); brass connection pipe with shower holder (242PA); 150 cm flexible hose. To be combined with a built-in mixer with diverter (NOT INCLUDED).

249QD20X con soffione ultrapiatto 20x20 cm.
with 20x20 cm ultra-flat shower head.

249QD25X con soffione ultrapiatto 25x25 cm.
with 25x25 cm ultra-flat shower head.

249QD30X con soffione ultrapiatto 30x30 cm.
with 30x30 cm ultra-flat shower head.



Set doccia composto da: soffione in ABS cromato (STA0120); braccio a parete in ottone 30 cm (BDL0530); doccetta a 1 funzione in abs cromato (191HR); presa acqua a muro con supporto fisso (242MN); flessibile 150 cm. Da abbinare ad un miscelatore a incasso con deviatore (NON INCUSO).

Shower set including: Ø 20 cm shower head in chromed ABS (STA0120); brass wall arm 30 cm (BDL0530); 1-function shower in chromed abs (191HR); wall connection pipe with shower holder (242MN); flexible 150 cm. To be combined with a built-in mixer with diverter (NOT INCLUDED).

249UM20A con soffione 20 cm.
with Ø 20 cm shower head.

249UM25A con soffione Ø 25 cm.
with Ø 25 cm shower head.

249UM30A con soffione Ø 30 cm.
with Ø 30 cm shower head.



Set doccia composto da: soffione in abs cromato (SQA0120); braccio a parete 30 cm in ottone, forma squadrata (BD00430); doccetta a 1 funzione in abs cromato (191QD); presa acqua con supporto fisso (242PA); flessibile 150 cm. Da abbinare ad un miscelatore a incasso con deviatore (NON INCUSO).

Shower set including: shower head in chromed abs (SQA0120); 30 cm brass wall arm, squared shape (BD00430); 1-function handshower in chromed abs (191QD); brass connection pipe with shower holder (242PA); 150 cm flexible hose. To be combined with a built-in mixer with diverter (NOT INCLUDED).

249QD20A con soffione 20x20 cm.
with 20x20 cm shower head.

249QD25A con soffione 25x25 cm.
with 25x25 cm shower head.

249QD30A con soffione 30x30 cm.
with 30x30 cm shower head.



Set doccia composto da: soffione in ottone (STB0120); braccio a parete in ottone 30 cm (BD00330); doccetta a 1 funzione in ottone cromato (191D6); presa acqua a muro con supporto fisso (242MN); flessibile 150 cm. Da abbinare ad un miscelatore a incasso con deviatore (NON INCUSO).

Shower set including: brass shower head (STB0120); 30 cm brass wall arm (BD00330); 1-function brass hand shower (191D6); wall connection pipe with shower holder (242MN); 150 cm flexible hose. To be combined with a built-in mixer with diverter (NOT INCLUDED).

249UM20B con soffione Ø 20 cm.
with Ø 20 cm shower head.

249UM30B con soffione Ø 30 cm.
with Ø 30 cm shower head.



Set doccia composto da: soffione in ottone cromato (SQB0120); braccio a parete 30 cm in ottone, forma quadrata (BD00430); doccetta minimale quadrata a 1 funzione, in ottone (191PF); presa acqua con supporto fisso (242PA); flessibile 150 cm. Da abbinare ad un miscelatore a incasso con deviatore (NON INCUSO).

Shower set including: shower head in c.p. brass (SQB0120); 30 cm brass shower arm, squared shape (BD00430); 1-function squared hand shower, in brass (191PF); brass connection pipe with shower holder (242PA); 150 cm flexible hose. To be combined with a built-in mixer with diverter (NOT INCLUDED).

249QD20B con soffione 20x20 cm.
with 20x20 cm shower head.

249QD30B con soffione 30x30 cm.
with 30x30 cm shower head.





PANNELLI DOCCIA SHOWER PANELS

CROMOTERAPIA
COLOR THERAPY

SOFFIONI
SHOWER HEAD

BOCCHE
SPOUTS

BOX INCASSO
BUILT-IN BOX

INCASSI
BUILT-IN

TERMOSTATICI
THERMOSTATICS

SET DOCCIA
SHOWER SET

PANNELLI DOCCIA
SHOWER PANELS

COLONNE DOCCIA
SHOWER COLUMNS

SALISCENDI
SLIDING RAILS

DOCCETTE
HAND SHOWERS

SHUFOFF

SET PER BORDO VASCA
DECK MOUNTED BATH TUB SET

PANNELLI DOCCIA CON MISCELATORE SHOWER PANELS WITH MIXER

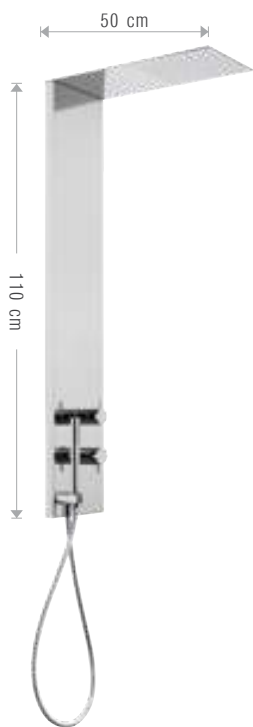

780SP

Pannello doccia a parete, monocomando con deviatore a 2 vie, in acciaio INOX lucidato a specchio, getto a pioggia anti-calcare, doccetta anti-calcare in ABS cromato, flessibile in PVC da 150 cm.

Stainless steel mirror polished wall mounted shower panel, single-lever with 2 ways diverter, rain jet with anti-limestone system, c.p. ABS handshower with anti-limestone system, PVC flexible hose 150 cm.

CR



780SPJC

Pannello doccia a parete, monocomando con deviatore a 4 vie, in acciaio INOX lucidato a specchio, getto a pioggia anti-calcare e getto a cascata, body jets anti-calcare, doccetta anti-calcare in ABS cromato, flessibile in PVC da 150 cm.

Stainless steel mirror polished wall mounted shower panel, single-lever with 4 ways diverter, rain jet with anti-limestone system, waterfall jet, anti-limestone body jets, c.p. ABS handshower with anti-limestone system, PVC flexible hose 150 cm.

CR



780SP

PANNELLI DOCCIA TERMOSTATICI THERMOSTATIC SHOWER PANELS



780SPT

Pannello doccia a parete **termostatico** coassiale, monocomando con deviatore a 2 vie, in acciaio INOX lucidato a specchio, getto a pioggia anti-calcare, doccetta anti-calcare in ABS cromato, flessibile in PVC da 150 cm. Stainless steel mirror polished wall mounted **thermostatic** coaxial shower panel, single-lever with 2 ways diverter, rain jet with anti-limestone system, c.p. ABS handshower with anti-limestone system, PVC flexible hose 150 cm.

CR



780SPTJC

Pannello doccia a parete **termostatico**, monocomando con deviatore a 4 vie, in acciaio INOX lucidato a specchio, getto a pioggia anti-calcare e getto a cascata, body jets anti-calcare, doccetta anti-calcare in ABS cromato, flessibile in PVC da 150 cm. Stainless steel mirror polished wall mounted **thermostatic** shower panel, single-lever with 4 ways diverter, rain jet with anti-limestone system, waterfall jet, anti-limestone body jets, c.p. ABS handshower with anti-limestone system, PVC flexible hose 150 cm.

CR

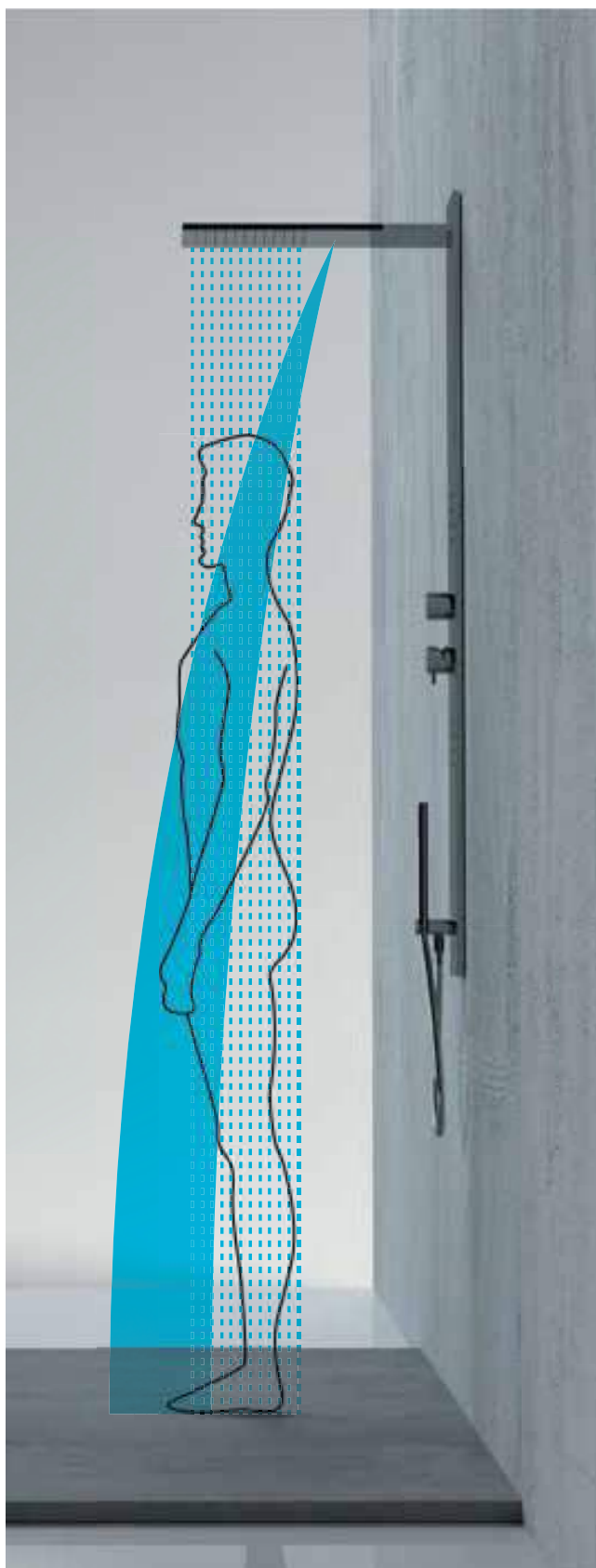

CROMOTERAPIA
COLOR THERAPY

SOFFIONI
SHOWER HEAD

BOCCHE
SPOUTS

BOX INCASSO
BUILT-IN BOX

INCASSI
BUILT-IN

TERMOSTATICI
THERMOSTATICS

SET DOCCIA
SHOWER SET

PANNELLI DOCCIA
SHOWER PANELS

COLONNE DOCCIA
SHOWER COLUMNS

SALISCENDI
SLIDING RAILS

DOCCETTE
HAND SHOWERS

SHUOFF

SET PER BORDO VASCA
DECK MOUNTED BATH TUB SET

PANNELLI DOCCIA AD INCASSO BUILT-IN SHOWER PANELS

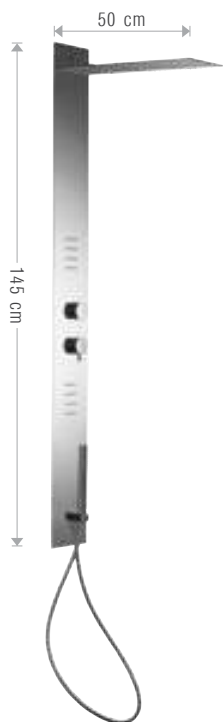

781SPJ

Pannello doccia ad incasso, monocomando con deviatore a 3 vie, in acciaio INOX lucidato a specchio, getto a pioggia anti-calcare, body jets anti-calcare, doccetta anti-calcare in ABS cromato, flessibile in PVC da 150 cm.

Stainless steel mirror polished wall mounted shower panel, single-lever with 3 ways diverter, rain jet with anti-limestone system, anti-limestone system body jets, c.p. ABS handshower with anti-limestone system, PVC flexible hose 150 cm.

CR

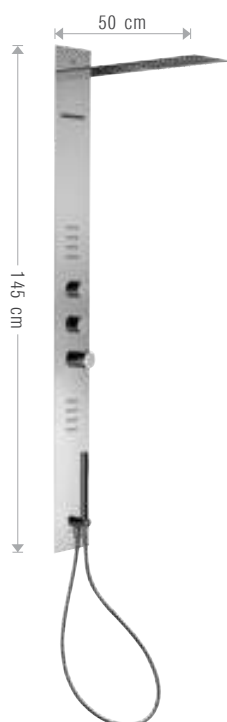

781SPTJC

Pannello doccia ad incasso **termostatico**, monocomando con deviatore a 4 vie, in acciaio INOX lucidato a specchio, getto a pioggia anti-calcare, getto cascata, body jets anti-calcare, doccetta anti-calcare in ABS cromato, flessibile in PVC da 150 cm.

Stainless steel mirror polished wall mounted **thermostatic** shower panel, single-lever with 4 ways diverter, rain jet with anti-limestone system, waterfall jet, anti-limestone system body jets, c.p. ABS handshower with anti-limestone system, PVC flexible hose 150 cm.

CR





CROMOTERAPIA
COLOR THERAPY

SOFFIONI
SHOWER HEAD

BOCCHE
SPOUTS

BOX INCASSO
BUILT-IN BOX

INCASSI
BUILT-IN

TERMOSTATICI
THERMOSTATICS

SET DOCCIA
SHOWER SET

PANNELLI DOCCIA
SHOWER PANELS

COLONNE DOCCIA
SHOWER COLUMNS

SLISCENDI
SLIDING RAILS

DOCCETTE
HAND SHOWERS

SHUFOFF

SET PER BORDO VASCA
DECK MOUNTED BATH TUB SET

781SPTJC





COLONNE DOCCIA SHOWER COLUMN

CROMOTERAPIA
COLOR THERAPYSOFFIONI
SHOWER HEADBOCCHE
SPOUTSBOX INCASSO
BUILT-IN BOXINCASSI
BUILT-INTERMOSTATICI
THERMOSTATICSSET DOCCIA
SHOWER SETPANNELLI DOCCIA
SHOWER PANELSCOLONNE DOCCIA
SHOWER COLUMNSALISCENDI
SLIDING RAILSDOCCETTE
HAND SHOWERS

SHUFOFF

SET PER BORDO VASCA
DECK MOUNTED BATH TUB SET

COLONNE DOCCIA QUADRATE SQUARED SHOWER COLUMNS



Colonna doccia composta da: miscelatore monocomando esterno (259PA); soffione ultrapiatto in acciaio INOX lucidato (SQ00420); colonna con fissaggio superiore scorrevole, deviatore; doccetta a 1 funzione in abs cromato (191QD); flessibile 150 cm.
Shower column including: exposed mixer (259PA); ultra-flat shower head in polished stainless steel (SQ00420); column with sliding upper fixing and diverter; 1-function hand shower in c.p. abs (191QD); 150 cm flexible hose.

- 259PAXQX20** 20x20cm
- 259PAXQX25** 25x25cm
- 259PAXQX30** 30x30cm



Colonna doccia composta da: miscelatore monocomando esterno (259PA); soffione in abs cromato (SQA0120); colonna quadrata in ottone con deviatore; doccetta a 1 funzione in abs cromato (191QD); flessibile 150 cm.
Shower column including: exposed mixer (259PA); shower head in c.p. abs (SQA0120); brass squared column with diverter; 1-function hand shower in c.p. abs (191QD); 150 cm flexible hose.

- A39C1** 20x20cm
- A39C1QA25** 25x25cm
- A39C1QA30** 30x30cm

CON OPZIONI DI FINITURA WITH FINISHING OPTIONS



Colonna doccia composta da: miscelatore monocomando esterno (259PA); soffione ultrapiatto in acciaio INOX lucidato (SQ00420); colonna quadrata in ottone con deviatore; doccetta a 1 funzione in abs cromato (191QD); flessibile 150 cm.
Shower column including: exposed mixer (259PA); ultra-flat shower head in polished stainless steel (SQ00420); brass squared column with diverter; 1-function hand shower in c.p. abs (191QD); 150 cm flexible hose.

- A51C1QX20** 20x20cm
- A51C1QX25** 25x25cm
- A51C1** 30x30cm



259PASQB20

Colonna doccia composta da: miscelatore monocomando esterno (259PA); soffione Ø 20 cm in ottone (STB0120); colonna quadrata in ottone con deviatore; doccetta minimale quadrata a 1 funzione, in ottone (191PF); flessibile 150 cm.
Shower column including: exposed mixer (259PA); Ø 20 cm brass shower head (STB0120); brass squared column with diverter; 1-function squared hand shower, in brass (191PF); 150 cm flexible hose.

- CR**
- FIN (.14.37.08)**

COLONNE DOCCIA TONDE ROUNDED SHOWER COLUMNS

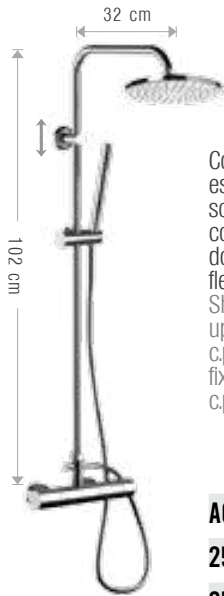

Colonna doccia composta da: miscelatore esterno con attacco superiore da 3/4" (259NX); soffione in ABS cromato (STA0120); colonna con fissaggio superiore scorrevole, deviatore; doccetta a 1 funzione in abs cromato (191HR); flessibile 150 cm.

Shower column including: exposed mixer with upper 3/4" connection (259NX); shower head in c.p. abs (STA0120); column with sliding upper fixing and diverter; 1-function hand shower in c.p. abs (191HR); 150 cm flexible hose.

A66MN Ø 20cm

259NXXTA25 Ø 25cm

259NXXTA30 Ø 30cm



Colonna doccia composta da: miscelatore esterno con attacco superiore da 3/4" (259NX); soffione ultrapiatto, in acciaio INOX lucidato (ST00120); colonna con fissaggio superiore scorrevole, deviatore; doccetta a 1 funzione in abs cromato (191HR); flessibile 150 cm.

Shower column including: exposed mixer with upper 3/4" connection (259NX); ultra-flat shower head in polished stainless steel (ST00120); column with sliding upper fixing and diverter; 1-function hand shower in c.p. abs (191HR); 150 cm flexible hose.

259NXXTX20 Ø 20cm

259NXXTX25 Ø 25cm

259NXXTX30 Ø 30cm

CON OPZIONI DI FINITURA WITH FINISHING OPTIONS



Colonna doccia composta da: gruppo doccia a muro bicomando; soffione a campana in ottone Ø 20 cm; colonna con deviatore, flessibile 150 cm; doccetta a 1 funzione, in ottone (191TS).

Shower column including: 2-handle exposed shower system; brass bell shaped shower head Ø 20 cm; column with diverter, 150 cm flexible hose; 1-function brass hand shower (191TS);

A44CD



259NXUTB20

Colonna doccia composta da: miscelatore esterno con attacco superiore da 3/4" (259NX); soffione Ø 20 cm in ottone (STB0120); colonna girevole con deviatore; doccetta a 1 funzione in ottone cromato (191D6); flessibile 150 cm.

Shower column including: exposed mixer with upper 3/4" connection (259NX); Ø 20 cm brass shower head (STB0120); swivel column with diverter; 1-function brass hand shower (191D6); 150 cm flexible hose.

CR

FIN (.14.37.08)





SET PER BORDO VASCA
DECK MOUNTED BATH/TUB SET

SHUFOFF

DOCCETTE
HAND SHOWERS

SALISCENDI
SLIDING RAILS

COLONNE DOCCIA
SHOWER COLUMNS

PANNELLI DOCCIA
SHOWER PANELS

SET DOCCIA
SHOWER SET

TERMOSTATICI
THERMOSTATICS

INCASSI
BUILT-IN

BOX INCASSO
BUILT-IN BOX

BOCCHE
SPOUTS

SOFFIONI
SHOWER HEAD

CROMOTERAPIA
COLOR THERAPY

COLONNE DOCCIA TELESCOPICHE TONDE ROUNDED TELESCOPIC SHOWER COLUMNS

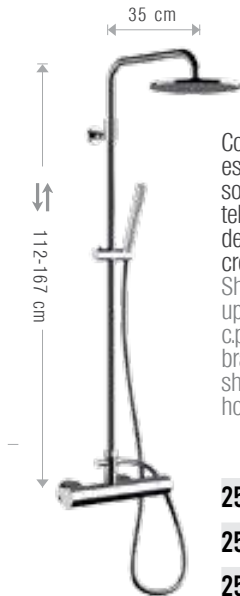

Colonna doccia composta da: miscelatore esterno con attacco superiore da 3/4" (259NX); soffione in ABS cromato (STA0120); colonna telescopica in ottone con altezza regolabile, deviatore; doccetta a 1 funzione in abs cromato (191HR); flessibile 150 cm.
Shower column including: exposed mixer with upper 3/4" connection (259NX); shower head in c.p. abs (STA0120); height-adjustable telescopic brass column with diverter; 1-function hand shower in c.p. abs (191HR); 150 cm flexible hose.

259NXATA20 Ø 20cm

259NXATA25 Ø 25cm

259NXATA30 Ø 30cm

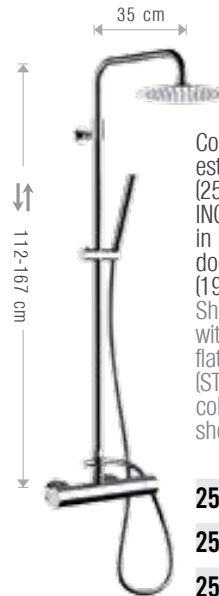

Colonna doccia composta da: miscelatore esterno con attacco superiore da 3/4" (259NX); soffione ultrapiatto, in acciaio INOX lucidato (ST00120); colonna telescopica in ottone con altezza regolabile, deviatore; doccetta a 1 funzione in ottone cromato (191D6); flessibile 150 cm.

Shower column including: exposed mixer with upper 3/4" connection (259NX); ultra-flat shower head in polished stainless steel (ST00120); height-adjustable telescopic brass column with diverter; 1-function brass hand shower (191D6); 150 cm flexible hose.

259NXATX20 Ø 20cm

259NXATX25 Ø 25cm

259NXATX30 Ø 30cm

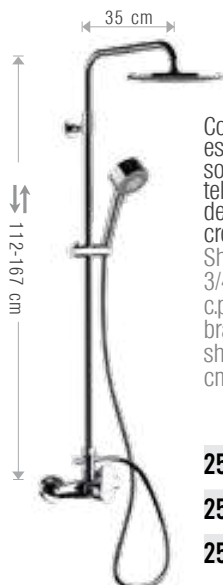

Colonna doccia composta da: miscelatore esterno con attacco alto da 3/4" (259AT); soffione in ABS cromato (STA0120); colonna telescopica in ottone con altezza regolabile, deviatore; doccetta a 4 funzioni in abs cromato con getti in silicone; flessibile 150 cm.
Shower column including: exposed mixer with 3/4" upper connection (259AT); shower head in c.p. abs (STA0120); height-adjustable telescopic brass column with diverter; 4-function hand shower in chromed abs with silicone jets; 150 cm flexible hose.

259ATATA20 Ø 20cm

259ATATA25 Ø 25cm

259ATATA30 Ø 30cm

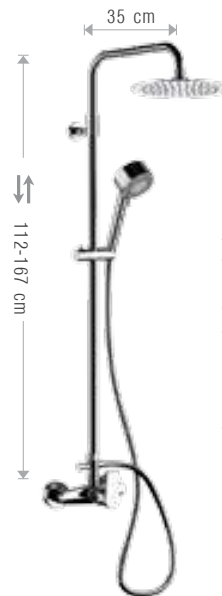

Colonna doccia composta da: miscelatore esterno con attacco alto da 3/4" (259AT); soffione ultrapiatto, in acciaio INOX lucidato (ST00120); colonna telescopica in ottone con altezza regolabile, deviatore; doccetta a 4 funzioni in abs cromato con getti in silicone; flessibile 150 cm.

Shower column including: exposed mixer with 3/4" upper connection (259AT); ultra-flat shower head in polished stainless steel (ST00120); height-adjustable telescopic brass column with diverter; 4-function hand shower in chromed abs with silicone jets; 150 cm flexible hose.

259ATATX20 Ø 20cm

259ATATX25 Ø 25cm

259ATATX30 Ø 30cm

COLONNE A 3 VIE PER VASCA/DOCCIA 3-WAY COLUMNS FOR BATH/SHOWER

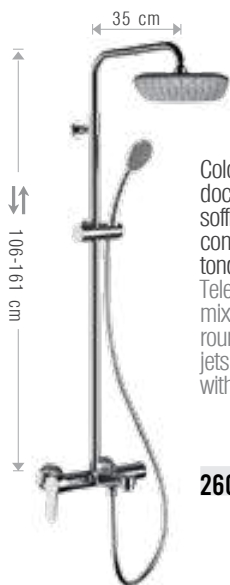

Colonna doccia telescopica con miscelatore doccia a 3 vie serie SURF con deviatore integrato, soffione quadrato con angoli arrotondati in ABS con getti anticalcare **20x20 cm**, doccetta in ABS tonda ad 1 funzione con getti anticalcare. Telescopic shower column with 3 ways SURF mixer with integrated diverter, ABS squared with round corners shower head, with anti-limestone jets **20x20 cm**, 1 function ABS round handshower with anti-limestone jets.

260SFADA20

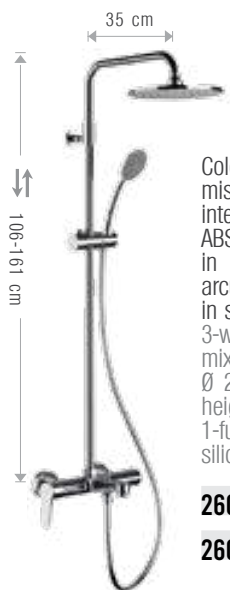

Colonna doccia a 3 vie composta da: miscelatore vasca/doccia con deviatore integrato nella bocca; soffione Ø 20 cm in ABS cromato (STA0120); colonna telescopica in ottone con altezza regolabile; doccetta arcuata a 1 funzione in abs cromato con getti in silicone (191N0); flessibile 150 cm.

3-way shower column including: bath/shower mixer with diverter integrated in the spout; Ø 20 cm shower head in c.p. abs (STA0120); height-adjustable telescopic brass column; 1-function curved hand shower in c.p. abs with silicone jets (191N0); 150 cm flexible hose.

260SFATA20

260SFATA25



260SFATA20

CROMOTERAPIA
COLOR THERAPY

SOFFIONI
SHOWER HEAD

BOCCHE
SPOUTS

BOX INCASSO
BUILT-IN BOX

INCASSI
BUILT-IN

TERMOSTATICI
THERMOSTATICS

SET DOCCIA
SHOWER SET

PANNELLI DOCCIA
SHOWER PANELS

COLONNE DOCCIA
SHOWER COLUMNS

SALISCENDI
SLIDING RAILS

DOCCETTE
HAND SHOWERS

SHU-OFF

SET PER BORDO VASCA
DECK MOUNTED BATH/TUB SET

COLONNE DOCCIA CON ATTACCO ESTERNO SHOWER COLUMNS WITH EXTERNAL CONNECTION

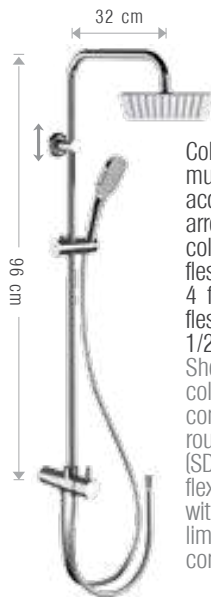

Colonna doccia composta da: supporto a muro per colonna con deviatore e presa acqua inferiore; soffione ultrapiatto con angoli arrotondati in acciaio INOX lucidato (SD00120); colonna con fissaggio superiore scorrevole, flessibile doccia 150 cm; doccetta in abs a 4 funzioni con pulsante per il cambio getto; flessibile 50 cm per collegamento esterno, 1/2Fx1/2F.

Shower column including: wall mounting column holder with diverter and lower connection; ultra-flat shower head with rounded corners in polished stainless steel (SD00120); column with sliding upper fixing, flexible hose 150 cm; 4-function hand shower with button for changing the jets, abs, anti-limescale; 50 cm flexible hose for the external connection, 1/2Fx1/2F.

122NXXDX20 20X20cm

122NXXDX25 25X25cm

122NXXDX30 30X30cm

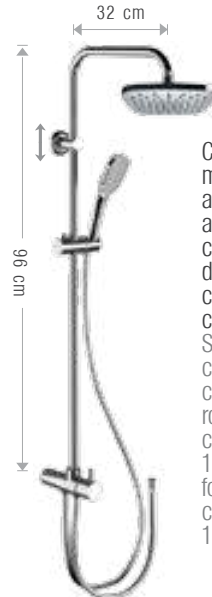

Colonna doccia composta da: supporto a muro per colonna con deviatore e presa acqua inferiore; soffione 20x20 cm con angoli arrotondati in ABS cromato (SDA0120); colonna con fissaggio superiore scorrevole, flessibile doccia 150 cm; doccetta in abs a 4 funzioni con pulsante per il cambio getto; flessibile 50 cm per collegamento esterno, 1/2Fx1/2F.

Shower column including: wall mounting column holder with diverter and lower connection; 20x20 cm shower head with rounded corners in c.p. ABS (SDA0120); column with sliding upper fixing, flexible hose 150 cm; 4-function hand shower with button for changing the jets, abs, anti-limescale; 50 cm flexible hose for the external connection, 1/2Fx1/2F.

122NXXDA20 20X20cm



Colonna doccia composta da: supporto a muro per colonna con deviatore e presa acqua inferiore; soffione ultrapiatto, in acciaio INOX lucidato (ST00120); colonna con fissaggio superiore scorrevole, flessibile doccia 150 cm; doccetta a 1 funzione in abs cromato (191HR); flessibile 50 cm per collegamento esterno, 1/2Fx1/2F.

Shower column including: wall mounting column holder with diverter and lower connection; ultra-flat shower head in polished stainless steel (ST00120); column with sliding upper fixing, flexible hose 150 cm; 1-function hand shower in c.p. abs (191HR); 50 cm flexible hose for the external connection, 1/2Fx1/2F.

122NXXTX20 Ø 20cm

122NXXTX25 Ø 25cm

122NXXTX30 Ø 30cm

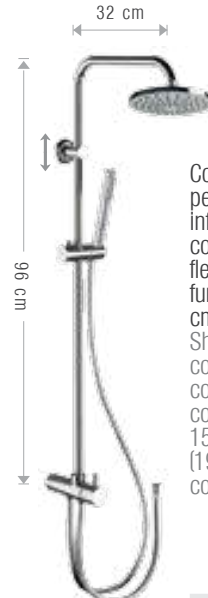

Colonna doccia composta da: supporto a muro per colonna con deviatore e presa acqua inferiore; soffione in ABS cromato (STA0120); colonna con fissaggio superiore scorrevole, flessibile doccia 150 cm; doccetta a 1 funzione in abs cromato (191HR); flessibile 50 cm per collegamento esterno, 1/2Fx1/2F.

Shower column including: wall mounting column holder with diverter and lower connection; shower head in c.p. abs (STA0120); column with sliding upper fixing, flexible hose 150 cm; 1-function hand shower in c.p. abs (191HR); 50 cm flexible hose for the external connection, 1/2Fx1/2F.

122NXXTA20 Ø 20cm

122NXXTA25 Ø 25cm

122NXXTA30 Ø 30cm

COLONNE DOCCIA TELESCOPICHE CON ATTACCO ESTERNO TELESCOPIC SHOWER COLUMNS WITH EXTERNAL CONNECTION

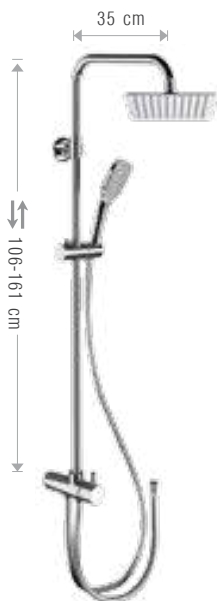

Colonna doccia composta da: supporto a muro per colonna con deviatore e presa acqua inferiore; soffione ultrapiatto in acciaio INOX lucidato (SD00120); colonna telescopica in ottone con altezza regolabile, flessibile doccia 150 cm; doccetta in abs a 4 funzioni con pulsante per il cambio getto; flessibile 50 cm per collegamento esterno, 1/2Fx1/2F.

Shower column including: wall mounting column holder with diverter and lower connection; ultra-flat shower head with rounded corners in polished stainless steel (SD00120); height-adjustable telescopic brass column, flexible hose 150 cm; 4-function hand shower with button for changing the jets, abs, anti-limescale; 50 cm flexible hose for the external connection, 1/2Fx1/2F.

122NXADX20 20X20cm

122NXADX25 25X25cm

122NXADX30 30X30cm



Colonna doccia composta da: supporto a muro per colonna con deviatore e presa acqua inferiore; soffione con angoli arrotondati in ABS cromato (SDA0120); colonna telescopica in ottone con altezza regolabile, flessibile doccia 150 cm; doccetta in abs a 4 funzioni con pulsante per il cambio getto; flessibile 50 cm per collegamento esterno, 1/2Fx1/2F.

Shower column including: wall mounting column holder with diverter and lower connection; shower head with rounded corners in c.p. ABS (SDA0120); height-adjustable telescopic brass column, flexible hose 150 cm; 4-function hand shower with button for changing the jets, abs, anti-limescale; 50 cm flexible hose for the external connection, 1/2Fx1/2F.

122NXADA20 20X20cm

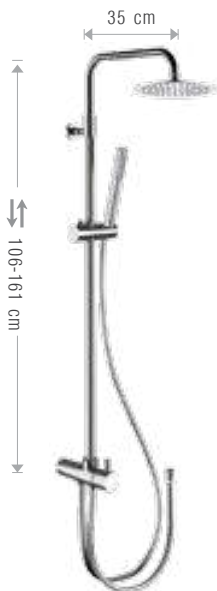

Colonna doccia composta da: supporto a muro per colonna con deviatore e presa acqua inferiore; soffione ultrapiatto, in acciaio INOX lucidato (ST00120); colonna telescopica in ottone con altezza regolabile, flessibile doccia 150 cm; doccetta a 1 funzione in abs cromato (191HR); flessibile 50 cm per collegamento esterno, 1/2Fx1/2F.

Shower column including: wall mounting column holder with diverter and lower connection; ultra-flat shower head in polished stainless steel (ST00120); height-adjustable telescopic brass column, flexible hose 150 cm; 1-function hand shower in c.p. abs (191HR); 50 cm flexible hose for the external connection, 1/2Fx1/2F.

122NXATX20 Ø 20cm

122NXATX25 Ø 25cm

122NXATX30 Ø 30cm

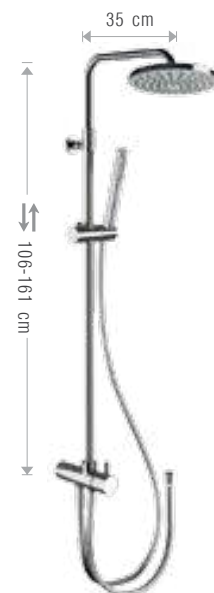

Colonna doccia composta da: supporto a muro per colonna con deviatore e presa acqua inferiore; soffione ultrapiatto in acciaio INOX lucidato (ST00120); colonna telescopica in ottone con altezza regolabile, flessibile doccia 150 cm; doccetta a 1 funzione in abs cromato (191HR); flessibile 50 cm per collegamento esterno, 1/2Fx1/2F.

Shower column including: wall mounting column holder with diverter and lower connection; ultra-flat shower head in polished stainless steel (ST00120); height-adjustable telescopic brass column, flexible hose 150 cm; 1-function hand shower in c.p. abs (191HR); 50 cm flexible hose for the external connection, 1/2Fx1/2F.

122NXATA20 Ø 20cm

122NXATA25 Ø 25cm

122NXATA30 Ø 30cm

CROMOTERAPIA
COLOR THERAPYSOFFIONI
SHOWER HEADBOCCHE
SPOUTSBOX INCASSO
BUILT-IN BOXINCASSI
BUILT-INTHERMOSTATICI
THERMOSTATICSSET DOCCIA
SHOWER SETPANNELLI DOCCIA
SHOWER PANELSCOLONNE DOCCIA
SHOWER COLUMNSSALISCENDI
SLIDING RAILSDOCCETTE
HAND SHOWERS

SHUOFF

SET PER BORDO VASCA
DECK MOUNTED BATH TUB SET



789CP

COLONNE PISCINA AUTOPORTANTI FREE-STANDING SHOWER COLUMNS



789CP

Colonna doccia da esterno in acciaio INOX, monocomando a 2 vie con getto pioggia anti-calcare e getto cascata, acqua calda/fredda con attacco da pavimento.

Stainless steel shower column for outside, single-lever 2 ways diverter rain jet with anti-limestone system and waterfall jet, mixer hot/cold water control for shower, floor mounted.

CR



786CP

Colonna free-standing con miscelatore acqua calda/fredda con attacco dell'acqua a pavimento, soffione anticalcare completamente in ottone cromato.

Free standing column with single-lever mixer hot/cold water control, floor water connection, anti-limestone shower head. Completely in c.p. brass.

CR

CROMOTERAPIA
COLOR THERAPYSOFFIONI
SHOWER HEADBOCCHE
SPOUTSBOX INCASSO
BUILT-IN BOXINCASSI
BUILT-INTHERMOSTATICI
THERMOSTATICSSET DOCCIA
SHOWER SETPANNELLI DOCCIA
SHOWER PANELSCOLONNE DOCCIA
SHOWER COLUMNSSALISCENDI
SLIDING RAILSDOCCETTE
HAND SHOWERS

SHUFOFF

SET PER BORDO VASCA
DECK MOUNTED BATH TUB SET





SALISCENDI SLIDING RAILS

CROMOTERAPIA
COLOR THERAPY

SOFFIONI
SHOWER HEAD

BOCCHE
SPOUTS

BOX INCASSO
BUILT-IN BOX

INCASSI
BUILT-IN

TERMOSTATICI
THERMOSTATICS

SET DOCCIA
SHOWER SET

PANNELLI DOCCIA
SHOWER PANELS

COLONNE DOCCIA
SHOWER COLUMNS

SALISCENDI
SLIDING RAILS

DOCCETTE
HAND SHOWERS

SHUFOFF

SET PER BORDO VASCA
DECK MOUNTED BATH TUB SET

KIT DOCCIA CON SALISCENDI SHOWER KIT WITH SLIDING RAIL



760RB

Kit composto da: asta saliscendi L. 90 cm con doccetta in ABS a 3 funzioni Ø 13 cm, flessibile PVC 150 cm.

Kit including: 90 cm shower rail with Ø 13 cm and 3-function ABS hand shower, 150 cm PVC flexible hose.

CR



76ED9

Kit composto da: asta saliscendi cromata con doccetta a 4 funzioni con pulsante per il cambio dei getti, in abs cromato (191MP); flessibile 150 cm.

Kit including: c.p. sliding rail with 4-function hand shower with button for changing the jets, abs, anti-limescale (191MP); 150 cm flexible hose.

CR



760PA

Kit composto da: saliscendi piatto in ottone con doccetta rettangolare piatta a 1 funzione, in ottone (191D9); flessibile 150 cm con sistema anti-torsione.

Kit including: brass flat sliding rail with 1-function flat rectangular hand shower, in brass (191D9); 150 cm flexible hose with anti-twist system.

CR



761TS

Kit composto da: saliscendi in ottone cromato con doccetta a 1 funzione, in ottone (191TS); flessibile 150 cm con sistema anti-torsione.

Kit including: brass sliding rail with 1-function brass hand shower (191TS); 150 cm flexible hose with anti-twist system.

CR



760RP

Kit composto da: asta saliscendi L. 70 cm con doccetta in ABS a 3 funzioni Ø 10 cm, flessibile anti-torsione 150 cm.

Kit including: 70 cm shower rail with Ø 10 cm and 3-function ABS hand shower, 150 cm anti-twist flexible hose.

CR



760TD

Kit composto da: asta saliscendi L. 65 cm con doccetta in ABS a 3 funzioni, porta sapone, flessibile PVC 150 cm.

Kit including: 65 cm shower rail with 3-function ABS hand shower, soap holder and 150 cm PVC flexible hose.

CR

**760CT**

Kit composto da: asta saliscendi L. 65 cm con doccetta a 2 funzioni: getto a pioggia e cascata, porta sapone, flessibile PVC 150 cm.

Kit including: 65 cm shower rail with 2-function hand shower: rain and waterfall effect, soap holder, 150 cm PVC flexible hose.

CR

**760EN**

Kit composto da: asta saliscendi L. 70 cm con asta rinforzata anticaduta e doccetta a 6 funzioni, flessibile PVC 150 cm.

Kit including: 70 cm shower rail with reinforced rod for anti-fall handle, 6-function hand shower, 150 cm PVC flexible hose.

CR



Supporti a muro in ottone e asta con funzione di maniglione di sostegno.
Brass wall rail-holder and rail with leaning function.

**760PS**

Kit composto da: asta saliscendi L.70 cm con doccetta a 3 getti, porta sapone, flessibile 150 cm.

Kit including: 70 cm shower rail with 3-function hand shower, soap holder, 150 cm flexible hose.

CR

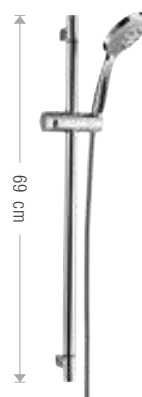
**760RE**

Kit composto da: asta saliscendi cromata con doccetta a 3 funzioni in ABS, Ø 10 cm; flessibile 150 cm con sistema anti-torsione.

Kit including: c.p. sliding rail with 3-function ABS hand shower, Ø 10 cm; 150 cm flexible hose with anti-twist system.

CR

**760AT**

Kit composto da: asta saliscendi cromata con doccetta a 1 funzione in ABS cromato, Ø 10 cm (191ID); flessibile 150 cm.

Kit including: c.p. sliding rail with 1-function hand shower in c.p. abs, Ø 10 cm (191ID); 150 cm flexible hose.

CR

**760NO**

Kit composto da: asta saliscendi cromata con doccetta arcuata a 1 funzione in abs cromato con getti in silicone (191NO); flessibile 150 cm.

Kit including: c.p. sliding rail with 1-function curved hand shower in c.p. abs with silicone jets (191NO); 150 cm flexible hose.

CR

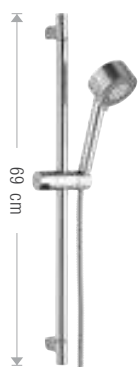

76BD2

Kit composto da: asta saliscendi cromata con doccetta a 4 funzioni in abs cromato con getti in silicone; flessibile 150 cm.
Kit including: c.p. sliding rail with 4-function hand shower in chromed abs with silicone jets; 150 cm flexible hose.

CR



76AD1

Kit composto da: asta saliscendi cromata con doccetta cromata a 5 funzioni con getti in silicone; flessibile 150 cm.
Kit including: c.p. sliding rail with 5-function abs hand shower with silicone jets; 150 cm flexible hose.

CR



76AD3

Kit composto da: asta saliscendi cromata con doccetta cromata a 1 funzione con getti in silicone; flessibile 150 cm.
Kit including: c.p. sliding rail with 1-function hand shower in c.p. abs with silicone jets; 150 cm flexible hose.

CR

CON OPZIONI DI FINITURA – WITH FINISHING OPTIONS



760PF

Kit composto da: saliscendi squadrato in ottone con doccetta minimale quadrata a 1 funzione, in ottone (191PF); flessibile 150 cm con sistema anti-torsione.
Kit including: brass squared sliding rail with 1-function squared hand shower, in brass (191PF); 150 cm flexible hose with anti-twist system.

CR

FN (.14 .37 . 08)



760UM

Kit composto da: asta saliscendi in ottone con doccetta a 1 funzione in ottone cromato (191D6); flessibile 150 cm.
Kit including: brass sliding rail with 1-function brass hand shower (191D6); 150 cm flexible hose.

CR

FN (.14 .37 . 08)

KIT SALISCENDI CON PRESA ACQUA INTEGRATA SLIDING RAIL KIT WITH WALL WATER CONNECTION

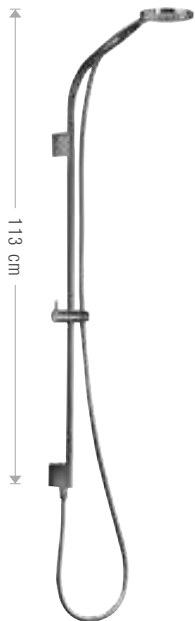

76CID

Colonna doccia saliscendi con asta Ø 20 mm e doppio supporto per doccetta: fisso superiore e scorrevole sull'asta. Completa di doccetta in ABS 1 getto Ø 13 cm, flessibile argento 1,5 m e presa acqua integrata nel supporto inferiore dell'asta.

Altezza colonna: 1,13 m.

Shower column with sliding rail Ø 20 mm and double holder for shower: fix on the upper part and sliding on the rail. Complete with 1 jet ABS shower Ø 13 cm, silver flexible 1.5 m and connecting pipe included in the lower part of the rail.

Column height: 1.13 m.

CR

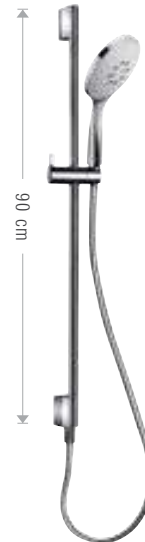

76BID

Asta saliscendi Independent L. 90 cm con doccetta in ABS Ø 13 cm 3 getti, flessibile argento 1,5 m e presa acqua integrata nel supporto inferiore dell'asta.

Independent sliding rail L. 90 cm with ABS Ø 13 cm 3 jets shower, silver flexible 1.5 m and connecting pipe included in the lower part of the rail.

CR



760ID

Asta saliscendi Independent L. 70 cm con doccetta in ABS cromata Ø 10 cm 1 getto, flessibile argento 1,5 m e presa acqua integrata nel supporto inferiore dell'asta.

Independent sliding rail L. 70 cm with chromed ABS Ø 10 cm 1 jet shower, silver flexible 1.5 m and connecting pipe included in the bottom part of the rail.

CR



76AID

Asta saliscendi Independent L. 90 cm con doccetta in ABS cromata Ø 13 cm 1 getto, flessibile argento 1,5 m e presa acqua integrata nel supporto inferiore dell'asta.

Independent sliding rail L. 90 cm with chromed ABS Ø 13 cm 1 jet shower, silver flexible 1.5 m and connecting pipe included in the lower part of the rail.

CR

CROMOTERAPIA
COLOR THERAPY

SOFFIONI
SHOWER HEAD

BOCCHE
SPOUTS

BOX INCASSO
BUILT-IN BOX

INCASSI
BUILT-IN

TERMOSTATICI
THERMOSTATICS

SET DOCCIA
SHOWER SET

PANNELLI DOCCIA
SHOWER PANELS

COLONNE DOCCIA
SHOWER COLUMNS

SALISCENDI
SLIDING RAILS

DOCCETTE
HAND SHOWERS

SHUOFF

SET PER BORDO VASCA
DECK MOUNTED BATH TUB SET





DOCCETTE HAND SHOWERS

CROMOTERAPIA
COLOR THERAPY

SOFFIONI
SHOWER HEAD

BOCCHE
SPOUTS

BOX INCASSO
BUILT-IN BOX

INCASSI
BUILT-IN

TERMOSTATICI
THERMOSTATICS

SET DOCCIA
SHOWER SET

PANNELLI DOCCIA
SHOWER PANELS

COLONNE DOCCIA
SHOWER COLUMNS

SALISCENDI
SLIDING RAILS

DOCCETTE
HAND SHOWERS

SHUFOFF

SET PER BORDO VASCA
DECK MOUNTED BATH TUB SET



191D9

Doccia in ottone flat 1 getto.
Brass 1 jet flat handshower.

CR



191QD

Doccia "Quadra" 1 getto in ABS
interamente cromata.
c.p. ABS 1 jet "Quadra" handshower.

CR



191HR

Doccia "Herm s" 1 getto in ABS
interamente cromata.
c.p. ABS 1 jet "Herm s" handshower.

CR



191AID

Doccia "Independent" in ABS cromato Ø 13
cm 1 getto.
"Independent" c.p. ABS Ø 13 cm 1 jet
handshower.

CR



191ID

Doccia "Independent" in ABS cromato Ø 10
cm 1 getto.
"Independent" c.p. ABS Ø 10 cm 1 jet
handshower.

CR



191NO

Doccia "Noir" in ABS 1 getto.
ABS 1 jet "Noir" handshower.

CR



191D8

Doccia in ABS 4 funzioni con pulsante
cambio getti, anticalcare.
ABS 4 jets handshower, anti-limestone,
with button to change jets.

CR



191TD

Doccia "Trendy" in ABS 3 getti.
ABS 3 jets "Trendy" handshower.

CR



191CT

Doccia a "Cascata" in ABS 2 getti.
ABS 2 jets "Cascata" handshower.

CR



191D4

Doccia in ABS 5 getti.
ABS 5 jets handshower.

CR

**19BID**

Doccia "Independent" in ABS Ø 13 cm 3 getti.
"Independent" ABS Ø 13 cm 3 jets
handshower.

CR

**75830**

Doccia "Extra" in ABS 5 getti.
ABS 5 jets "Extra" handshower.

CR

**191MP**

Doccetta cromata a 4 funzioni pulsante
per il cambio dei getti, con getti in silicone,
anticalcare.

C.p. handshower 4 functions with button to
change the jets, antilimestone with silicon
jets.

CR

**14191MP**

Doccetta a 4 funzioni, **nero opaco**
pulsante per il cambio dei getti, con getti
in silicone, anticalcare.

Handshower 4 functions, **matt black** with
button to change the jets, antilimestone
with silicon jets.

CR

**191TS**

Doccia "Tradition" in ottone 1 getto.
Brass 1 jet "Tradition" handshower.

CR

CON OPZIONI DI FINITURA – WITH FINISHING OPTIONS

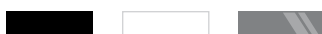
**191PF**

Doccia in ottone "Panfilo" 1 getto.
Brass 1 jet "Panfilo" handshower.

CR

FIN (.14 .37 .08)

**191D6**

Doccia "Herm s" 1 getto in ottone.
Brass 1 jet "Herm s" handshower.

CR

FIN (.14 .37 .08)

CROMOTERAPIA
COLOR THERAPYSOFFIONI
SHOWER HEADBOCCHE
SPOUTSBOX INCASSO
BUILT-IN BOXINCASSI
BUILT-INTERMOSTATICI
THERMOSTATICSSET DOCCIA
SHOWER SETPANNELLI DOCCIA
SHOWER PANELSCOLONNE DOCCIA
SHOWER COLUMNSSALSCENDI
SLIDING RAILSDOCCETTE
HAND SHOWERS

SHUOFF

SET PER BORDO VASCA
DECK MOUNTED BATH TUB SET

KIT DOCCETTA CON PRESA ACQUA HANDSHOWER KIT WITH WATER INLET



241PW

Kit composto da: doccetta rettangolare piatta a 1 funzione, in ottone (191D9); presa acqua a muro con supporto snodato (242QD); flessibile 150 cm con sistema anti-torsione.

Kit including: 1-function flat rectangular hand shower, in brass (191D9); w a l l connection pipe with adjustable shower holder (242QD); 150 cm flexible hose with anti-twist system.

CR



241PA

Kit composto da: doccetta a 1 funzione in abs cromato (191QD); presa acqua a muro con supporto snodato (242QD); flessibile 150 cm con sistema anti-torsione.

Kit including: 1-function hand shower in c.p. abs (191QD); wall connection pipe with adjustable shower holder (242QD); 150 cm flexible hose with anti-twist system.

CR



241PF

Kit composto da: doccetta minimale quadrata a 1 funzione, in ottone (191PF); presa acqua a muro con supporto snodato (242QD); flessibile 150 cm con sistema anti-torsione.

Kit including: 1-function squared hand shower, in brass (191PF); wall connection pipe with adjustable shower holder (242QD); 150 cm flexible hose with anti-twist system.

CR



243PW

Kit composto da: doccetta rettangolare piatta a 1 funzione, in ottone (191D9); presa acqua con supporto fisso (242PA); flessibile 150 cm con sistema anti-torsione.

Kit including: 1-function flat rectangular hand shower, in brass (191D9); brass connection pipe with shower holder (242PA); 150 cm flexible hose with anti-twist system.

CR



243PA

Kit composto da: doccetta a 1 funzione in abs cromato (191QD); presa acqua con supporto fisso (242PA); flessibile 150 cm con sistema anti-torsione.

Kit including: 1-function hand shower in c.p. abs (191QD); brass connection pipe with shower holder (242PA); 150 cm flexible hose with anti-twist system.

CR



241HR

Kit composto da: doccetta a 1 funzione in abs cromato (191HR); presa acqua a muro con supporto fisso (242MN); flessibile 150 cm con sistema anti-torsione.

Kit including: 1-function hand shower in c.p. abs (191HR); wall connection pipe with shower holder (242MN); 150 cm flexible hose with anti-twist system.

CR



241NO

Kit composto da: doccetta arcuata a 1 funzione in abs cromato con getti in silicone (191NO); presa acqua a muro con supporto fisso (242MN); flessibile 150 cm con sistema anti-torsione.

Kit including: 1-function curved hand shower in c.p. abs with silicone jets (191NO); wall connection pipe with shower holder (242MN); 150 cm flexible hose with anti-twist system.

CR



24AID

Kit composto da: doccetta a 1 funzione in abs (19AID); presa acqua a muro con supporto fisso (242MN); flessibile 150 cm con sistema anti-torsione.

Kit including: 1-function abs hand shower (19AID); wall connection pipe with shower holder (242MN); 150 cm flexible hose with anti-twist system.

CR



241UM

CON OPZIONI DI FINITURA – WITH FINISHING OPTIONS

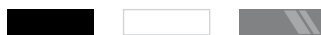
**243PF**

Kit composto da: doccetta minimale quadrata a 1 funzione, in ottone (191PF); presa acqua con supporto fisso (242PA); flessibile 150 cm con sistema anti-torsione. Kit including: 1-function squared hand shower, in brass (191PF); brass connection pipe with shower holder (242PA); 150 cm flexible hose with anti-twist system.

CR

FIN (.14.37.08)

**241UM**

Kit composto da: doccetta a 1 funzione in ottone cromato (191D6); presa acqua a muro con supporto fisso (242MN); flessibile 150 cm con sistema anti-torsione.

Kit including: 1-function brass hand shower (191D6); wall connection pipe with shower holder (242MN); 150 cm flexible hose with anti-twist system.

CR

FIN (.14.37.08)

CROMOTERAPIA
COLOR THERAPYSOFFIONI
SHOWER HEADBOCCHE
SPOUTSBOX INCASSO
BUILT-IN BOXINCASSI
BUILT-INTERMOSTATICI
THERMOSTATICSSET DOCCIA
SHOWER SETPANNELLI DOCCIA
SHOWER PANELSCOLONNE DOCCIA
SHOWER COLUMNSSALSCENDI
SLIDING RAILSDOCCETTE
HAND SHOWERSSET PER BORDO VASCA
DECK MOUNTED BATH TUB SET

SHUOFF

KIT DOCCETTA CON SUPPORTO HANDSHOWER KIT WITH SHOWER HOLDER



240PF

Kit composto da: doccetta minimale quadrata a 1 funzione, in ottone (191PF); supporto snodato in ABS cromato per flessibile con attacco conico; flessibile 150 cm con sistema anti-torsione.

Kit including: 1-function squared hand shower, in brass (191PF); adjustable shower holder in c.p. ABS; 150 cm flexible hose with anti-twist system.

CR



240QD

Kit composto da: doccetta a 1 funzione in abs cromato (191QD); supporto snodato in ABS cromato per flessibile con attacco conico; flessibile 150 cm con sistema anti-torsione.

Kit including: 1-function hand shower in c.p. abs (191QD); adjustable shower holder in c.p. ABS; 150 cm flexible hose with anti-twist system.

CR



240HR

Kit composto da: doccetta a 1 funzione in abs cromato (191HR); supporto snodato orientabile in ABS cromato; flessibile 150 cm con sistema anti-torsione.

Kit including: 1-function hand shower in c.p. abs (191HR); adjustable shower holder in c.p. ABS; 150 cm flexible hose with anti-twist system.

CR



240RE

Kit composto da: doccetta a 3 funzioni in ABS, Ø 10 cm; supporto snodato orientabile in ABS cromato; flessibile 150 cm con sistema anti-torsione.

Kit including: 3-function ABS hand shower, Ø 10 cm; adjustable shower holder in c.p. ABS; 150 cm flexible hose with anti-twist system.

CR



240NO

Kit composto da: doccetta arcuata a 1 funzione in abs cromato con getti in silicone (191NO); supporto snodato orientabile in ABS cromato; flessibile 150 cm con sistema anti-torsione.

Kit including: 1-function curved hand shower in c.p. abs with silicone jets (191NO); adjustable shower holder in c.p. ABS; 150 cm flexible hose with anti-twist system.

CR



240ID

Kit composto da: doccetta a 1 funzione in ABS cromato, Ø 10 cm (191ID); supporto snodato orientabile in ABS cromato; flessibile 150 cm con sistema anti-torsione.

Shower set "Independent" with ABS Ø10 cm 1 jet handshower and adjustable shower holder in ABS, 150 cm flexible hose.

CR



240TS

Kit composto da: doccetta a 1 funzione, in ottone (191TS); supporto snodato; flessibile 150 cm con sistema anti-torsione.

Kit including: 1-function brass hand shower (191TS); adjustable shower holder; 150 cm flexible hose with anti-twist system.

CR

PRESE ACQUA CONNECTION PIPES



752PA

Attacco presa acqua quadrato da 1/2" in ottone per flessibile doccia.
Squared angular brass connection pipe 1/2" for shower hose.

CR



752

Raccordo ad angolo da 1/2" per flessibile doccia.
Angular connection pipe 1/2" for shower hose.

CR



242PA

Presa acqua con supporto fisso in ottone per doccia e attacco da 1/2" per flessibile.
Connection pipe with c.p. brass shower holder and 1/2" connection for shower hose.

CR



752NO

Attacco presa acqua tondo da 1/2" in ottone per flessibile doccia.
Round angular brass connection pipe 1/2" for shower hose.

CR



242QD

Presa acqua con supporto snodato in ottone per doccia e attacco da 1/2" per flessibile.
Imballo in blister.
Connection pipe with c.p. brass squared adjustable shower holder and 1/2" connection for shower hose.
Blister packed.

CR



242MN

Presa acqua con supporto fisso in ottone per doccia e attacco da 1/2" per flessibile.
Imballo in blister.
Connection pipe with c.p. brass shower holder and 1/2" connection for shower hose.
Blister packed.

CR

CROMOTERAPIA
COLOR THERAPY

SOFFIONI
SHOWER HEAD

BOCCHE
SPOUTS

BOX INCASSO
BUILT-IN BOX

INCASSI
BUILT-IN

TERMOSTATICI
THERMOSTATICS

SET DOCCIA
SHOWER SET

PANNELLI DOCCIA
SHOWER PANELS

COLONNE DOCCIA
SHOWER COLUMNS

SALISCENDI
SLIDING RAILS

DOCCETTE
HAND SHOWERS

SHUFOFF

SET PER BORDO VASCA
DECK MOUNTED BATH TUB SET

FLESSIBILI DOCCIA — SHOWER FLEXIBLE HOSES



Flessibile doccia in PVC atossico con piattina cromata, attacco conico.
Flexible hose for shower in atoxic PVC and chrome flat wire inside all around, with one conical nut.

W002090400 120cm

W002039200 150cm

W002148800 200cm



Flessibile doccia in PVC atossico con piattina cromata, attacco conico.
Flexible hose for shower in atoxic PVC and chrome flat wire inside all around, with one conical nut.

W002118000 120cm

W002099900 150cm

W002089300 200cm



Flessibile doccia in PVC atossico con piattina cromata, attacco conico.
Flexible hose for shower in atoxic PVC and chrome flat wire inside all around, with one conical nut.

H00148FY120 120cm

H00148FY150 150cm

H00148FY200 200cm



Flessibile doccia in PVC atossico con piattina cromata, attacco conico.
Flexible hose for shower in atoxic PVC and chrome flat wire inside all around, with one conical nut.

H00148HY120 120cm

H00148HY150 150cm

H00148HY200 200cm



Flessibile doccia in PVC atossico con piattina cromata, attacco conico.
Flexible hose for shower in atoxic PVC and chrome flat wire inside all around, with one conical nut.

B001480G120 120cm

B001480G150 150cm

B001480G200 200cm



Flessibile per doccia retinato metallizzato in pvc atossico, con attacco doppio brillante conico, nero opaco.
Flexible hose for shower with net working metal colour, in atoxic pvc, with double conical shiny brilliant nut, matt black.

B141480G120 120cm

B141480G150 150cm



Flessibile per doccia retinato metallizzato in pvc atossico, con attacco doppio brillante conico, bianco opaco.
Flexible hose for shower with net working metal colour, in atoxic pvc, with double conical shiny brilliant nut, matt white.

B371480G120 120cm

B371480G150 150cm



Flessibile per doccia retinato metallizzato in pvc atossico, con attacco doppio brillante conico, nichel spazzolato opaco.
Flexible hose for shower with net working metal colour, in atoxic pvc, with double conical shiny brilliant nut, matt brushed nickel.

B671480G120 120cm

B671480G150 150cm



Flessibile per doccia retinato metallizzato in pvc atossico, con attacco doppio brillante conico, oro.
Flexible hose for shower with net working metal colour, in atoxic pvc, with double conical shiny brilliant nut, gold.

B011480G120 120cm

B011480G150 150cm



Flessibile per doccia retinato metallizzato in pvc atossico, con attacco doppio brillante conico, nichel spazzolato.
Flexible hose for shower with net working metal colour, in atoxic pvc, with double conical shiny brilliant nut, brushed nickel.

B081480G120 120cm

B081480G150 150cm

CROMOTERAPIA
COLOR THERAPYSOFFIONI
SHOWER HEADBOCCHE
SPOUTSBOX INCASSO
BUILT-IN BOXINCASSI
BUILT-INTHERMOSTATICI
THERMOSTATICSSET DOCCIA
SHOWER SETPANNELLI DOCCIA
SHOWER PANELSCOLONNE DOCCIA
SHOWER COLUMNSSALISCENDI
SLIDING RAILSDOCCETTE
HAND SHOWERS

SHUFOFF

SET PER BORDO VASCA
DECK MOUNTED BATH TUB SET





SHUT-OFF E IDROSCOPINI SHUT-OFF & HYDROBRUSH

CROMOTERAPIA
COLOR THERAPYSOFFIONI
SHOWER HEADBOCCHE
SPOUTSBOX INCASSO
BUILT-IN BOXINCASSI
BUILT-INTERMOSTATICI
THERMOSTATICSSET DOCCIA
SHOWER SETPANNELLI DOCCIA
SHOWER PANELSCOLONNE DOCCIA
SHOWER COLUMNSSALISCENDI
SLIDING RAILSDOCCETTE
HAND SHOWERS

SHUTOFF

SET PER BORDO VASCA
DECK MOUNTED BATH TUB SET

SHUT-OFF

Nota: questi prodotti sono dedicati all'igiene personale e non svolgono la funzione di idro-scopino.
 Note: these products are dedicated to personal hygiene and do not perform the function of hydro-toilet brush.

**14ADD**

Miscelatore incasso per shut-off comprensivo di doccetta shut-off, supporto doccia, presa-acqua su piastra in ottone cromato e flessibile doccia 120 cm.
 Built-in shut-off mixer set including shut-off handshower, shower holder, connection pipe on flange completely in c.p. brass and shower flexible 120 cm.

CR

**14ACB**

Miscelatore incasso comprensivo di doccetta shut-off, supporto doccia, presa-acqua su piastra in ottone cromato e flessibile doccia 120 cm.
 Built-in shower mixer set including shut-off handshower, shower holder, connection pipe on flange completely in c.p. brass and shower flexible 120 cm.

CR

**25ASF**

Monocomando esterno doccia con doccetta shut-off in ABS cromato, flessibile conico in ottone cromato 120 cm e gancio.

Wall mounted single-lever shower mixer with shut-off handshower in c.p. ABS, conical flexible in c.p. brass 120 cm and c.p. hook.

CR

CON OPZIONI DI FINITURA – WITH FINISHING OPTIONS

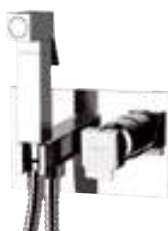
**14APA**

Miscelatore incasso per shut-off comprensivo di doccetta shut-off, supporto doccia, presa acqua su piastra in ottone cromato e flessibile doccia 120 cm.

Built-in shut-off mixer set including shut-off, shower holder, connection pipe on flange, completely in c.p. brass and shower flexible 120 cm.

CR

FIN (.14 .37 .08)

**14AUM**

Miscelatore incasso comprensivo di doccetta shut-off, supporto doccia, presa-acqua su piastra in ottone cromato e flessibile doccia 120 cm.

Built-in shower mixer set including shut-off handshower, shower holder, connection pipe on flange completely in c.p. brass and shower flexible 120 cm.

CR

FIN (.14 .37 .08)

**185PA**

Miscelatore incasso per shut-off comprensivo di doccetta shut-off, supporto doccia-presa acqua tutto in ottone cromato e flessibile doccia cm 120

Built-in shut-off mixer set including shut-off, shower holder-water punch all in c.p. brass and shower flexible 120 cm.

CR

FIN (.14 .37 .08)

**185NXW**

Miscelatore incasso per shut-off comprensivo di doccetta shut-off, supporto doccia, presa acqua, su piastra in ottone cromato e flessibile doccia da 120 cm.

Built-in shut-off mixer set including shutoff handshower, connection pipe on flange, completely in c.p. brass and shower flexible 120 cm.

CR

FIN (.14 .37 .08)

MONOACQUA – SINGLE WATER

**24BDD**

Set doccia shut-off composto da: doccetta a pulsante con supporto, rubinetto d'arresto con presa acqua e maniglia quadrata, flessibile cm. 120.

Imballo in blister.

Shut-off shower set composed of: handshower with support, stop valve with water connection and square handle, flexible cm 120.

Blister packed.

CR

**243DD**

Set doccia shut-off composto da: doccetta a pulsante con supporto, rubinetto d'arresto con presa acqua e maniglia minimale, flessibile cm. 120.

Imballo in blister.

Shut-off shower set composed of: handshower with support, stop valve with water connection and minimal handle, flexible cm 120.

Blister packed.

CR

**24EHF**

Set doccia shut-off comprensivo di doccetta shut-off, rubinetto d'arresto con supporto doccia quadrato in ottone e flessibile cm 120.

Shut-off shower set including shut-off, brass squared angle valve with shower holder, flexible cm 120.

CR

**24FHf**

Set doccia shut-off comprensivo di doccetta shut-off, rubinetto d'arresto con supporto doccia minimale in ottone e flessibile cm 120.

Shut-off shower set including shut-off, brass round angle valve with shower holder, flexible cm 120.

CR

**24CDD**

Set doccia shut-off composto da: doccetta a pulsante con supporto, rubinetto d'arresto con presa acqua e maniglia minimale, flessibile cm 120.

Shut-off shower set composed of: handshower with support, stop valve with water connection and minimal handle, flexible cm 120.

CR

**24ADD**

Set doccia shut-off composto da: doccetta a pulsante con supporto, rubinetto d'arresto con presa acqua e maniglia 3 punte, flessibile cm 120.

Shut-off shower set composed of: handshower with support, stop valve with water connection and 3 points handle, flexible cm 120.

CR

CON OPZIONI DI FINITURA – WITH FINISHING OPTIONS

**248NX**

Set composto da: doccetta a pulsante, flessibile con attacco conico cm 120, rubinetto ad angolo con vitone ceramico e supporto doccia in ottone.

Set composed of: shut-off handshower, cm 120 flexible hose with one conical nut, angle valve with ceramic headwork and brass shower holder.

CR

FN (.14 .37 .08)

ON / OFF

**249PA**

Set composto da: doccetta a pulsante, flessibile con attacco conico cm 120, rubinetto ad angolo con vitone ceramico e supporto doccia in ottone.

Set composed of: shut-off handshower, cm 120 flexible hose with one conical nut, angle valve with ceramic headwork and brass shower holder.

CR

FN (.14 .37 .08)

ON / OFF

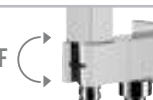

IDROSCOPINI – HYDRO BRUSH

**24BIS**

Set composto da: idroscopino, flessibile conico 120 cm, rubinetto ad angolo con maniglia quadrata e supporto doccia in ottone cromato.
Set composed of: hydro brush, conical flexible hose 120 cm, angle valve with squared handle and c.p. brass shower holder.

CR

**24AIS**

Set composto da: idroscopino, flessibile conico 120 cm, rubinetto ad angolo con maniglia minimale e supporto doccia in ottone cromato.
Set composed of: hydro brush, conical flexible hose 120 cm, angle valve with minimal handle and c.p. brass shower holder.

CR

CON OPZIONI DI FINITURA – WITH FINISHING OPTIONS

**248IS**

Set composto da: idroscopino a pulsante, flessibile con attacco conico cm 120 metallizzato in PVC, rubinetto ad angolo con vitone ceramico e supporto doccia in ottone.
Set including: push-button hydrobrush, 120 cm metallized PVC flexible hose with conical connection, angle tap with ceramic head valve and brass shower holder.

CR

FN (.14 .37 .08)

**249IS**

Set composto da: idroscopino a pulsante, flessibile con attacco conico cm 120 metallizzato in PVC, rubinetto ad angolo con vitone ceramico e supporto doccia in ottone.
Set including: push-button hydrobrush, 120 cm metallized PVC flexible hose with conical connection, corner tap with ceramic head valve and brass shower holder.

CR

FN (.14 .37 .08)

**24EIS**

Set composto da: idroscopino, flessibile conico 120 cm metallizzato in PVC, con maniglia quadrata e supporto doccia integrato.
Set composed of: hydro brush, PVC metallized conical flexible hose 120 cm, wall mtg. mixer with squared handle and integrated c.p. brass shower holder.

CR

FN (.14 .37 .08)

**24FIS**

Set composto da: idroscopino, flessibile conico 120 cm metallizzato in PVC, con maniglia minimale e supporto doccia integrato.
Set composed of: hydro brush, PVC metallized conical flexible hose 120 cm, wall mtg. mixer with minimal handle and integrated c.p. brass shower holder.

CR

FN (.14 .37 .08)



CROMOTERAPIA
COLOR THERAPY

SOFFIONI
SHOWER HEAD

BOCCHE
SPOUTS

BOX INCASSO
BUILT-IN BOX

INCASSI
BUILT-IN

TERMOSTATICI
THERMOSTATICS

SET DOCCIA
SHOWER SET

PANNELLI DOCCIA
SHOWER PANELS

COLONNE DOCCIA
SHOWER COLUMNS

SAISCENDI
SLIDING RAILS

DOCCETTE
HAND SHOWERS

SHUFOFF

SET PER BORDO VASCA
DECK MOUNTED BATH TUB SET

24FIS





SET PER BORDO VASCA DECK MOUNTED BATHTUB SET

CROMOTERAPIA
COLOR THERAPYSOFFIONI
SHOWER HEADBOCCHE
SPOUTSBOX INCASSO
BUILT-IN BOXINCASSI
BUILT-INTERMOSTATICI
THERMOSTATICSSET DOCCIA
SHOWER SETPANNELLI DOCCIA
SHOWER PANELSCOLONNE DOCCIA
SHOWER COLUMNSSALISCENDI
SLIDING RAILSDOCCETTE
HAND SHOWERS

SHUFOFF

SET PER BORDO VASCA
DECK MOUNTED BATHTUB SET

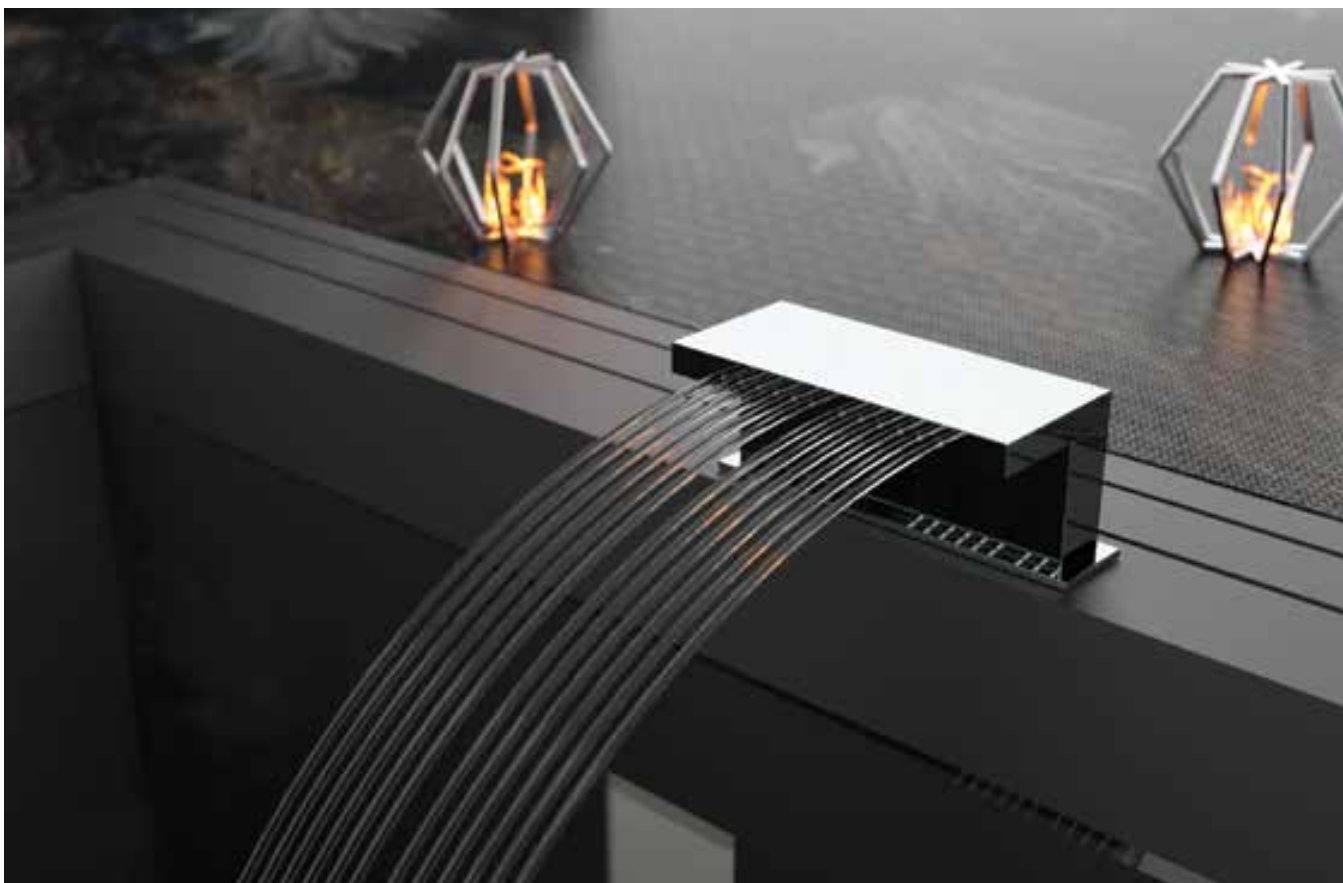

139N0

BOCCE PER BORDO VASCA DECK MOUNTED BATHTUB SPOUTS



139PA

Bocca bordo vasca con effetto fontana.
Spout with fountain effect for deck bath/
shower mixer.

CR



139N0

Bocca bordo vasca con effetto fontana.
Spout with fountain effect for deck bath/
shower mixer.

CR



138PA

Bocca bordo vasca a cascata.
Waterfall spout for deck bath/shower
mixer.

CR



139SF

Bocca bordo vasca a cascata.
Waterfall spout for deck bath/shower
mixer.

CR

SET PER BORDO VASCA DECK MOUNTED BATHTUB SET

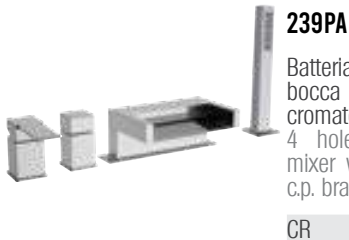
**239PA**

Batteria bordo vasca 4 fori con deviatore, bocca a cascata e doccetta in ottone cromato.
4 holes deck mounted bath/shower mixer with diverter, waterfall spout and c.p. brass handshower.

CR

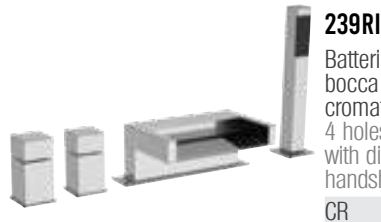
**239RI**

Batteria bordo vasca 4 fori con deviatore, bocca a cascata e doccetta in ottone cromato.
4 holes deck mounted bath/shower mixer with diverter, waterfall spout and c.p. brass handshower.

CR

**236PA**

Batteria bordo vasca 4 fori con deviatore, bocca con effetto fontana e doccetta in ottone cromato.
4 holes deck mounted bath/shower mixer with diverter, spout with fountain effect and c.p. brass handshower.

CR

**239CB**

Batteria bordo vasca 4 fori con deviatore, bocca con effetto fontana e doccetta in ottone cromato.
4 holes deck mounted bath/shower mixer with diverter, spout with fountain effect and c.p. brass handshower.

CR

**236NO**

Batteria bordo vasca 4 fori con deviatore, bocca con effetto fontana e doccetta in ABS cromato.
4 holes deck mounted bath/shower mixer with diverter, spout with fountain effect and c.p. ABS handshower.

CR

**237PA**

Batteria bordo vasca 3 fori. Doccetta in ottone.
3 holes bath shower mixer, handshower in brass.

CR

**237AT**

Batteria bordo vasca 3 fori.
3 holes bath shower mixer.

CR

**237HR**

Batteria bordo vasca 3 fori.
3 holes bath shower mixer.

CR

CROMOTERAPIA
COLOR THERAPYSOFFIONI
SHOWER HEADBOCCHE
SPOUTSBOX INCASSO
BUILT-IN BOXINCASSI
BUILT-INTHERMOSTATICI
THERMOSTATICSSET DOCCIA
SHOWER SETPANNELLI DOCCIA
SHOWER PANELSCOLONNE DOCCIA
SHOWER COLUMNSSALISCENDI
SLIDING RAILSDOCCETTE
HAND SHOWERS

SHUOFF

SET PER BORDO VASCA
DECK MOUNTED BATHTUB SET





DESIGN

DOCCETTA ESTRAIBILE – PULL-OUT HANDSHOWER

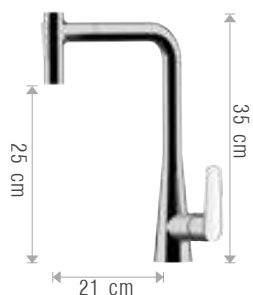
**591AR****ARMONIA**

Miscelatore monocomando per lavello, con canna alta girevole e doccetta estraibile con impugnatura a martello a due funzioni. Single-lever sink mixer with high swivel spout and 2-functions pull-out "hammer shaped" handle hand shower.

CR



DESIGN

TOUCH-HE

ACQUA DEPURATA
DRINKING WATER

BOCCA ALTA
HIGH NECK

BOCCA BASSA
LOW NECK

A PARETE
WALL MOUNT.

DOPPI COMANDI
DOUBLE HANDLE

591AR

DOCCETTA ESTRAIBILE – PULL-OUT HANDSHOWER



594AR

ARMONIA

Miscelatore monocomando per lavello con canna alta girevole e sistema di doccetta monofunzione estraibile.
Single-lever sink mixer with high swivel spout and 1-function pull-out hand shower.

CR



595AR

ARMONIA

Miscelatore monocomando per lavello con canna alta girevole e doccetta estraibile a due funzioni.
Single-lever sink mixer with high movable spout and 2-functions pull-out hand shower.

CR

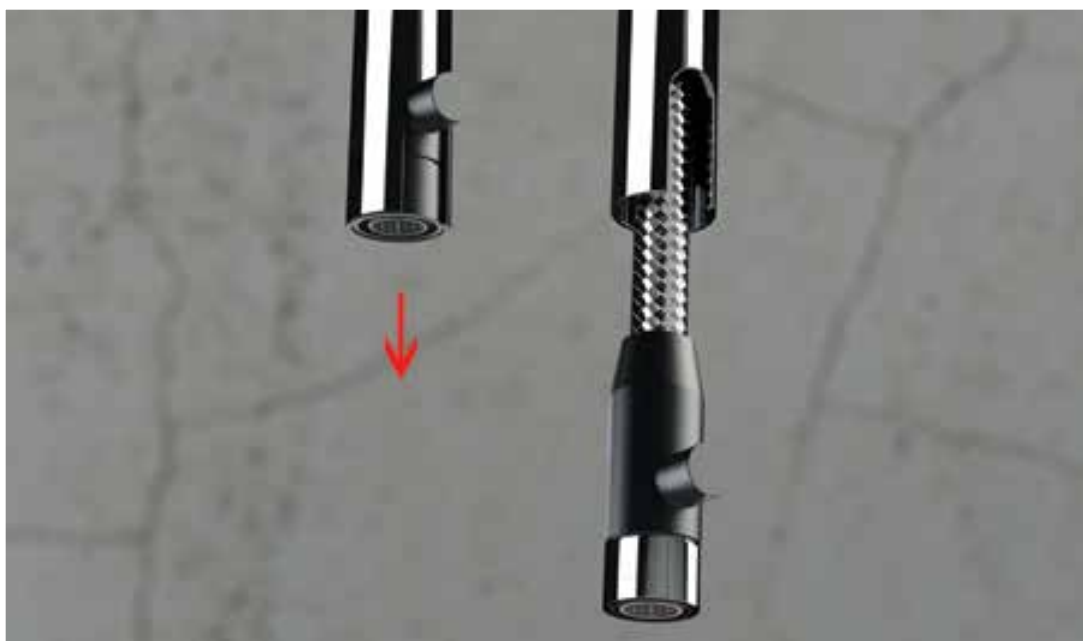



DESIGN

TOUCH-HE

ACQUA DEPURATA
DRINKING WATER

BOCCA ALTA
HIGH NECK

BOCCA BASSA
LOW NECK

A PARETE
WALL MOUNT.

DOPPI COMANDI
DOUBLE HANDLE

594AR



581SF **SURF**

Miscelatore monocomando per lavello, con canna alta girevole e doccetta estraibile con impugnatura a martello a due funzioni. Single-lever sink mixer with high swivel spout and 2-functions pull-out "hammer shaped" handle hand shower.

CR



DESIGN

TOUCH-HE

ACQUA DEPURATA
DRINKING WATER

BOCCA ALTA
HIGH NECK

BOCCA BASSA
LOW NECK

A PARETE
WALL MOUNT.

DOPPI COMANDI
DOUBLE HANDLE

581SF



584SF

SURF

Miscelatore monocomando per lavello, con canna alta girevole e sistema di doccia monofunzione estraibile.
Single-lever sink mixer with high swivel spout and 1-function pull-out hand shower.

CR

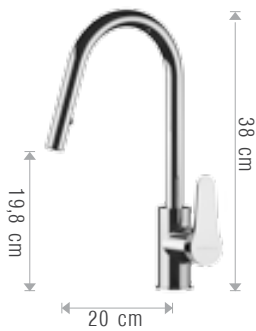

585SF

SURF

Miscelatore monocomando per lavello, con canna alta girevole e doccia estraibile a due funzioni.
Single-lever sink mixer with high swivel spout and 2-functions pull-out hand shower.

CR





DESIGN

TOUCH-AME

ACQUA DEPURATA
DRINKING WATER

BOCCA ALTA
HIGH NECK

BOCCA BASSA
LOW NECK

A PARETE
WALL MOUNT.

DOPPI COMANDI
DOUBLE HANDLE

585SF

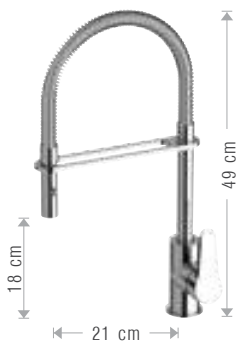

518SF4

Miscelatore lavello con flessibile bianco rivestito con molla "fine design", corpo principale e maniglia cromati.
Sink mixer with white flexible hose coated with "fine design" spring, chrome painted main body and handle.

CR



518SF3

Miscelatore lavello con flessibile nero rivestito con molla "fine design", corpo principale e maniglia cromati.
Sink mixer with black flexible hose coated with "fine design" spring, chrome painted main body and handle.

CR





DESIGN

TOUCH-AME

ACQUA DEPURATA
DRINKING WATER

BOCCA ALTA
HIGH NECK

BOCCA BASSA
LOW NECK

A PARETE
WALL MOUNT.

DOPPI COMANDI
DOUBLE HANDLE

518SF4



518SF5

Miscelatore lavello con flessibile rivestito in tubo gomma soft-touch bianco opaco. Sink mixer with flexible hose coated in soft-touch matt white rubber pipe.

CR

518SF6

Miscelatore lavello con flessibile rivestito in tubo gomma soft-touch bianco opaco con leva verniciata bianco opaco. Sink mixer with flexible hose coated in soft-touch matt white rubber pipe with matt white lever.

CR



518SF1

Miscelatore lavello con flessibile rivestito in tubo gomma soft-touch nero opaco. Sink mixer with flexible hose coated in soft-touch matt black rubber pipe.

CR

518SF2

Miscelatore lavello con flessibile rivestito in tubo gomma soft-touch nero opaco con leva verniciata nero opaco. Sink mixer with flexible hose coated in soft-touch matt black rubber pipe with matt black lever.

CR





DESIGN

TOUCH-HE

ACQUA DEPURATA
DRINKING WATER

BOCCA ALTA
HIGH NECK

BOCCA BASSA
LOW NECK

A PARETE
WALL MOUNT.

DOPPI COMANDI
DOUBLE HANDLE

518SF1

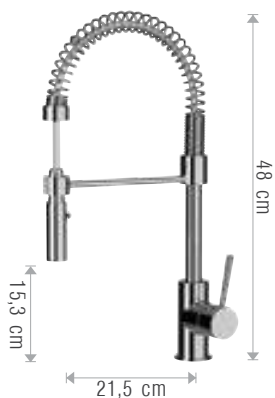

57DHR **HERM S**

Miscelatore monocomando lavello a molla con doccetta estraibile a 2 funzioni.
Single-lever sink mixer with spring spout and 2 functions pull-out handshower.

CR

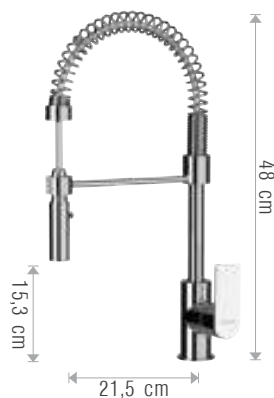

57DAV **AVENUE**

Miscelatore monocomando lavello a molla con doccetta estraibile a 2 funzioni.
Single-lever sink mixer with spring spout and 2 functions pull-out handshower.

CR

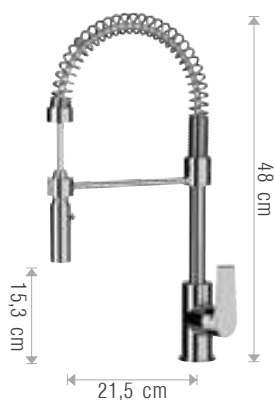

57DAT **ARTIC**

Miscelatore monocomando lavello a molla con doccetta estraibile dal supporto ed orientabile a due funzioni.
Spring single-lever sink mixer with pull-out and adjustable 2 functions handshower.

CR

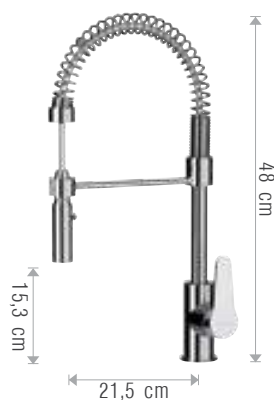

57DSF **SURF**

Miscelatore monocomando lavello a molla con doccetta estraibile dal supporto ed orientabile a due funzioni.
Spring single-lever sink mixer with pull-out and adjustable 2 functions handshower.

CR



DESIGN

TOUCH-AME

ACQUA DEPURATA
DRINKING WATER

BOCCA ALTA
HIGH NECK

BOCCA BASSA
LOW NECK

A PARETE
WALL MOUNT.

DOPPI COMANDI
DOUBLE HANDLE

57DAT

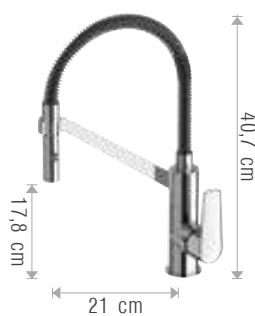

519AV3

AVENUE

Miscelatore monocomando lavello con flessibile nero rivestito con molla "fine design", girevole 360°, doccetta estraibile dal supporto ed orientabile a 2 funzioni.
 Single-lever sink mixer with black flexible hose coated with "fine design" spring, 360° movable, detachable and adjustable 2 functions handshower.

CR

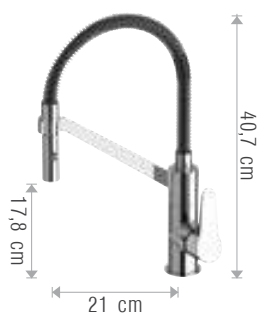

519SF3

SURF

Miscelatore monocomando lavello con flessibile nero rivestito con molla "fine design", girevole 360°, doccetta estraibile dal supporto ed orientabile a 2 funzioni.
 Single-lever sink mixer with black flexible hose coated with "fine design" spring, 360° movable, detachable and adjustable 2 functions handshower.

CR

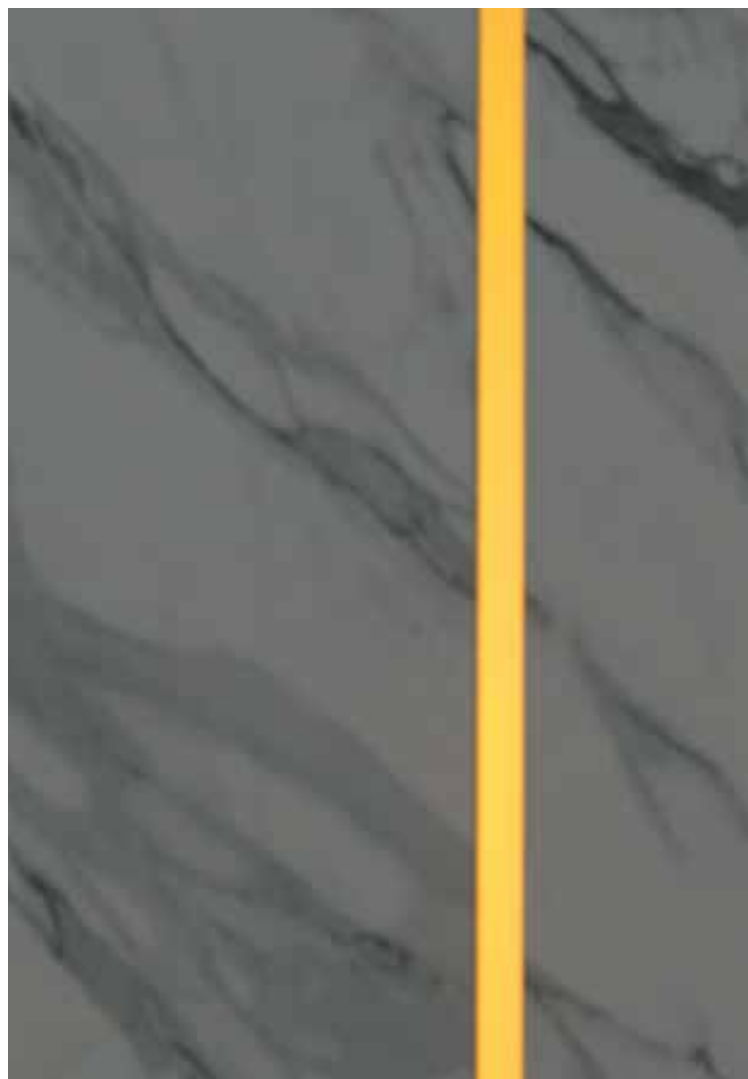



DESIGN

TOUCH-AME

ACQUA DEPURATA
DRINKING WATER

BOCCA ALTA
HIGH NECK

BOCCA BASSA
LOW NECK

A PARETE
WALL MOUNT.

DOPPI COMANDI
DOUBLE HANDLE

519SF3

LAVELLI GOURMET DESIGN — GOURMET DESIGN SINK MIXERS

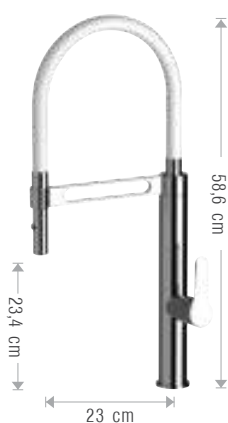
**516SF5**

Miscelatore lavello con flessibile rivestito in tubo gomma soft-touch bianco opaco. Sink mixer with flexible hose coated in soft-touch matt white rubber pipe.

CR

516SF6

Miscelatore lavello con flessibile rivestito in tubo gomma soft-touch bianco opaco, leva verniciata bianco opaco. Sink mixer with flexible hose coated in soft-touch matt white rubber pipe, matt white painted lever.

CR

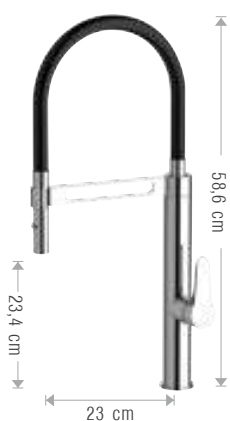
**516SF1**

Miscelatore lavello con flessibile rivestito in tubo gomma soft-touch nero opaco. Sink mixer with flexible hose coated in soft-touch matt white rubber pipe.

CR

516SF2

Miscelatore lavello con flessibile rivestito in tubo gomma soft-touch nero opaco, leva verniciata nero opaco. Sink mixer with flexible hose coated in soft-touch matt black rubber pipe, matt black painted lever.

CR





DESIGN

TOUCH-AME

ACQUA DEPURATA
DRINKING WATER

BOCCA ALTA
HIGH NECK

BOCCA BASSA
LOW NECK

A PARETE
WALL MOUNT.

DOPPI COMANDI
DOUBLE HANDLE

516SF1

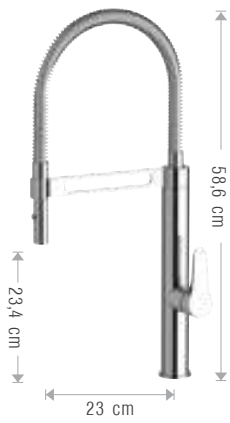

516SF4

Miscelatore lavello con flessibile bianco rivestito con molla "fine design".
Sink mixer with white flexible hose coated with "fine design" spring.

CR

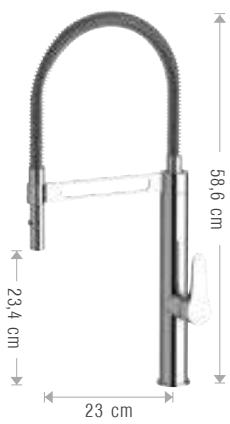

516SF3

Miscelatore lavello con flessibile nero rivestito con molla "fine design".
Sink mixer with black flexible hose coated with "fine design" spring.

CR





DOPPI COMANDI
DOUBLE HANDLE

A PARETE
WALL MOUNT.

BOCCA BASSA
LOW NECK

BOCCA ALTA
HIGH NECK

ACQUA DEPURATA
DRINKING WATER

TOUCH-HE

DESIGN





DESIGN

TOUCH-**ME**

ACQUA DEPURATA
DRINKING WATER

BOCCA ALTA
HIGH NECK

BOCCA BASSA
LOW NECK

A PARETE
WALL MOUNT.

DOPPI COMANDI
DOUBLE HANDLE

TOUCH-ME

TOUCH-ME una tecnologia di ultima generazione che permette di aprire e chiudere il flusso dell'acqua al solo tocco del miscelatore, senza quindi dover impugnare la leva di miscelazione, che conserva comunque intatte le sue funzioni di apertura, chiusura e regolazione della temperatura e flusso per l'utilizzo tradizionale.

I miscelatori TOUCH-ME portano un valore di grande innovazione all'interno delle vostre cucine.

Con i miscelatori per cucina TOUCH-ME di Rubinetterie Mariani infatti facile aprire e chiudere l'acqua anche con le mani impegnate o sporche, sar' sufficiente toccare la bocca o qualsiasi parte del rubinetto (leva esclusa) con, ad esempio, il polso, un dito, un cucchiaino se completamente in metallo o il bordo della pentola se completamente in metallo.

Tutte le operazioni di apertura e di chiusura dell'acqua diverranno quindi veloci, igieniche, senza sprechi e anche divertenti!

NOTE TECNICHE:

Facile installazione salvaspazio dell'elettronica sotto il lavello.

Non richiede tecnici specializzati, n' prese elettriche.

Alimentato da 4 batterie AA litio 1,5V (durevoli nel tempo, reperibili nei normali supermercati).

Il rubinetto con tecnologia TOUCH-ME potr' essere utilizzato in qualsiasi momento come un normale rubinetto, semplicemente scollegando la funzione TOUCH.

Ogni miscelatore cucina TOUCH-ME dotato di:

- Due elettrovalvole e rubinetti sottolavabo con filtro;
- Collegamento elettrico al rubinetto per il sensore TOUCH;
- Elettronica TOUCH-ME racchiusa in un apposito contenitore salva spazio con le 4 batterie.



506ATT

ARTIC

Miscelatore monocomando lavello, con canna alta girevole a "C" dotata di tecnologia "Touch-Me" con leva laterale. Single-lever sink mixer with high swivel "C" spout equipped with "Touch-Me" system with side lever.

CR



507ATT

ARTIC

Miscelatore monocomando lavello, con canna alta a gomito e girevole dotata di tecnologia "Touch-Me" con leva laterale. Single-lever sink mixer with cranking high swivel spout equipped with "Touch-Me" system with side lever.

CR



506SFT

SURF

Miscelatore monocomando lavello, con canna alta girevole a "C" dotata di tecnologia "Touch-Me" con leva laterale. Single-lever sink mixer with high swivel "C" spout equipped with "Touch-Me" system with side lever.

CR



507SFT

SURF

Miscelatore monocomando lavello, con canna alta a gomito e girevole dotata di tecnologia "Touch-Me" con leva laterale. Single-lever sink mixer with cranking high swivel spout equipped with "Touch-Me" system with side lever.

CR

TOUCH-ME is a latest generation technology to open and close the water flow simply by touching the mixer. It is in fact possible to open and close the water even with busy or dirty hands, simply by touching the tap's surface with, for example, one finger, the forearm, the spoon (if completely in metal) or the edge of the pot (if completely in metal).

The lever keeps its function of selector and will need to be touched only for deciding temperature and flow.

TOUCH-ME mixer faucets bring a value of great innovation to your kitchen interiors, and using your mixer will become hygienic, water saving, easy and also fun!

TECHNICAL NOTES:

Easy space-saving installation of electronics under the sink.

Installation does not require specialized technicians or electrical outlets.

Powered by 4 AA 1.5V lithium (durable in time, available worldwide in normal shops).

Faucets with TOUCH-ME technology can also be used at any time as a normal tap, simply by disconnecting the TOUCH function.

Each TOUCH-ME kitchen mixer is equipped with:

- Two solenoid valves and two angle valves with filter;
- Electrical connection for the TOUCH sensor;
- TOUCH-ME electronic system protected in a special space-saving box including the 4 batteries.



DESIGN

TOUCH-AME

ACQUA DEPURATA
DRINKING WATER

BOCCA ALTA
HIGH NECK

BOCCA BASSA
LOW NECK

A PARETE
WALL MOUNT.

DOPPI COMANDI
DOUBLE HANDLE

506SFT





ACQUA DEPURATA DRINKING WATER

MISCELATORI PER ACQUA DEPURATA MIXER FOR PURIFIED WATER

Una collezione di miscelatori per la cucina di Rubinetterie Mariani con 3 o più vie di ingresso per gestire l'acqua filtrata in modo comodo, igienico ed elegante.

Integrando design e tecnologie è stato possibile creare modelli ad alta efficienza, con deviazione sia elettronica che meccanica, con percorsi di ingresso e d'uscita separati che dividono l'acqua corrente miscelata dall'acqua filtrata evitando che i due flussi entrino in contatto.

A kitchen mixers collection by Rubinetterie Mariani with 3 or more inlets to easily manage the filtered water in a comfortable, hygienic and elegant way.

By integrating design and technology it has been possible to create high-efficiency models, with both electronic and mechanical management, with separate inlet and outlet paths that divide the mixed water from the filtered one, preventing any contact between the two flows.

MISCELATORE ELETTRONICO ACQUA POTABILE O FRIZZANTE ELECTRONIC MIXER FOR DRINKING OR SPARKLING WATER

Nella versione elettronica, l'erogazione dell'acqua depurata viene attivata o interrotta con una leggera pressione dell'apposito pulsante, mentre la leva di miscelazione regola l'acqua non filtrata secondo la funzionalità tradizionale.

In the electronic version, the purified water supply is activated or interrupted by lightly pressing the appropriate button, while the mixing lever adjusts the unfiltered water according to the traditional functionality.



D74UMTFDW

Miscelatore monocomando a 3+2 vie con tastiera elettronica di selezione per gestire fino a 3 ingressi (ad esempio depurata, frizzante e rinfrescata) e canna girevole. Da collegare agli appositi apparecchi di depurazione, gassificazione e/o filtri. La tastiera elettronica permette di selezionare l'ingresso desiderato per poi attivare ed interrompere l'erogazione corrispondente. La leva di miscelazione regola invece l'acqua calda/fredda non filtrata secondo la funzionalità tradizionale. Alimentazione elettrica sottolavabo.

3+2 ways single-lever mixer with electronic keyboard selection to manage up to 3 inputs (for example purified, sparkling and refreshed) with swivable spout. To be connected to the appropriate purification, gasification devices and/or filters. The electronic keyboard allows to select the desired input and then to activate and to stop the corresponding water delivery. The mixing lever instead regulates the unfiltered hot/cold water according to traditional functionality. Under-sink electric power supply.

ULTRAMINIMAL

CR



DESIGN

TOUCH-AME

ACQUA DEPURATA
DRINKING WATER

BOCCA ALTA
HIGH NECK

BOCCA BASSA
LOW NECK

A PARETE
WALL MOUNT.

DOPPI COMANDI
DOUBLE HANDLE

D74UMTFDW

MISCELATORI A TRE VIE PER ACQUA DEPURATA 3 INLETS MIXER FOR PURIFIED WATER

I miscelatori a 3 vie per acqua depurata forniscono un terzo ingresso per gestire l'acqua proveniente da un depuratore.

La selezione dell'acqua desiderata avviene semplicemente ruotando il comando di deviazione che, a seconda del modello, può essere integrato nella bocca o sul corpo del miscelatore.

3-way mixers for purified water provide a third inlet to handle water from a purifier.

The selection of the desired water is done simply by turning the deviation control which, depending on the model, can be integrated in the spout or on the body of the mixer.

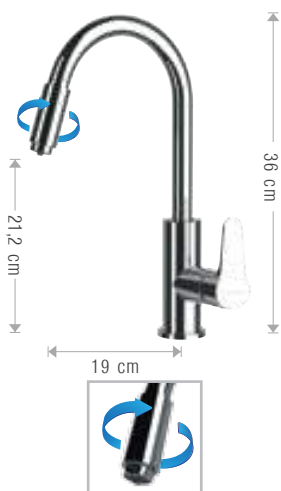

D71SFDW

SURF

Miscelatore monocomando a 3 vie con leva laterale con bocca girevole. È possibile selezionare tra acqua depurata o acqua miscelata tramite la rotazione della parte terminale della bocca di erogazione.

Due percorsi di ingresso separati dividono l'acqua miscelata dall'acqua filtrata e portano a due sezioni distinte dell'aeratore. 3 ways single-lever mixer with side lever with swivel spout. It is possible to select between purified water or mixed water by rotating the end part of the spout. Two separate inlets divide the mixed water from the filtered water and lead to two distinct sections of the aerator.

CR



560SF

SURF

Miscelatore lavello a tre vie di ingresso con bocca girevole, con selezione acqua potabile tramite la leva, con 2 vie d'uscita completamente indipendenti.

Three ways inlet single-lever sink mixer, with swivel spout, selection for drinking water directly from the lever, with 2 independent outlets.

CR



560UM

ULTRAMINIMAL

Miscelatore lavello a tre vie di ingresso con bocca girevole, con selezione acqua potabile tramite la leva, con 2 vie d'uscita completamente indipendenti.

Three ways inlet single-lever sink mixer, with swivel spout, selection for drinking water directly from the lever, with 2 independent outlets.

CR

TRE INGRESSI ED 1 USCITA 3 INLETS AND 1 OUTLET



D72E2

EPIC

Miscelatore lavello a tre vie di ingresso, con bocca girevole, con selezione acqua potabile tramite la leva, con 2 aeratori in uscita.

Three ways inlet single-lever sink mixer, with swivel spout, selection for drinking water directly from the lever, with 2 exit aerators.

CR



512E2AP

EPIC

Miscelatore monocomando lavello a tre vie con selettore per acqua potabile e canna girevole.

Single-lever sink mixer with diverter for selection drinking water and swivel spout.

CR



DESIGN

TOUCH-AME

ACQUA DEPURATA
DRINKING WATER

BOCCA ALTA
HIGH NECK

BOCCA BASSA
LOW NECK

A PARETE
WALL MOUNT.

DOPPI COMANDI
DOUBLE HANDLE

560SF





DESIGN

TOUCH-AME

ACQUA DEPURATA
DRINKING WATER

BOCCA ALTA
HIGH NECK

BOCCA BASSA
LOW NECK

A PARETE
WALL MOUNT.

DOPPI COMANDI
DOUBLE HANDLE

BOCCA ALTA HIGH NECK



597AR **ARMONIA**
Miscelatore monocomando lavello con
bocca alta a "U" girevole.
Single-lever sink mixer with high movable
"U" spout.

CR

DESIGN

TOUCHME

ACQUA DEPURATA
DRINKING WATER

BOCCA ALTA
HIGH NECK

BOCCA BASSA
LOW NECK

A PARETE
WALL MOUNT.

DOPPI COMANDI
DOUBLE HANDLE



596AR **ARMONIA**
 Miscelatore monocomando lavello con
 bocca alta a "C" girevole.
 Single-lever sink mixer with high movable
 "C" spout.

CR





570PA **POLAR**
 Miscelatore monocomando lavello bocca girevole.
 Single-lever sink mixer with swivel spout.

CR



570MA **MARTE**
 Miscelatore monocomando lavello bocca girevole.
 Single-lever sink mixer with swivel spout.

CR



570PA

- DESIGN
- TOUCH&ME
- ACQUA DEPURATA
DRINKING WATER
- BOCCA ALTA
HIGH NECK
- BOCCA BASSA
LOW NECK
- A PARETE
WALL MOUNT.
- DOPPI COMANDI
DOUBLE HANDLE



506AT **ARTIC**
 Miscelatore monocomando lavello, bocca alta girevole.
 Single-lever sink mixer with swivel high spout

CR



506HR **HERM S**
 Miscelatore monocomando lavello bocca alta girevole.
 Single-lever sink mixer with swivel high spout

CR



506AV **AVENUE**
 Miscelatore monocomando lavello, bocca girevole alta.
 Single-lever sink mixer with swivel high spout

CR



506SF **SURF**
 Miscelatore monocomando lavello, bocca girevole alta.
 Single-lever sink mixer with swivel high spout

CR



50AES **ESSENZA**
 Miscelatore monocomando lavello bocca girevole.
 Single-lever sink mixer with swivel high spout

CR



507HR **HERM S**
 Miscelatore monocomando lavello bocca girevole.
 Single-lever sink mixer with swivel spout

CR

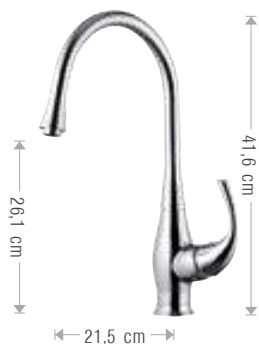

571PN PLUTO
 Miscelatore monocomando lavello bocca girevole.
 Single-lever sink mixer with swivel spout.

CR



506ES ESSENZA
 Miscelatore monocomando lavello bocca girevole.
 Single-lever sink mixer with swivel spout.

CR

DOCCETTA ESTRAIBILE – PULL-OUT HANDSHOWER



511PN PLUTO
 Miscelatore monocomando lavello bocca girevole doccia estraibile 2 getti.
 Single-lever sink mixer with swivel spout and 2 jets pull-out shower.

CR



511HR HERM S
 Miscelatore monocomando lavello bocca girevole e doccia estraibile, 2 getti.
 Single-lever sink mixer with swivel spout and pull-out shower, 2 jets.

CR



511HR

- DESIGN
- TOUCH-ME
- ACQUA DEPURATA
DRINKING WATER
- BOCCA ALTA
HIGH NECK
- BOCCA BASSA
LOW NECK
- A PARETE
WALL MOUNT.
- DOPPI COMANDI
DOUBLE HANDLE



571SFB **SURF**
 Miscelatore monocomando lavello, con canna alta girevole.
 Single-lever sink mixer with high movable spout
 CR



571ATB **ARTIC**
 Miscelatore monocomando lavello, con canna alta girevole.
 Single-lever sink mixer with high movable spout
 CR



57AE9 **EPIC**
 Miscelatore monocomando lavello con bocca alta girevole e leva clinica.
 Single-lever sink mixer with high swivel spout and clinical lever.
 CR



570ES **ESSENZA**
 Miscelatore monocomando lavello bocca girevole.
 Single-lever sink mixer with swivel spout.
 CR

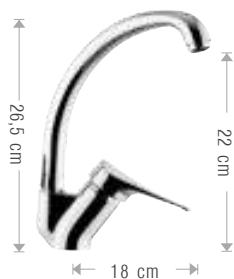

570MM **MAXIMA**
 Miscelatore monocomando lavello bocca girevole.
 Single-lever sink mixer with swivel spout.
 CR



57ASF **SURF**
 Miscelatore monocomando lavello **bocca fusa** girevole.
 Single-lever sink mixer with swivel **casted spout**.
 CR



570SF
 Miscelatore monocomando lavello bocca girevole.
 Single-lever sink mixer with swivel spout.
 CR



570E2 **EPIC**
 Miscelatore monocomando lavello **bocca fusa** girevole.
 Single-lever sink mixer with swivel **casted spout**.
 CR



570AT **ARTIC**
 Miscelatore monocomando lavello bocca girevole.
 Single-lever sink mixer with swivel spout.
 CR

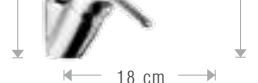

57AE2
 Miscelatore monocomando lavello con bocca alta girevole.
 Single-lever sink mixer with high swivel spout.
 CR



506E2 **EPIC**
 Miscelatore monocomando lavello bocca girevole.
 Single-lever sink mixer with swivel spout.

CR



571E2 **EPIC**
 Miscelatore monocomando lavello bocca girevole.
 Single-lever sink mixer with swivel spout.

CR

CUCINA SOTTOFINESTRA – UNDER WINDOW KITCHEN



510SF **SURF**
 Miscelatore monocomando lavello con bocca alta girevole abbattibile.
 Per sotto-finestra.
 Single-lever sink mixer with high foldable swivel spout. Under window model.

CR



510AT **ARTIC**
 Miscelatore monocomando lavello con bocca alta girevole abbattibile.
 Per sotto-finestra.
 Single-lever sink mixer with high foldable swivel spout. Under window model.

CR



510E2 **EPIC**
 Miscelatore monocomando lavello con bocca alta girevole abbattibile.
 Per sotto-finestra.
 Single-lever sink mixer with high foldable swivel spout. Under window model.

CR



510SFLT6C3 **SURF ECO**
 Miscelatore monocomando lavello con bocca alta girevole abbattibile, per sotto-finestra. Con cartuccia a risparmio energetico e limitatore di portata a 6 L/min.
 Single-lever sink mixer with movable swivel spout, under window model. Including energy saving cartridge and flow limiter at 6 L/min.

CR



DESIGN

TOUCHME

ACQUA DEPURATA
 DRINKING WATER

BOCCA ALTA
 HIGH NECK

BOCCA BASSA
 LOW NECK

A PARETE
 WALL MOUNT.

DOPPI COMANDI
 DOUBLE HANDLE





BOCCA BASSA LOW NECK

DESIGN

TOUCH-AME

ACQUA DEPURATA
DRINKING WATER

BOCCA ALTA
HIGH NECK

BOCCA BASSA
LOW NECK

A PARETE
WALL MOUNT.

DOPPI COMANDI
DOUBLE HANDLE

DOCGETTA ESTRAIBILE – PULL-OUT HANDSHOWER



511E9 **EPIC**
 Miscelatore monocomando lavello con leva clinica, bocca girevole e doccia estraibile 2 getti.
 Single-lever sink mixer with swivel spout and 2 jets pull-out shower.
 CR



511MM **MAXIMA**
 Miscelatore monocomando lavello bocca girevole doccia estraibile 2 getti.
 Single-lever sink mixer with swivel spout and 2 jets pull-out shower.
 CR



511HRC **HERM S**
 Miscelatore monocomando lavello con doccetta estraibile, 1 getto.
 Single-lever sink mixer with pull-out handshower, 1 jet.
 CR



511E2 **EPIC**
 Miscelatore monocomando lavello bocca girevole doccia estraibile 2 getti.
 Single-lever sink mixer with swivel spout and 2 jets pull-out shower.
 CR

BOCCA BASSA – LOW NECK



589E9 **EPIC**
 Miscelatore monocomando lavello con bocca girevole e leva clinica.
 Single-lever sink mixer with swivel spout and clinic lever.

CR



508MM **MAXIMA**
 Miscelatore monocomando lavello bocca girevole.
 Single-lever sink mixer with swivel spout.

CR



508E2 **EPIC**
 Miscelatore monocomando lavello bocca girevole.
 Single-lever sink mixer with swivel spout.

CR

MISCELATORI CON ATTACCO PER LAVASTOVIGLIE
 MIXERS WITH DISH-WASHING MACHINE CONNECTION



512E2 **EPIC**
 Miscelatore monocomando lavello con deviatore per lavastoviglie.
 Single-lever sink mixer with dish-washing machine diverter.

CR



512MM **MAXIMA**
 Miscelatore monocomando lavello con deviatore per lavastoviglie.
 Single-lever sink mixer with dish-washing machine diverter.

CR

- DESIGN
- TOUCH&ME
- ACQUA DEPURATA
DRINKING WATER
- BOCCA ALTA
HIGH NECK
- BOCCA BASSA
LOW NECK
- A PARETE
WALL MOUNT.
- DOPPI COMANDI
DOUBLE HANDLE





DESIGN

TOUCH-AME

ACQUA DEPURATA
DRINKING WATER

BOCCA ALTA
HIGH NECK

BOCCA BASSA
LOW NECK

A PARETE
WALL MOUNTG.

DOPPI COMANDI
DOUBLE HANDLE

A PARETE WALL MOUNTG.

LAVELLI A PARETE – WALL MTG. SINK MIXERS

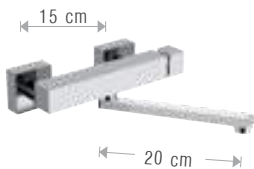

501CB **CUBIC**
Miscelatore monocomando lavello a parete bocca girevole.
Wall mtg. single-lever sink mixer with swivel spout.

CR

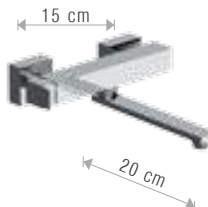

501PA **POLAR**
Miscelatore monocomando lavello a parete bocca girevole.
Wall mtg. single-lever sink mixer with swivel spout.

CR

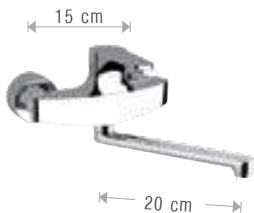

501SF **SURF**
Miscelatore monocomando lavello a parete canna girevole.
Wall mtg. single-lever sink mixer with swivel spout.

CR



501AT **ARTIC**
Miscelatore monocomando lavello a parete canna girevole.
Wall mtg. single-lever sink mixer with swivel spout.

CR



5010V **OVER**
Miscelatore monocomando lavello a parete canna girevole.
Wall mtg. single-lever sink mixer with swivel spout.

CR

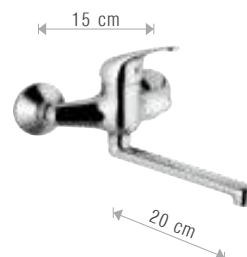

501E2 **EPIC**
Miscelatore monocomando lavello a parete canna girevole.
Wall mtg. single-lever sink mixer with swivel spout.

CR



505AVB AVENUE
 Miscelatore monocomando lavello, canna girevole alta e leva frontale.
 Single-lever wall mtg. sink mixer with swivel high spout and front lever.

CR



505SF SURF
 Miscelatore monocomando lavello, canna girevole alta e leva frontale.
 Single-lever wall mtg. sink mixer with swivel high spout and front lever.

CR



505E2 EPIC
 Miscelatore monocomando lavello, canna girevole alta e leva frontale.
 Single-lever wall mtg. sink mixer with swivel high spout and front lever.

CR



505ES ESSENZA
 Miscelatore monocomando lavello, canna girevole alta e leva frontale.
 Single-lever wall mtg. sink mixer with swivel high spout and front lever.

CR



5051D DOMINO
 Gruppo lavello a parete con bocca alta girevole.
 Wall mtg. sink mixer with high swivel spout.

CR



505MS MEISSA
 Gruppo lavello a parete con bocca alta girevole.
 Wall mtg. sink mixer with high swivel spout.

CR

DESIGN

TOUCH-AME

ACQUA DEPURATA
 DRINKING WATER

BOCCA ALTA
 HIGH NECK

BOCCA BASSA
 LOW NECK

A PARETE
 WALL MTDG.

DOPPI COMANDI
 DOUBLE HANDLE



5041D **DOMINO**
 Gruppo lavello a parete con bocca alta girevole.
 Wall mtg. sink mixer with swivel spout.

CR



504MS **MEISSA**
 Gruppo lavello a parete con bocca girevole.
 Wall mtg. sink mixer with swivel spout.

CR



502TR **TRADITION**
 Gruppo lavello a parete con bocca girevole.
 Wall mtg. sink mixer with swivel spout.

CR

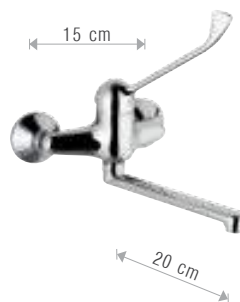

580E9 **EPIC**
 Miscelatore monocomando lavello a parete bocca girevole con leva clinica.
 Wall mtg. single-lever sink mixer with swivel spout and clinic lever.

CR



5021D **DOMINO**
 Gruppo lavello a parete con bocca girevole.
 Wall mtg. sink mixer with swivel spout.

CR



5141D **DOMINO**
 Gruppo lavello a parete con bocca girevole con attacco lavatrice.
 Wall mtg. sink mixer with swivel spout and washing machine outlet.

CR



502MS

MEISSA

Gruppo lavello a parete con bocca girevole.
Wall mounted sink mixer with swivel spout.

CR



514MS

MEISSA

Gruppo lavello a parete con bocca girevole e attacco lavatrice.
Wall mounted sink mixer with swivel spout and washing machine outlet.

CR



505MS

DESIGN

TOUCH&ME

ACQUA DEPURATA
DRINKING WATER

BOCCA ALTA
HIGH NECK

BOCCA BASSA
LOW NECK

A PARETE
WALL MOUNT.

DOPPI COMANDI
DOUBLE HANDLE





DOPPI COMANDI DOUBLE HANDLE

LAVELLI DOPPO COMANDO – DOUBLE HANDLE SINK MIXERS



3301D **DOMINO**

Monoforo lavello bocca girevole.
Single hole sink set with swivel spout.

CR



330MS **MEISSA**

Monoforo lavello bocca girevole.
Single hole sink set with swivel spout.

CR



336TR **TRADITION**

Monoforo lavello bocca girevole.
Single hole sink set with swivel spout.

CR



322TR **TRADITION**

Monoforo lavello bocca girevole.
Single hole sink set with swivel spout.

CR



337TR **TRADITION**

Monoforo lavello bocca girevole con
vitone ceramico.
Single hole sink set with swivel spout
with ceramic headvalve.

CR

CON OPZIONI DI FINITURA - WITH FINISHING OPTIONS



.06
Vecchio Ottone
Old Brass

337TR06

Vitone ceramico - Ceramic headvalve

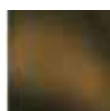

.SM
Ottone S.Marco
S.Marco Brass

337TRSM

Vitone ceramico - Ceramic headvalve



.OM
Vecchio Ottone Opaco
Matt Old Brass

337TROM

Vitone ceramico - Ceramic headvalve



.05
Vecchio Rame
Old Copper

337TR05

Vitone ceramico - Ceramic headvalve



.1D
Oil Bronze
Oil Bronze

337TR1D

Vitone ceramico - Ceramic headvalve



DOPPI COMANDI
DOUBLE HANDLE

A PARETE
WALL MOUNT.

BOCCA BASSA
LOW NECK

BOCCA ALTA
HIGH NECK

ACQUA DEPURATA
DRINKING WATER

TOUCH-AME

DESIGN

337TR

HI-TECH HI-TECH HI-TECH HI-TECH HI-TECH
HI-TECH HI-TECH HI-TECH HI-TECH HI-TECH
HI-TECH HI-TECH HI-TECH HI-TECH HI-TECH
HI-TECH HI-TECH HI-TECH HI-TECH HI-TECH
HI-TECH HI-TECH HI-TECH HI-TECH HI-TECH
HI-TECH HI-TECH HI-TECH HI-TECH HI-TECH
HI-TECH HI-TECH HI-TECH HI-TECH HI-TECH
HI-TECH HI-TECH HI-TECH HI-TECH HI-TECH
HI-TECH HI-TECH HI-TECH HI-TECH HI-TECH
HI-TECH HI-TECH HI-TECH HI-TECH HI-TECH
HI-TECH HI-TECH HI-TECH HI-TECH HI-TECH
HI-TECH HI-TECH HI-TECH HI-TECH HI-TECH
HI-TECH HI-TECH HI-TECH HI-TECH HI-TECH
HI-TECH HI-TECH HI-TECH HI-TECH HI-TECH
HI-TECH HI-TECH HI-TECH HI-TECH HI-TECH
HI-TECH HI-TECH HI-TECH HI-TECH HI-TECH
HI-TECH HI-TECH HI-TECH HI-TECH HI-TECH
HI-TECH HI-TECH HI-TECH HI-TECH HI-TECH
HI-TECH HI-TECH HI-TECH HI-TECH HI-TECH
HI-TECH HI-TECH HI-TECH HI-TECH HI-TECH
HI-TECH HI-TECH HI-TECH HI-TECH HI-TECH

HI-TECH HI-TECH HI-TECH HI-TECH HI-TECH
HI-TECH HI-TECH HI-TECH HI-TECH HI-TECH
HI-TECH HI-TECH HI-TECH HI-TECH HI-TECH
HI-TECH HI-TECH HI-TECH HI-TECH HI-TECH

HI-TECH HI-TECH HI-TECH HI-TECH HI-TECH
HI-TECH HI-TECH HI-TECH HI-TECH HI-TECH
HI-TECH HI-TECH HI-TECH HI-TECH HI-TECH
HI-TECH HI-TECH HI-TECH HI-TECH HI-TECH
HI-TECH HI-TECH HI-TECH HI-TECH HI-TECH
HI-TECH HI-TECH HI-TECH HI-TECH HI-TECH
HI-TECH HI-TECH HI-TECH HI-TECH HI-TECH
HI-TECH HI-TECH HI-TECH HI-TECH HI-TECH
HI-TECH HI-TECH HI-TECH HI-TECH HI-TECH
HI-TECH HI-TECH HI-TECH HI-TECH HI-TECH
HI-TECH HI-TECH HI-TECH HI-TECH HI-TECH
HI-TECH HI-TECH HI-TECH HI-TECH HI-TECH
HI-TECH HI-TECH HI-TECH HI-TECH HI-TECH
HI-TECH HI-TECH HI-TECH HI-TECH HI-TECH
HI-TECH HI-TECH HI-TECH HI-TECH HI-TECH
HI-TECH HI-TECH HI-TECH HI-TECH HI-TECH
HI-TECH HI-TECH HI-TECH HI-TECH HI-TECH
HI-TECH HI-TECH HI-TECH HI-TECH HI-TECH
HI-TECH HI-TECH HI-TECH HI-TECH HI-TECH
HI-TECH HI-TECH HI-TECH HI-TECH HI-TECH
HI-TECH HI-TECH HI-TECH HI-TECH HI-TECH
HI-TECH HI-TECH HI-TECH HI-TECH HI-TECH

HI-TECH

HI-TECH HI-TECH HI-TECH HI-TECH HI-TECH
HI-TECH HI-TECH HI-TECH HI-TECH HI-TECH
HI-TECH HI-TECH HI-TECH HI-TECH HI-TECH
HI-TECH HI-TECH HI-TECH HI-TECH HI-TECH





SENSOR

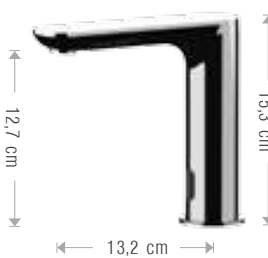

E1701

Rubinetto elettronico ad azionamento a sensore con regolazione acqua caldo/freddo tramite due rubinetti sottolavabo con filtro.
Electronic tap, with sensor control, for pre-mixed water equipped with two angle valves with filter.

CR



E1701CE

Come **E1701** alimentato a corrente elettrica.
As **E1701** powered by electricity.

CR

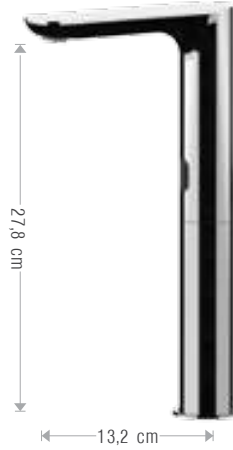

E2001L

Rubinetto alto elettronico ad azionamento a sensore con regolazione acqua caldo/freddo tramite due rubinetti sottolavabo con filtro.
Electronic high tap, with sensor control, for pre-mixed water equipped with two angle valves with filter.

CR



E2001LCE

Come **E2001L** alimentato a corrente elettrica.
As **E2001L** powered by electricity.

CR

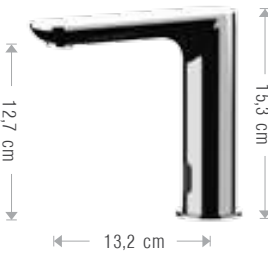

E1601

Rubinetto elettronico ad azionamento a sensore, mono-acqua dotato di rubinetto sottolavabo con filtro.
Electronic single water tap, with sensor control, equipped with angle valve with filter.

CR



E1601CE

Come **E1601** alimentato a corrente elettrica.
As **E1601** powered by electricity.

CR

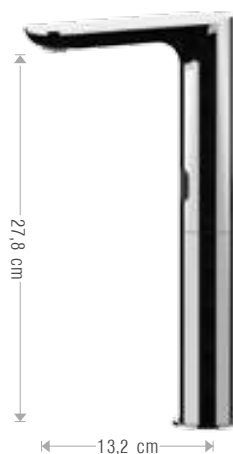

E1901L

Rubinetto alto elettronico ad azionamento a sensore, mono-acqua dotato di rubinetto sottolavabo con filtro.
Electronic high single water tap, with sensor control, equipped with angle valve with filter.

CR



E1901LCE

Come **E1901L** alimentato a corrente elettrica.
As **E1901L** powered by electricity.

CR





E1700

Rubinetto elettronico ad azionamento a sensore con regolazione acqua caldo/freddo tramite due rubinetti sottolavabo. Alimentato con batterie al litio.
Sensor control basin tap hot/cold water setting by two angle valves. Powered by lithium batteries.

CR



E1700CE

Come **E1700** alimentato a corrente elettrica.
As **E1700** powered by electricity.

CR

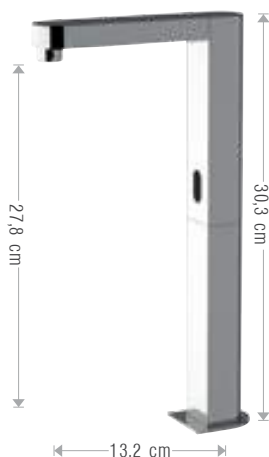

E2000L

Rubinetto alto elettronico ad azionamento a sensore con regolazione acqua caldo/freddo tramite due rubinetti sottolavabo. Alimentato con batterie al litio.
High sensor electronic control basin tap hot/cold water setting by two angle valves. Powered by lithium batteries.

CR



E2000LCE

Come **E2000L** alimentato a corrente elettrica.
As **E2000L** powered by electricity.

CR



E1600

Rubinetto elettronico mono acqua per lavabo, con azionamento a sensore, dotato di rubinetto sottolavabo con filtro. Alimentato con batterie al litio.
Electronic single water tap, with sensor control, equipped with angle valve with filter. Powered by lithium batteries.

CR



E1600CE

Come **E1600** alimentato a corrente elettrica.
As **E1600** powered by electricity.

CR

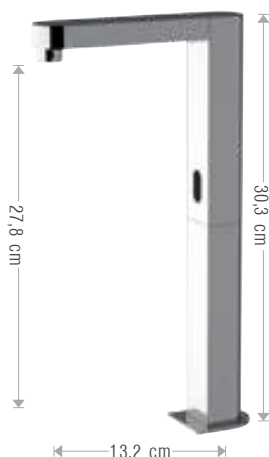

E1900L

Rubinetto elettronico mono acqua per lavabo, con azionamento a sensore, dotato di rubinetto sottolavabo con filtro. Alimentato con batterie al litio.
High sensor electronic single water tap, with sensor control, equipped with angle valve with filter. Powered by lithium batteries.

CR



E1900LCE

Come **E1900L** alimentato a corrente elettrica.
As **E1900L** powered by electricity.

CR

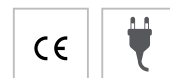

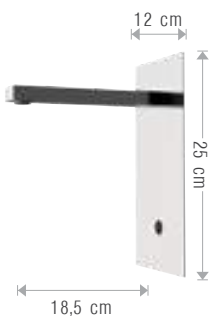

E3000

Rubinetto lavabo ad incasso a sensore, monoacqua. Alimentato con batterie al litio.
Built-in wash basin sensor mixer, single water. Powered by lythium batteries.

CR

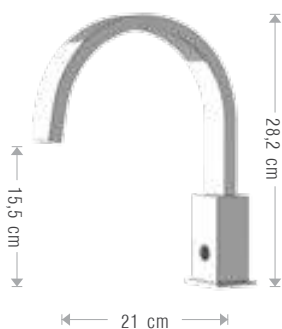

E3200

Rubinetto elettronico ad azionamento a sensore con regolazione acqua caldo/freddo tramite due rubinetti sottolavabo. Alimentato con batterie al litio.
Sensor control basin tap with hot/cold water setting by two angle valves. Powered by lythium batteries.

CR



S31L1

Rubinetto lavabo ad incasso a sensore, monoacqua, con dispositivo color (disponibile solo in versione D).
Built-in wash basin sensor mixer, single water, with color device (available only in D version).

CR





E3200

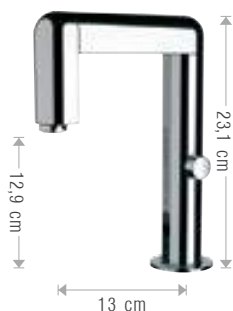

E1800

Rubinetto elettronico ad azionamento a sensore con regolazione acqua caldo/freddo. Alimentato con batterie al litio.
Sensor control basin tap with hot/cold water adjustment. Powered by lythium batteries.

CR



E1800CE

Come **E1800** alimentato a corrente elettrica.
As **E1800** powered by electricity.

CR

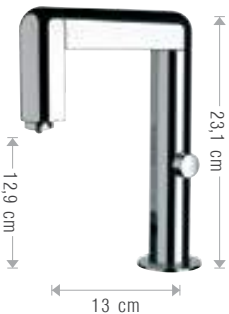

E18L1

Rubinetto elettronico con regolazione acqua caldo/freddo ad azionamento a sensore con cromoterapia dotato di microturbina e tecnologia LED. La luce cambia in funzione della temperatura dell'acqua, dal freddo blu al caldo rosso, passando per il verde con acqua miscelata. Alimentato con batterie al litio.

Sensor control basin tap with hot/cold water adjustment, colorthery with microturbine and LED technology. The light changes with the water temperature, from cold blue to hot red, passing through green mixed water. Powered by lythium batteries.

CR



E18L1CE

Come **E18L1** alimentato a corrente elettrica.
As **E18L1** powered by electricity.

CR

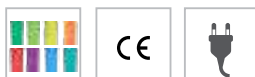



SENSOR

TEMPOR TOUCH

TEMPOR

E18L1

SENSOR



E14
 Miscelatore elettronico ad azionamento a sensore con regolazione acqua caldo/freddo.
 Sensor control mixer with hot/cold water adjustment.

CR



E14B
 Miscelatore elettronico ad azionamento a sensore con regolazione acqua caldo/freddo con basetta.
 Sensor control mixer with hot/cold water adjustment with base-plate.

CR



E14C
 Rubinetto elettronico monoacqua ad azionamento a sensore.
 Single water sensor control basin tap.

CR



E14D
 Rubinetto elettronico monoacqua ad azionamento a sensore con basetta.
 Single water sensor control basin tap with base-plate.

CR



ARTICOLI COMPLEMENTARI — COMPLEMENTARY ITEMS



E7100
 Dispenser a sensore per sapone liquido e liquido disinfettante.
 Sensor dispenser for liquid soap and liquid disinfectant.

CR





E14B



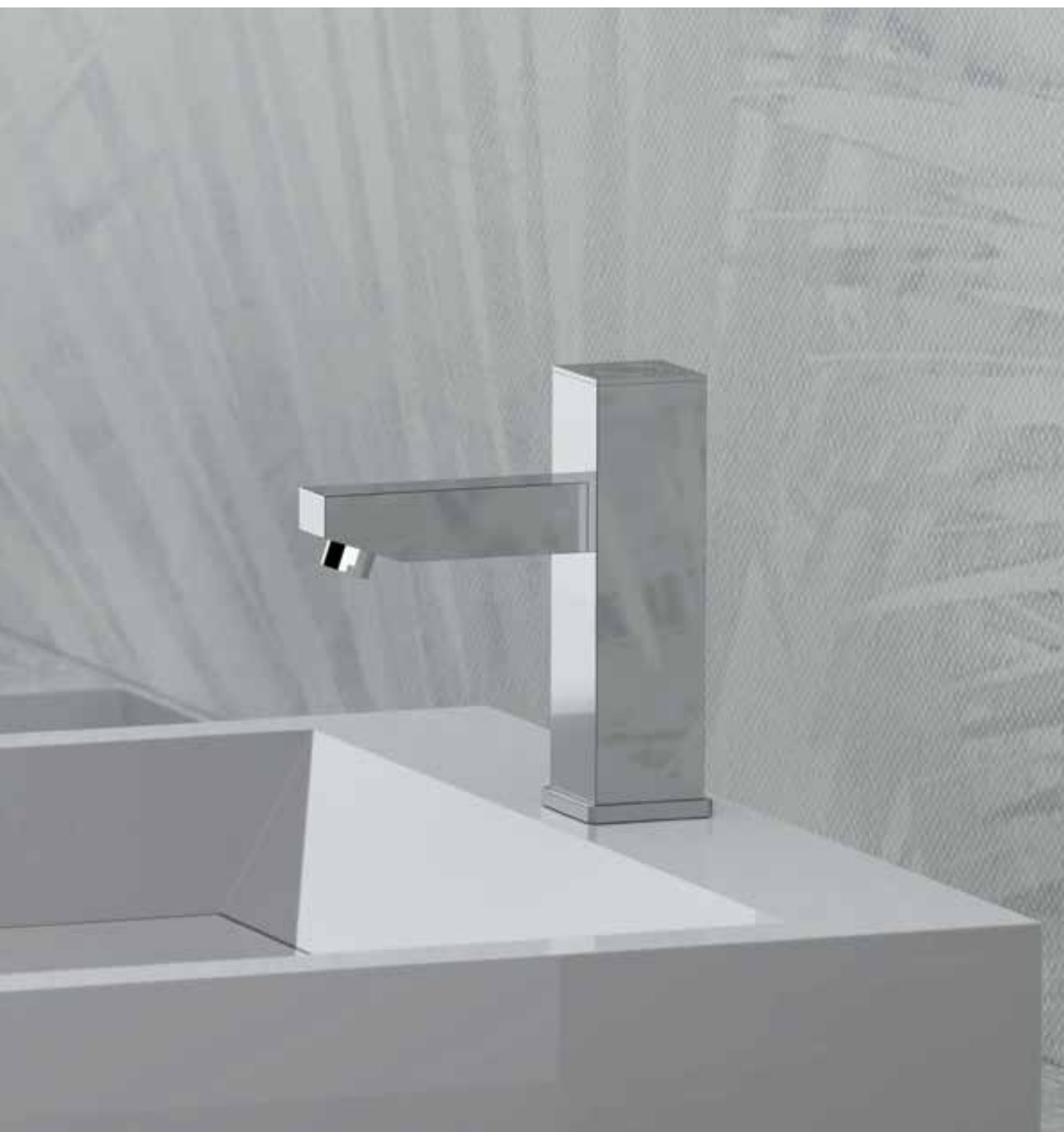

TEMPOR TOUCH

La temporizzazione elettronica dei modelli TEMPOR TOUCH si avvale della tecnologia di attivazione PIEZO.

L'erogazione dell'acqua si attiva tramite la pressione di un pulsante piezoelettrico e si interrompe automaticamente dopo un periodo o su richiesta con una successiva pressione del tasto.

La tecnologia impiegata da questo prodotto si contraddistingue dalla capacità di elevare il livello di precisione e sicurezza, e di assicurare le prestazioni desiderate anche su installazioni multiple e/o in linea.

Durata dell'erogazione con impostazione di fabbrica: 10 secondi circa (erogazione istantanea a fronte della pressione del tasto).

The electronic timing of TEMPOR TOUCH models uses PIEZO activation technology.

The water supply is activated by pressing a piezoelectric button and automatically stops after a while or upon request with a further subsequent pressing.

The technology used by this products is characterized by the ability to raise the level of precision and safety, and ensure the desired performance even on multiple installations and/or in line.

Water supply with factory setting: about 10 seconds lasting (instant delivery upon pressing the button).

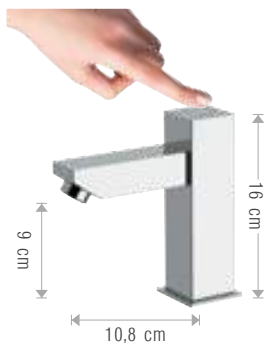

Q10TP

Rubinetto a temporizzazione elettronica con attivazione tramite pulsante ad azionamento piezoelettrico alimentato a batteria, minimale quadrato, in ottone cromato, tempo d'apertura circa 10 secondi.

Electronic timing pillar tap with piezoelectric activation button, powered by batteries, minimal squared shape, completely in c.p. brass, opening time about 10 seconds.

CR



T10TP

Rubinetto a temporizzazione elettronica con attivazione tramite pulsante ad azionamento piezoelettrico alimentato a batteria, minimale tondo, in ottone cromato, tempo d'apertura circa 10 secondi.

Electronic timing pillar tap with piezoelectric activation button, powered by batteries, minimal round shape, completely in c.p. brass, opening time about 10 seconds.

CR





SENSOR

TEMPOR TOUCH

TEMPOR

T10TP





TEMPOR

LAVABI - WASHBASIN MIXERS

**393TP**

Rubinetto miscelatore temporizzato, tempo di apertura 6-8 secondi.
Temporized mixer pillar tap, opening time 6-8 seconds.

CR

**35BTP**

Rubinetto temporizzato, tempo di apertura 6-8 secondi.
Temporized pillar tap, opening time 6-8 seconds.

CR

**35ATP**

Rubinetto temporizzato, tempo di apertura 6-8 secondi.
Temporized pillar tap, opening time 6-8 seconds.

CR

**35DTP**

Rubinetto temporizzato a collo cigno, 1/2", in ottone cromato, tempo d'apertura 6-8 secondi.
Temporized (swan-neck) pillar tap, 1/2", completely in c.p. brass, opening time 6-8 seconds.

CR





35BTP



35KTP

Rubinetto miscelatore temporizzato a collo cigno con maniglia per la selezione dell'acqua calda/fredda, serie minimal, 1/2", in ottone, tempo di apertura 6-8 secondi.
 Temporized (timer) mixer pillar tap with hot/cold water selection handle, serie minimal, 1/2", in brass, opening time 6-8 seconds.

CR



35QTP

Miscelatore a muro temporizzato per lavello con canna girevole.
 Wall mounted temporized sink mixer, with movable spout.

CR



35FTP

Rubinetto frontale temporizzato, con canna "S", 1/2", in ottone cromato, tempo d'apertura 6-8 secondi.
 Temporized (timer) frontal mounted 1/2" tap, with "S" spout, completely in c.p. brass, opening time 6-8 seconds.

CR

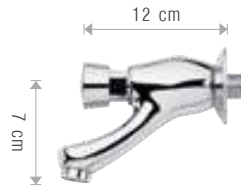

35ETP

Rubinetto frontale temporizzato, 1/2", in ottone cromato, tempo d'apertura 6-8 secondi.
 Temporized (timer) frontal mounted 1/2" tap, completely in c.p. brass, opening time 6-8 seconds.

CR

TOILET



24ATP

Set composto da: doccia a pulsante, flessibile conico 120 cm, rubinetto temporizzato 1/2", tempo d'apertura 6-8 secondi.
 Set composed by: shut-off handshower, conical flexible 120 cm, temporized pillar tap 1/2", opening time 6-8 seconds.

CR



35ITP

Rubinetto temporizzato a pulsante per orinatoio, 1/2", in ottone, completo di rosoni, di due tubetti Ø mm 14 e guarnizione. Tempo d'apertura 6-8 secondi.
 Temporized (timer) urinal button flusher, 1/2", in brass, in a set with flanges, two copper tubes Ø mm 14 and a washer. Opening time 6-8 seconds.

CR



24AISTP

Set composto da: idroscopino a pulsante, flessibile conico 120 cm, rubinetto temporizzato 1/2", tempo d'apertura 6-8 secondi.
 Set composed by: hydro brush handshower, flexible 120 cm, temporized pillar tap 1/2", opening time 6-8 seconds.

CR



35JTP

Rubinetto temporizzato a pulsante per orinatoio, serie SQ, 1/2", in ottone, completo di rosoni, di due tubetti Ø mm 14 e guarnizione. Tempo d'apertura 6-8 secondi.
 Temporized (timer) urinal button flusher serie SQ, 1/2", in brass, in a set with flanges, two copper tubes Ø mm 14 and a washer. Opening time 6-8 seconds.

CR



Flussometro temporizzato a pulsante esterno per WC, tempo d'apertura 6-8 secondi, misure 3/4", 1".
Temporized (timer) wall mounted tap with external button, for WC, opening time 6-8 seconds: 3/4", 1".

601TP1	1"
601TP34	3/4"



35HTP

Flussometro temporizzato a incasso, a pulsante, per wc, 3/4, 1", tempo d'apertura 6-8 secondi.
Temporized (timer) built-in tap, for wc, 3/4, 1", opening time 6-8 seconds.

CR

DOCCIA - SHOWER MIXERS



35GTP

Rubinetto per doccia incasso temporizzato, 1/2", tempo d'apertura 18-20 secondi.
Temporized (timer) wall mounted tap, 1/2", opening time 18-20 seconds.

CR



35PTP

Rubinetto temporizzato a pulsante per doccia esterno, 1/2"x1/2", in ottone, tempo d'apertura 18-20 secondi.
Temporized (timer) tap for shower, 1/2"x1/2", external, all in brass, opening time 18-20 seconds.

CR



35NTP

Miscelatore doccia temporizzato da incasso.
Built-in temporized shower mixer.

CR



35MTP

Miscelatore doccia temporizzato da incasso.
Built-in temporized shower mixer.

CR





COMPONENTI COMPONENTS



701

Sifone a S in ottone cromato, canotto 25 cm 1" 1/4.
C.p. brass S trap, cm 25 outlet tube, 1" 1/4.

CR



700

Sifone a bottiglia in ottone cromato, canotto 25 cm 1" 1/4.
C.p. brass bottle trap, cm 25 outlet tube, 1" 1/4.

CR



70A

Sifone a "S" in zama, canotto cm 25, 1" 1/4.
"S" trap in zamac, 25 cm outlet tube, 1" 1/4.

CR



702

Sifone a U in ottone cromato, canotto 25 cm 1" 1/4.
C.p. brass U trap, cm 25 outlet tube, 1" 1/4.

CR

CON OPZIONI DI FINITURA – WITH FINISHING OPTIONS



700NU

Sifone "minimal" 1" 1/4 in ottone cromato per lavabo, canotto cm 30, bottiglia h 13 cm.
"Minimal" trap 1" 1/4 chromed for wash-basin, outlet tube 30 cm bottle h 13 cm.

CR

FIN (.14 .37 .08)



700QD

Sifone quadrato 1" 1/4 in ottone cromato, ispezionabile.
Squared trap 1" 1/4, chromed, inspectable.

CR

FIN (.14 .37 .08)



703NU

Sifone "minimal" 1" 1/4 in ottone cromato per bidet, canotto cm 30, bottiglia h 9 cm.
"Minimal" trap 1" 1/4 chromed, for bidet, outlet tube 30 cm bottle h 9 cm.

CR

FIN (.14 .37 .08)



440CC

Scarico automatico da 1" 1/4 con sistema click-clack e troppo pieno.
Automatic pop-up waste 1" 1/4 with click-clack system and overflow.

CR

FIN (.14 .37 .08)



441CC

Scarico automatico da 1" 1/4 con sistema click-clack, senza troppo pieno.
Automatic pop-up waste 1" 1/4 with click-clack system, without overflow.

CR

FIN (.14 .37 .08)



440QD

Scarico automatico quadrato da 1" 1/4 con sistema click-clack e troppo pieno.
Squared automatic pop-up waste 1" 1/4 with click-clack system and overflow.

CR

FIN (.14 .37 .08)



441QD

Scarico automatico quadrato da 1" 1/4 con sistema click-clack, senza troppo pieno.
Squared automatic pop-up waste 1" 1/4 with click-clack system, without overflow.

CR

FIN (.14 .37 .08)

**441SB**

Scarico automatico da 1" 1/4 con sistema click-clack, senza troppo pieno. Senza bicchiere estetico.
Automatic pop-up waste 1" 1/4 with click-clack system and without overflow. Without aesthetic cup.

CR

**44ASB**

Scarico automatico da 1" 1/4 con sistema click-clack, con troppo pieno. Automatic pop-up waste 1" 1/4 with click-clack system, with overflow.

CR

**852**

Rubinetto sottolavabo con filtro e snodo 1/2x10.
Angle valve with filter balljoint, 1/2x10.

CR

**853**

Rubinetto sottolavabo con filtro e dado 1/2x10.
Angle valve with filter and nut 1/2x10.

CR

**85A**

Rubinetto sottolavabo con filtro, 1/2x3/8, con rosetta in ottone cromato.
C.P. brass angle valve with filter and flange, 1/2x3/8.

CR

**85B**

Rubinetto sottolavabo con filtro, 1/2x1/2, con rosetta in ottone cromato.
C.P. brass angle valve with filter and flange, 1/2x1/2.

CR

**850HR**

Rubinetto sottolavabo, con vitone ceramico, con maniglia a leva, 1/2x10.
C.P. brass angle valve, with ceramic headvalve, with lever handle, 1/2x10.

CR

**850QD**

Rubinetto sottolavabo, con vitone ceramico, con maniglia a leva, 1/2x10.
C.P. brass angle valve, with ceramic headvalve, with lever handle, 1/2x10.

CR

**85AHR**

Rubinetto sottolavabo, con vitone ceramico, con maniglia a leva 1/2x3/8.
C.P. brass angle valve, with ceramic headvalve, with lever handle, 1/2x3/8.

CR

**85AQD**

Rubinetto sottolavabo, con vitone ceramico, con maniglia a leva, 1/2x3/8.
C.P. brass angle valve, with ceramic headvalve, with lever handle, 1/2x3/8.

CR

**85BHR**

Rubinetto sottolavabo, con vitone ceramico, con maniglia a leva, 1/2x1/2.
C.P. brass angle valve, with ceramic headvalve, with lever handle, 1/2x1/2.

CR

**85BQD**

Rubinetto sottolavabo, con vitone ceramico, con maniglia a leva, 1/2x1/2.
C.P. brass angle valve, with ceramic headvalve, with lever handle, 1/2x1/2.

CR

**800**

Rubinetto arresto a cappuccio.
Isolating valve with chrome tap.

CR

RICAMBI – SPARE PARTS

**W992086300**

Cartuccia monocomando Ø 25 mm di tipo aperto.
Single-lever mixer Ø 25 mm cartridge open type.

CR

SERIE - SERIES**IDONEO PER - SUITABLE FOR:**

POLAR	380 - 382 - 393 - 39APA - 397 - 398 - 399 - 212 - 230 - 480 - 493 - 571
AVENUE / 5 TH AVENUE	380 - 393 - 398 - 480 - 493
Esclusi lavelli ed altri prodotti Excluded Kitchen mixers and other products	

**W992124300**

Cartuccia monocomando Ø 25 mm di tipo chiuso.
Single-lever mixer Ø 25 mm cartridge closed type.

CR

SERIE - SERIES**IDONEO PER - SUITABLE FOR:**

AVENUE / 5 TH AVENUE	565 - 565AVP - 565AVL - 565AVPL
ULTRAMINIMAL	380 - 393 - 480 - 493 - 398 - 565 - 565UMP
POLAR	14PA - 252 - 259 - 501 - 565PAP - 565PA - 565PAPL - 565PAL
SHUT-OFF	14ADD - 14ACB - 14APA - 14AUM
CUBO	501CB
Esclusi lavelli ed altri prodotti Excluded Kitchen mixers and other products	

**W992108900**

Cartuccia monocomando Ø 35 mm con oring alto.
Single-lever mixer Ø 35 mm cartridge with upper oring.

CR

SERIE - SERIES**IDONEO PER - SUITABLE FOR:**

AVENUE / 5 TH AVENUE	212 - 230
ARMONIA	380 - 393 - 398 - 480 - 493 - 212 - 230 - 252 - 594 - 595 - 596 - 597
NEXT	212 - 230 - 21B
ARTIC	212 - 230 - 393 - 39A - 398 - 493
ESSENZA	393 - 493
Esclusi lavelli ed altri prodotti Excluded Kitchen mixers and other products	

**W992072600**

Cartuccia monocomando Ø 35 mm con distributore
Single-lever mixer Ø 35 mm cartridge with distributor.

CR

SERIE - SERIES**IDONEO PER - SUITABLE FOR:**

AVENUE / 5 TH AVENUE	252AV - 254AV - 505
RIVER	252
ARTIC	252 - 292 - 501 - 505 - 510 - 571 - 571ATB - 571ATBC - 570
SURF	212 - 230 - 25A - 231 - 252 - 254 - 393 - 380 - 39A - 398 - 493 - 480 - 570 - 57A - 501 - 571SFB - 292 - 505 - 571SFBC
MARTE	212 - 230 - 252
ESSENZA	398 - 230 - 212 - 570 - 505
SHUT-OFF	25ASF
PLUTO	571PN - 511PN
Esclusi lavelli ed altri prodotti Excluded Kitchen mixers and other products	

**W992054800**

Cartuccia monocomando Ø 40 mm con distributore.
Single-lever mixer Ø 40 mm cartridge with distributor.

CR

SERIE - SERIES**IDONEO PER - SUITABLE FOR:**

EPIC	230 - 231 - 252 - 254 - 393 - 39XE2 - 493 - 489 - 505 - 506 - 570 - 57A - 57AE2 - 57AE9 - 501 - 580 - 571
MAXIMA	393 - 382 - 493 - 230 - 212 - 570
Esclusi lavelli ed altri prodotti Excluded Kitchen mixers and other products	

**W992054900**

Cartuccia monocomando Ø 40 mm con fondo piatto.
Single-lever mixer Ø 40 mm flat cartridge.

CR

SERIE - SERIES**IDONEO PER - SUITABLE FOR:**

EPIC	173 - 179 - 237 - 239 - 306 - 402 - 508 - 510 - 511 - 512 - 589 - D72E2
MAXIMA	173 - 179 - 237 - 508 - 511 - 512
Esclusi lavelli ed altri prodotti Excluded Kitchen mixers and other products	

**W992060000**

Cartuccia monocomando Ø 35 mm con fondo piatto.
Single-lever mixer Ø 35 mm flat cartridge.

CR

SERIE - SERIES**IDONEO PER - SUITABLE FOR:**

AVENUE / 5 TH AVENUE	185AVW - 173 - 179 - 173AVP2 - 173AVP3 - 173AVP4 - 173AVP5 - 173AVPP4 - 173AVPP5 - 305AV - 506AVC - 506584 - 585 - 57D - 519 - 518AV1
ARMONIA	179 - 173 - 173ARP2 - 173ARP3 - 185ARW - 305 - 565 - 591 - 506
ULTRAMINIMAL	179 - 173 - 173UMP2 - 173UMP3 - 173UMP4 - 173UMP5 - 176UMPP2 - 185UMW - 21AUM - 212 - 230 - 252 - 305 - 385 - D74UMTFDW
POLAR	173 - 179 - 173PAP2 - 173PAP3 - 173PAP4 - 173PAPP4 - 173PAP5 - 173PAPP5 - 175 - 21A - 236 - 237 - 239 - 39G - 305 - 385 - 570
NEXT	173 - 179 - 173NXP2 - 173NXP3 - 185 - 21A - 21B - 237 - 252 - 259 - 305 - 393 - 39ANX - 398NX - 385 - 493 - 565 - 565NXP - 501 - 57D - 584 - 585
RIVER	179 - 173 - 173RIP2 - 173RIP3 - 239 - 493
ARTIC	179 - 173 - 173ATP2 - 173ATP3 - 173ATP4 - 173ATP5 - 173ATPP4 - 173ATPP5 - 21A - 237 - 382 - 385 - 506 - 506ATC - 57D - 510 - 565 - 506ATT - 507ATT - L84 - L84DJ
SURF	179 - 173 - 173SFP2 - 173SFP3 - 173SFP4 - 173SFP5 - 174 - 182 - 185 - 21A - 236 - 237 - 239 - 305 - 385 - 386SF - 506 - 510 - 506SFT - 507SFT - 565 - 565SFL - 516 - 518 - 519 - 560 - 57D - 581 - 584 - 585
MARTE	173 - 179 - 173MAP2 - 173MAP3 - 173MAP4 - 173MAP5 - 237 - 393 - 397 - 493 - 565 - 570
HERM S	175 - 179 - 173 - 173HRP2 - 173HRP3 - 174 - 182 - 185 - 212 - 21A - 230 - 237 - 252 - 305 - 402 - 405 - 385 - 393 - 397 - 493 - 565 - 57D - 506 - 507 - 508 - 511 - 577
ESSENZA	173 - 179 - 173ESP2 - 173ESP3 - 50A - 565
DEVIATORI - DIVERTERS	173N1 - 173N2 - 173N3 - 173N4 - 173N5 - 173P1 - 173P2 - 173P3 - 173P4 - 173P5
SHUT-OFF	185PA - 185NXW
NOIR	236
PLUTO	571NU
CUBO	239CB
<p>Esclusi lavelli ed altri prodotti Excluded Kitchen mixers and other products</p>	

**W992107200**

Cartuccia, deviatore a 2 uscite.
Cartridge, 2 exits diverter.

CR

SERIE - SERIES**IDONEO PER - SUITABLE FOR:**

AVENUE / 5 TH AVENUE	173AVP2 - 126AVP2
ARMONIA	173ARP2
ULTRAMINIMAL	173UMP2 - 176UMPP2
POLAR	173PAP2
NEXT	173NXP2
RIVER	173RIP2
ARTIC	173ATP2
SURF	173SFP2
MARTE	173MAP2
HERM S	173HRP2
ESSENZA	173ESP2
DEVIATORI - DIVERTERS	173N2
TERMOSTATICI - THERMOSTATICS	126T1 - 126Q1
Esclusi lavelli ed altri prodotti Excluded Kitchen mixers and other products	

**W992090100**

Cartuccia, deviatore a 3 uscite.
Cartridge, 3 exits diverter.

CR

SERIE - SERIES**IDONEO PER - SUITABLE FOR:**

AVENUE / 5 TH AVENUE	173AVP3 - 126AVP3
ARMONIA	173ARP3
ULTRAMINIMAL	173UMP3
POLAR	173PAP3
NEXT	173NXP3
RIVER	173RIP3
ARTIC	173ATP3
SURF	173SFP3
MARTE	173MAP3
HERM S	173HRP3
ESSENZA	173ESP3
DEVIATORI - DIVERTERS	123PA - 123NO - 173N3
TERMOSTATICI - THERMOSTATICS	126T2 - 126Q2
Esclusi lavelli ed altri prodotti Excluded Kitchen mixers and other products	

**W992082000**

Cartuccia, deviatore a 5 uscite.
Cartridge, 5 exits diverter.

CR

SERIE - SERIES**IDONEO PER - SUITABLE FOR:**

AVENUE / 5 TH AVENUE	173AVP4 - 173AVP5 - 173AVPP4 - 173AVPP5 - 126AVP4 - 126AVP5
ULTRAMINIMAL	173UMP4 - 173UMP5
POLAR	173PAP4 - 173PAP5 - 173PAPP4 - 173PAPP5
RIVER	173RIP4 - 173RIP5
ARTIC	173ATP4 - 173ATP5 - 173ATPP4 - 173ATPP5
SURF	173SFP4 - 173SFP5
MARTE	173MAP4 - 173MAP5
DEVIA TORI - DIVERTERS	121PA - 121NO - 173N4 - 173N5 - 173P4 - 173P5
TERMOSTATICI - THERMOSTATICS	126T4 - 126Q4

Esclusi lavelli ed altri prodotti
Excluded Kitchen mixers and other products

**W992090000**

Valvola termostatica coassiale.
Coaxial thermostatic valve.

CR

SERIE - SERIES**IDONEO PER - SUITABLE FOR:**

AVENUE / 5 TH AVENUE	126AV5P2 - 126AV5P3 - 126AV5P4 - 126AV5P5
	125T1 - 125Q1 - 126T1 - 126Q1 - 126T2 - 126Q2 - 126T4 - 126Q4

Esclusi lavelli ed altri prodotti
Excluded Kitchen mixers and other products

**W992135800**

Valvola termostatica Ø 34 mm.
Thermostatic valve Ø 34 mm.

CR

SERIE - SERIES**IDONEO PER - SUITABLE FOR:**

TERMOSTATICI VASCA BATHTUB THERMOSTATIC	270T3 - 273T3 - 272T3 - 27AT3 - 274TQA - 274TQB - 274T3 - 2702T - 270 - 271 - 272
--	---

Esclusi lavelli ed altri prodotti
Excluded Kitchen mixers and other products



W992123600

Cartuccia deviatore 2 vie con chiusura.
2-outlets diverter cartridge with shut-off.

CR

SERIE - SERIES

IDONEO PER - SUITABLE FOR:

EQUILIBRE	273T3 - 272T3 - 27AT3 - 274TQA 274TQB - 274T3



W992129800

Cartuccia d.35 fondo piatto risparmio acqua.
Ø35 water saving cartridge, flat bottom.

CR

SERIE - SERIES

IDONEO PER - SUITABLE FOR:

RIVER	212 - 21A - 230 - 393 - 397 - 565 385



W992130100

Cartuccia d.35 c/distrib ECO/C3.
Ø35 ECO/C3 cartridge, with distributor.

CR

SERIE - SERIES

IDONEO PER - SUITABLE FOR:

SURF ECO	393 - 380 - 39A - 398 - 493 - 480 231 - 570 - 501



W992152300

Cartuccia d.35 fondo piatto eco/C3
Ø35 ECO/C3 cartridge, flat bottom.

CR

SERIE - SERIES

IDONEO PER - SUITABLE FOR:

SURF ECO	185 - 385 - 506 - 510 - 565



W992039600

Vitone a dischi ceramici G1/2" Z20 180°.
In blister 2 pezzi.
G1/2" Z20 180° ceramic discs head-valve.
2 pieces in blister.

CR

SERIE - SERIES

IDONEO PER - SUITABLE FOR:

TERMOSTATICI - THERMOSTATICS	270T3 - 270T2 - 272



W992090300

Vitone ceramico Z 20 90°. Per apertura/
chiusura flusso.
Ceramic Headvalve Z 20 90°. for opening/
closing of the flow.

CR

SERIE - SERIES

IDONEO PER - SUITABLE FOR:

TERMOSTATICI - THERMOSTATICS	270 - 271 - 272



W992097900

Vitone ceramico 1/2" Z24.
Ceramic Headvalve 1/2" Z24.

CR

SERIE - SERIES

IDONEO PER - SUITABLE FOR:

MEISSA	Tutta la serie - The whole series

PROLUNGHE PER MISCELATORE DOCCIA INCASSO EXTENSIONS FOR BUILT-IN SHOWER MIXER



W002088100

Deviatore con pomolo tondo per incasso doccia.
Diverter with round knob for built-in shower mixer.

CR

SERIE - SERIES

IDONEO PER - SUITABLE FOR:

AVENUE / 5 TH AVENUE	173AV - 173AV5
ARMONIA	173AR
POLAR	173PA
NEXT	173NX
RIVER	173RI
ARTIC	173AT
SURF	173SF - 174SF
MARTE	173MA
HERM S	173HR - 174HR
EPIC	173E2
MAXIMA	173MM
DEVIATORI - DIVERTERS	173N1 - 173P1



W002088500

Prolunga per incasso doccia con deviatore con pomolo tondo per cartuccia Ø 35 mm con fondo piatto.
Extension for built-in shower mixer body with diverter with round knob with Ø 35 mm flat cartridge.

IDONEO PER - SUITABLE FOR:

Tutte le serie, escluse: EPIC, MAXIMA ed OVER
All the series, excluded: EPIC, MAXIMA and OVER

CR



W002088400

Prolunga per incasso doccia per cartuccia Ø 35 mm con fondo piatto.
Extension for built-in shower mixer body for Ø 35 mm flat cartridge.

IDONEO PER - SUITABLE FOR:

Tutte le serie, escluse: EPIC, MAXIMA ed OVER
All the series, excluded: EPIC, MAXIMA and OVER

CR



W002088700

Prolunga per incasso doccia con deviatore con pomolo tondo per cartuccia Ø 40 mm con fondo piatto.
Extension for built-in shower mixer body with diverter with round knob with Ø 40 mm flat cartridge.

IDONEO PER - SUITABLE FOR:

Art. 173 EPIC - MAXIMA - OVER
Escluse altre serie.
Art. 173 EPIC - MAXIMA - OVER
Excluded all other series.

CR



W002088600

Prolunga per incasso doccia per cartuccia Ø 40 mm con fondo piatto.
Extension for built-in shower mixer body for Ø 40 mm flat cartridge.

IDONEO PER - SUITABLE FOR:

Art. 179 EPIC - MAXIMA - OVER
Escluse altre serie.
Art. 179 EPIC - MAXIMA - OVER
Excluded all other series.

CR

**W002140500**

Prolunga per incasso doccia con deviatore meccanico a 3 vie con cartuccia Ø 35 mm con fondo piatto.
Extension for built-in shower mixer body with 3-ways diverter for flat bottom type Ø 35 mm cartridge.

IDONEO PER - SUITABLE FOR:

Art. 173 P3
Art. 173 P3

CR

**W002133000**

Prolunga per incasso doccia con deviatore meccanico a 2 vie con cartuccia Ø 35 mm con fondo piatto.
Extension for built-in shower mixer body with 2-ways diverter for flat bottom type Ø 35 mm cartridge.

IDONEO PER - SUITABLE FOR:

Art. 173 P2
Art. 173 P2

CR

PROLUNGHE PER MISCELATORE LAVABO INCASSO EXTENSION FOR BUILT-IN BASIN MIXER

**W002142100**

Prolunga per lavabo incasso.
Anche in versione "Box Incasso"
Extension for built-in basin mixer.
Also available in "Built-in Box" version.

IDONEO PER - SUITABLE FOR:

565AV - 565AVP - 565UM - 565UMP

CR

**W002149200**

Prolunga per lavabo incasso.
Anche in versione "Box Incasso"
Extension for built-in basin mixer.
Also available in "Built-in Box" version.

IDONEO PER - SUITABLE FOR:

565PA - 565PAP

CR

**W002149300**

Prolunga per lavabo incasso.
Anche in versione "Box Incasso"
Extension for built-in basin mixer.
Also available in "Built-in Box" version.

IDONEO PER - SUITABLE FOR:

565ES - 565NO

CR

**W002149400**

Prolunga per lavabo incasso.
Anche in versione "Box Incasso"
Extension for built-in basin mixer.
Also available in "Built-in Box" version.

IDONEO PER - SUITABLE FOR:

565AT - 565SF - 565MA - 565NX

CR

**W002149500**

Prolunga per lavabo incasso.
Anche in versione "Box Incasso"
Extension for built-in basin mixer.
Also available in "Built-in Box" version.

IDONEO PER - SUITABLE FOR:

565AR - 565NXP

CR

PROLUNGHE PER COLONNE DOCCIA EXTENSION FOR SHOWER COLUMNS



W002097800

Prolunga di 20 cm per colonna doccia da Ø 22 mm.
20 cm extension for Ø 22 mm shower column.

CR



W002150000

Prolunga di 20 cm per colonna doccia da Ø 25 mm.
20 cm extension for Ø 25 mm shower column.

CR

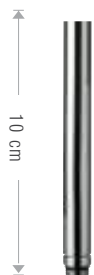

W002150100

Prolunga di 10 cm per colonna doccia da Ø 30 mm.
10 cm extension for Ø 30 mm shower column.

CR



W002150200

Prolunga di 20 cm per colonna doccia da Ø 30 mm.
20 cm extension for Ø 30 mm shower column.

CR



W002098800

Prolunga di 10 cm per colonna doccia quadrata.
10 cm extension for square shower column.

CR



W002126100

Prolunga di 20 cm per colonna doccia quadrata.
20 cm extension for square shower column.

CR

AERATORI — AERATORS

LIMITATORE DI PORTATA - FLOW LIMITER

**W002152200**

Aeratore lavabo e bidet per risparmio idrico con limitatore di portata da **6 litri al minuto**.
Aerator for wash basin and bidet mixers water saving, with reduction of consumption and flow at **6 litres by minute**

CR



6 L/min

**309RL8**

Raccordo doccia a risparmio idrico con limitatore di portata da **8 litri al minuto**.
C.p. brass connection, water saving program with flow reduction at **8 liters by minute**.

CR



8 L/min

**W002035400**

Aeratore femmina M22x1 (5 pezzi).
Female aerator M22x1 (5 units).

CR

**W002035500**

Aeratore maschio M24x1 (5 pezzi).
Male aerator M24x1 (5 units).

CR

**W002091800**

Aeratore a **risparmio idrico** M24x1 (5 pezzi).
Water-saving aerator M24x1 (5 units).

CR

**W002093200**

Aeratore maschio con **sistema anti-calcare** M24x1 (5 pezzi).
Anti-limestone system male aerator M24x1 (5 units).

CR

**W002035600**

Aeratore maschio M28x1 (5 pezzi).
Male aerator M28x1 (5 units).

CR

**W002093300**

Aeratore femmina M16x1 (2 pezzi).
Female aerator M16x1 (2 units).

CR

**W002062700**

Aeratore maschio M18x1 (2 pezzi).
Male aerator M18x1 (2 units).

CR

**W002140100**

Aeratore M18,5x1 con chiavetta.
Aerator M18,5x1 with cleaning key.

CR

**W002086100**

Aeratore flat M24x1 con chiavetta (3 pezzi).
Flat aerator M18,5x1 with cleaning key (3 units).

CR

**W002150800**

Aeratore flat M16,5x1 con chiavetta.
Flat aerator M16,5x1 with cleaning key.

CR

ESPOSITORI — DISPLAYERS

ESPOSITORI DA PAVIMENTO — FLOOR DISPLAYERS

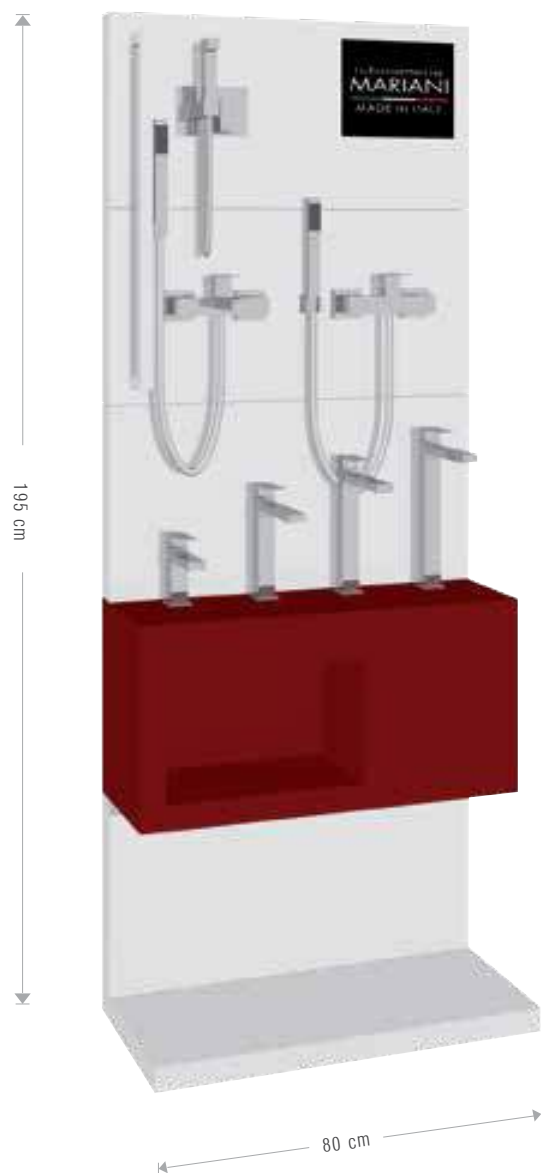

ESP01

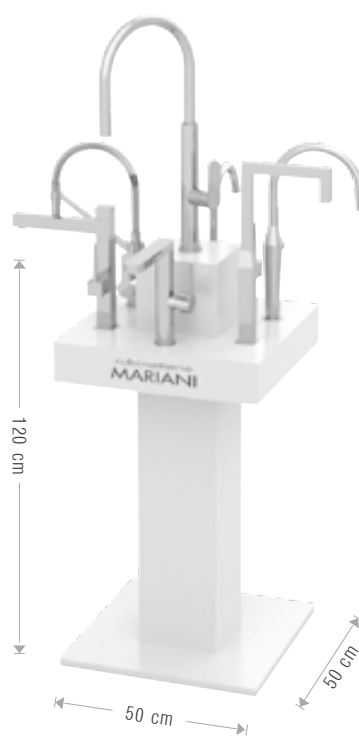
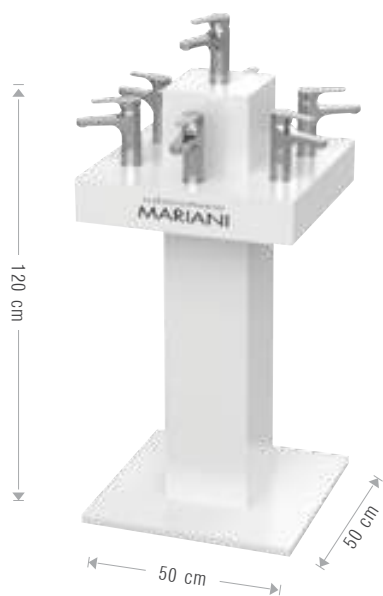

ESPBAS

CONDIZIONI DI VENDITA

INTRODUZIONE

I seguenti termini di vendita e di consegna sono validi per tutte le spedizioni provenienti da questa Società tranne nel caso in cui siano già stati presi accordi diversi per iscritto.

ORDINI

Tutti gli ordini sono soggetti all'approvazione della nostra Società e quindi non ci impegnano alla consegna del materiale ordinato. La conferma dell'ordine comporta per il cliente l'accettazione delle condizioni di vendita indicate dalla nostra Società.

OPUSCOLI; CATALOGHI; ECC.

Le informazioni tecniche e le illustrazioni all'interno dei cataloghi, dei volantini, ecc. possono essere soggette a cambiamenti e correzioni, senza preavviso.

SPEDIZIONE

Salvo accordi diversi presi per iscritto, gli articoli sono spediti franco vettore stabilimento e, conformemente agli usi commerciali in essere, provvederemo direttamente a stipulare il relativo contratto di trasporto per Vostro conto con addebito fattura.

A meno che non siano stati presi accordi scritti diversi, la data di trasferimento rischi viene fissata in base a regole internazionali di interpretazione di espressioni commerciali (Incoterms) emanate dalla Camera di Commercio Internazionale, valide all'atto di accettazione dell'ordine.

DATA DI SPEDIZIONE

Ci impegnamo ad effettuare le consegne dei beni da voi acquistati in conformità alle indicazioni poste negli ordini da Voi inviatici: in ogni caso, salvo diversi accordi, la data d'effettiva consegna Vi verrà comunicata a mezzo conferma d'ordine. Mariani non sarà comunque responsabile nei confronti dell'acquirente per qualsivoglia perdita lo stesso dovesse subire a causa della mancata tempestiva consegna, quando quest'ultima sia dovuta a ritardi nella produzione.

PREZZI

Gli articoli vengono generalmente offerti ai prezzi indicati nei preventivi o nelle conferme d'ordine. Nel caso in cui si dovesse verificare un aumento dei prezzi delle materie prime, del costo del lavoro o della manodopera, prima della data di spedizione fissata, i prezzi verranno modificati.

Tutti i prezzi si intendono IVA esclusa.

RESI

Gli articoli possono essere restituiti solo con la nostra autorizzazione preventiva e franco destino, deducendo il 35% del prezzo fatturato. Nel caso di articoli non standard o articoli che al momento della restituzione mostrano un deterioramento rispetto alla loro condizione al momento della nostra consegna, ci riserviamo il diritto di richiedere ulteriori detrazioni.

GARANZIA PER VIZI

La merce che presenta difetti di produzione può essere resa alla nostra Società senza le detrazioni indicate nel punto precedente. Tuttavia tali articoli sono cambiati o sostituiti senza detrazioni se vengono rimandati alle nostre fabbriche entro un periodo massimo di due anni dalla data di spedizione. In ogni caso, la garanzia scade un anno dopo la data in cui l'articolo è stato utilizzato per la prima volta. La garanzia è valida solamente a condizione che il difetto sia dovuto all'errata lavorazione o al materiale difettoso e non sia invece causato da un utilizzo errato, dalla cattiva manutenzione, dalla trascuratezza o da qualsiasi altra causa anomala che ne provochi il logorio o il deterioramento.

La garanzia è limitata solo ed esclusivamente alla sostituzione della parte difettosa e non ci assumiamo nessuna responsabilità per perdite o danni a persone, beni o proprietà diverse, a danni per perdita di produzione, del profitto, o qualunque altra perdita a meno che non siano stati presi accordi diversi.

FORZA MAGGIORE

La Società non si assume le responsabilità di ritardi, annullamenti o altri problemi che dipendono da conflitti di lavoro o altre simili circostanze indipendenti dalla volontà delle parti come incendi, guerre, chiamate alle armi impreviste, requisizioni, sequestri, disposizioni valutarie restrittive, rivolte e disordini, mancanza di mezzi di trasporto. A tal fine la Società comunicherà per iscritto all'acquirente le cause dell'eventuale ritardo o dell'evento che ha dato luogo all'annullamento dell'ordine.

La consegna e/o l'adempimento rimarrà sospeso durante il periodo in cui avrà efficacia la causa di forza maggiore. Comunque, trascorsi i sei mesi di sospensione, ciascuna Parte avrà diritto di risolvere la vendita.

LEGGE APPLICABILE E FORO

I diritti e gli obblighi delle Parti derivanti dalla vendita saranno regolati dalla Legge Italiana. Per qualsiasi contestazione resta convenuto che il foro esclusivamente competente è quello di Bergamo.

Stampato nel mese di Ottobre 2021

RubINETTERIE Mariani S.r.l. si riserva il diritto di effettuare modifiche tecniche ed estetiche sui prodotti, senza preavviso alla clientela.

TERMS OF SALES AND DELIVERY

INTRODUCTION

The following terms of sale and delivery must be applied to all shipments from this company except where an alternative written agreement has been established.

ORDERS

All the orders are subject to the confirmation by our Firm therefore we are not committed to deliver the goods ordered.

By sending the order confirmation the customer will automatically accept the sale terms here stated by our Firm.

LITERATURE, CATALOGUES, ETC.

Technical information and illustrations in catalogues, leaflets, etc. may be subjected to modifications and amendments without prior notice.

SHIPMENT.

Unless otherwise written agreement, articles are sold ex-works, and according to the existing commercial terms, we will provide to issue the relative transport agreement on your account charging you the cost. Unless otherwise written agreements the date of transfer of risk shall be determining on the basis of international rules for the interpretation of commercial expression issued by the international chamber of commerce and valid at the time of acceptance of the order.

DATE OF DESPATCH.

We commit ourselves to deliver the goods purchased by you in accordance with the requests given in the orders you send us: in any case, except different agreements, the effective date of delivery will be communicated by order confirmation. Mariani will be not responsible towards the buyer for any consequential losses due to the late despatch.

PRICES.

Articles are normally supplied at the prices stated in quotations or order confirmations. In the event of an increase in prices of raw-materials or labour before the date of despatch, the prices will be automatically adjusted.

All prices are VAT excluded.

RETURNED GOODS.

Articles can only be returned with our prior permission and carriage paid by deducting 35% of the invoiced price. In the case of non-standard articles or articles that show a deterioration in their condition, we reserve the right to make deductions.

GUARANTEE.

Articles with a manufacturing defects can be returned to our Society without the deductions indicated in the previous point. However, the guarantee expires one year after the date on which the article was used for the first time.

The guarantee is only valid if the defect is due to faulty workmanship or defective material and is not caused by incorrect use, poor maintenance, negligence or any other abnormal conditions causing wear and tear. The guarantee is strictly limited to the replacement of the defective part only and no liability or responsibility is accepted for loss or damage to any person, goods or property, loss of production time, profit or any other loss unless otherwise written agreement.

FREEDOM FROM RESPONSABILITY.

The Company cannot take responsibility for delays, cancellations or other problems resulting from working conflicts and other similar circumstances beyond the control of parties such as fires, wars, mobilizations or unforeseen military calling or corresponding extent, requisition, confiscation, currency restrictions, revolts and disturbances, lack of means of transport. The Company will inform the buyer about the reasons of eventual delay or event which had caused the cancellation of the order. The delivery and/or fulfilment will remain suspended during the period in which the cause of absolute necessity will take place.

However, after the six months of interruption, each party will have the right to terminate the sale.

ARBITRATION.

The rights and the duties of the parts following to the sale will be settled by the Italian law. For any dispute it is agreed that the exclusively competent Court is the one of Bergamo.



rubinetterie
MARIANI

Via Berlino, 2/4 - 24040 Verdellino - Zingonia (Bg)
Tel. +39 035 41 92 911 - Fax +39 035 41 92 925
info@rubmar.it - www.rubinetteriemariani.it
P. Iva IT 03442080168 - C.F.03442080168

