

rubinetterie
MARIANI



AVENUE





AVENUE





AVENUE è una collezione di rubinetteria monocomando dal forte impatto moderno ed essenziale.

Sviluppato intorno ad una cartuccia dal diametro di 25 mm, il design del miscelatore esprime un'innata eleganza e crea un perfetto accordo tra forme tondeggianti, superfici piane e linee squadrate. Il profilo estremamente sottile e lineare viene poi ulteriormente assottigliato dall'accentuarsi delle sfaccettature sulla bocca e dall'aeratore a scomparsa.

La collezione è dotata di cartuccia a dischi ceramici Ø 25 mm per lavabo e bidet e Ø 35 mm per incassi doccia.

AVENUE is a single-lever mixers collection with a strong modern and essential impact.

Developed around a 25 mm diameter cartridge, the design of the mixer expresses an innate elegance and creates a perfect harmony between rounded shapes, flat surfaces and squared lines. The extremely thin and linear profile is then further thinned by the faceting accentuation on the spout and by the concealed aerator.

The collection is equipped with ceramic disc cartridge, Ø 25 mm for basin and bidet and Ø 35 mm for shower mixer.

OPZIONI DI FINITURA

La collezione AVENUE è disponibile con 3 diverse opzioni di finitura, oltre al cromato: Nero Opaco (.14), Bianco Opaco (.37), Nichel Spazzolato (.08). Indicare il codice di finitura al momento dell'ordine.



AVENUE

FINISHING OPTIONS

AVENUE collection is available with 3 different finishing options, in addition to chrome: Matt Black (.14), Matt White (.37), Brushed Nickel (.08). Refer to the finishing code when ordering.



Nero Opaco
Matt Black

.14



Bianco Opaco
Matt White

.37



Nichel Spazzolato
Brushed Nickel

.08



393/AV



393AV

Miscelatore monocomando lavabo con scarico.
Single-lever basin mixer with pop-up waste.

CR

FIN (.14 .37 .08)



398AV

Miscelatore monocomando lavabo alto senza scarico.
High basin mixer without waste.

CR

FIN (.14 .37 .08)



380AV

Miscelatore monocomando lavabo senza scarico e senza foro sul corpo.
Single-lever basin mixer without waste and without body hole.

CR

FIN (.14 .37 .08)



305AV

Miscelatore monocomando lavabo due fori senza scarico.
Two holes single-lever basin mixer without waste.

CR

FIN (.14 .37 .08)

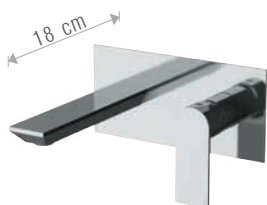
**565AV**

Miscelatore monocomando lavabo ad incasso, completo.
Built-in single-lever basin mixer, complete

CR

FIN (.14 .37 .08)

**565AVP**

Miscelatore monocomando a incasso per lavabo su doppia piastra, completo
Single-lever built-in basin mixer with double flanges, complete

CR

FIN (.14 .37 .08)

565AVE

Solo parte esterna
Only external component

CR

FIN (.14 .37 .08)

565AVINC

Solo parte incasso
Only built-in components

CR

FIN (.14 .37 .08)

565AVPE

Solo parte esterna
Only external component

CR

FIN (.14 .37 .08)

565AVINC

Solo parte incasso
Only built-in components

CR

FIN (.14 .37 .08)

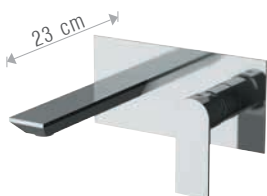
**565AVL**

Miscelatore monocomando lavabo ad incasso, completo
Built-in single-lever basin mixer, complete

CR

FIN (.14 .37 .08)

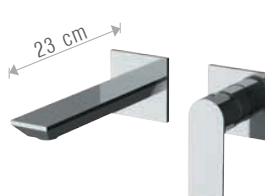
**565AVPL**

Miscelatore monocomando a incasso per lavabo su doppia piastra, completo
Single-lever built-in basin mixer with double flanges, complete.

CR

FIN (.14 .37 .08)

565AVLE

Solo parte esterna
Only external component

CR

FIN (.14 .37 .08)

565AVINC

Solo parte incasso
Only built-in components

CR

FIN (.14 .37 .08)

565AVPLE

Solo parte esterna
Only external component

CR

FIN (.14 .37 .08)

565AVINC

Solo parte incasso
Only built-in components

CR

FIN (.14 .37 .08)

**493AV**

Miscelatore monocomando bidet con scarico.
Single-lever bidet mixer with pop-up waste.

CR

FIN (.14 .37 .08)

480AV

Miscelatore monocomando bidet senza scarico con foro sul corpo.
Single-lever bidet mixer without waste with body hole.

CR

FIN (.14 .37 .08)

**185AVW**

Miscelatore incasso per shut-off comprensivo di doccetta shut-off, supporto doccia, presa acqua, su piastra in ottone cromato e flessibile doccia da 120 cm.
Built-in shut-off mixer set including shut-off handshower, connection pipe on flange, completely in c.p. brass and shower flexible 120 cm.

CR

FIN (.14 .37 .08)





565/AVL

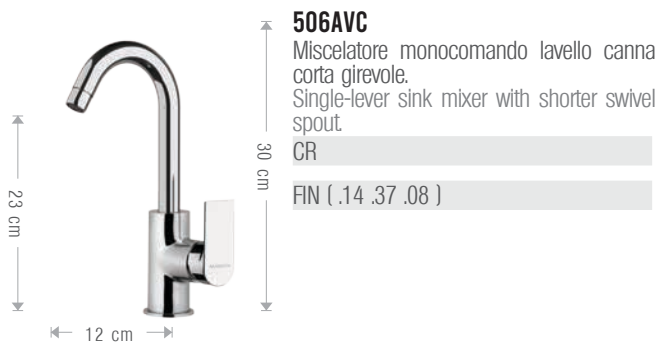

230/AVL

**179AV**

Miscelatore monocomando incasso, completo.
Concealed single-lever shower mixer, complete

CR

FIN (.14 .37 .08)

**173AV**

Miscelatore monocomando incasso con deviatore, completo.
Concealed single-lever shower mixer with diverter, complete.

CR

FIN (.14 .37 .08)

179AVE

Solo parte esterna
Only external component

CR

FIN (.14 .37 .08)

179INC35

Solo parte incasso
Only built-in components

CR

FIN (.14 .37 .08)

173AVE

Solo parte esterna
Only external component

CR

FIN (.14 .37 .08)

173INC35

Solo parte incasso
Only built-in components

CR

FIN (.14 .37 .08)

**173AVP2**

Miscelatore monocomando per doccia con deviatore a 2 vie su unica piastra, completo.
Single-lever built-in shower mixer with 2 ways diverter on single flange, complete.

CR

FIN (.14 .37 .08)

**173AVP3**

Miscelatore monocomando per doccia con deviatore a 3 vie su unica piastra, completo.
Single-lever built-in shower mixer with 3 ways diverter on single flange, complete.

CR

FIN (.14 .37 .08)

173AVP2E

Solo parte esterna
Only external component

CR

FIN (.14 .37 .08)

173INC2P

Solo parte incasso
Only built-in components

CR

FIN (.14 .37 .08)

173AVP2E

Solo parte esterna
Only external component

CR

FIN (.14 .37 .08)

173INC3P

Solo parte incasso
Only built-in components

CR

FIN (.14 .37 .08)

**173AVP4**

Miscelatore monocomando per doccia con deviatore a 4 vie su unica piastra.
Single-lever built-in shower mixer with 4 ways diverter on single flange.

CR

FIN (.14 .37 .08)

**173AVPP4**

Miscelatore monocomando per doccia con deviatore a 4 vie su doppia piastra.
Single-lever built-in shower mixer with 4 ways diverter on double flange.

CR

FIN (.14 .37 .08)

173AVP5

Miscelatore monocomando per doccia con deviatore a 5 vie su unica piastra.
Single-lever built-in shower mixer with 5 ways diverter on single flange.

CR

FIN (.14 .37 .08)

173AVPP5

Miscelatore monocomando per doccia con deviatore a 5 vie su doppia piastra.
Single-lever built-in shower mixer with 5 ways diverter on double flange.

CR

FIN (.14 .37 .08)



252AV

Miscelatore monocomando doccia senza accessori.
Wall mtg. single-lever shower mixer without accessories.

CR

FIN (.14 .37 .08)



254AV

Miscelatore monocomando doccia esterno con leva frontale, senza kit doccia.
Wall mounted single-lever shower mixer with front lever, without shower kit

CR

FIN (.14 .37 .08)



260AVAQX25

Colonna doccia a 3 vie composta da: miscelatore vasca/doccia con deviatore integrato nella bocca; soffione ultrapiatto 25x25 cm in acciaio INOX lucidato (SQ00425); colonna telescopica in ottone con altezza regolabile; doccetta rettangolare piatta a 1 funzione, in ottone (191D9); flessibile 150 cm.
3-way shower column including: bath/shower mixer with diverter integrated in the spout; 25x25 cm ultra-flat shower head in polished stainless steel (SQ00425); height-adjustable telescopic brass column; 1-function flat rectangular hand shower, in brass (191D9); 150 cm flexible hose.

CR



259AVAQX25

Colonna doccia composta da: miscelatore esterno con attacco superiore (259AV); soffione ultrapiatto 25x25 cm in acciaio INOX lucidato (SQ00425); colonna telescopica in ottone con altezza regolabile, deviatore; doccetta rettangolare piatta a 1 funzione, in ottone (191D9); flessibile 150 cm.
Shower column including: exposed mixer with upper connection (259AV); 25x25 cm ultra-flat shower head in polished stainless steel (SQ00425); height-adjustable telescopic brass column with diverter; 1-function flat rectangular hand shower, in brass (191D9); 150 cm flexible hose.

CR



260AVXQX25

Colonna doccia a 3 vie composta da: miscelatore vasca/doccia con deviatore integrato nella bocca; soffione ultrapiatto 25x25 cm in acciaio INOX lucidato (SQ00425); colonna con fissaggio superiore scorrevole; doccetta rettangolare piatta a 1 funzione, in ottone (191D9); flessibile 150 cm.
3-way shower column including: bath/shower mixer with diverter integrated in the spout; 25x25 cm ultra-flat shower head in polished stainless steel (SQ00425); column with sliding upper fixing; 1-function flat rectangular hand shower, in brass (191D9); 150 cm flexible hose.

CR



259AVXQX25

Colonna doccia composta da: miscelatore esterno con attacco superiore (259AV); soffione ultrapiatto 25x25 cm in acciaio INOX lucidato (SQ00425); colonna con fissaggio superiore scorrevole, deviatore; doccetta rettangolare piatta a 1 funzione, in ottone (191D9); flessibile 150 cm.
Shower column including: exposed mixer with upper connection (259AV); 25x25 cm ultra-flat shower head in polished stainless steel (SQ00425); column with sliding upper fixing and diverter; 1-function flat rectangular hand shower, in brass (191D9); 150 cm flexible hose.

CR



260/AV A QX25



Set doccia composto da: miscelatore a incasso con deviatore a 2 vie su unica piastra (173AVP2); soffione ultrapiatto 20x20 cm in acciaio INOX lucidato (SQ00420); braccio a parete in ottone 30 cm (BD00330); doccetta rettangolare piastra a 1 funzione, in ottone (191D9); presa acqua con supporto fisso (242PA); flessibile 150 cm.
Shower set including: built-in mixer with 2-way diverter on a single plate (173AVP2); 20x20 cm ultra-flat shower head in polished stainless steel (SQ00420); 30 cm brass wall arm (BD00330); 1-function flat rectangular hand shower, in brass (191D9); brass connection pipe with shower holder (242PA); 150 cm flexible hose.

17BVP2QX20

con soffione doccia 20x20 cm.
with shower head 20x20 cm.

17BVP2QX25

con soffione doccia 25x25 cm.
with shower head 25x25 cm.

17BVP2QX30

con soffione doccia 30x30 cm.
with shower head 30x30 cm.



Set doccia composto da: miscelatore a incasso con deviatore a 2 vie su unica piastra (173AVP2); soffione ultrapiatto 20x20 cm in acciaio INOX lucidato (SQ00420); braccio a parete in ottone 30 cm (BD00330); saliscendi piatto in ottone; doccetta rettangolare piastra a 1 funzione, in ottone (191D9); presa acqua a muro (752PA); flessibile 150 cm.
Shower set including: built-in mixer with 2-way diverter on a single plate (173AVP2); 20x20 cm ultra-flat shower head in polished stainless steel (SQ00420); 30 cm brass wall arm (BD00330); ultra-flat brass sliding rail; 1-function flat rectangular hand shower, in brass (191D9); wall connection pipe (752PA); 150 cm flexible hose.

17AAVP2QX20

con soffione doccia 20x20 cm.
with shower head 20x20 cm.

17AAVP2QX25

con soffione doccia 25x25 cm.
with shower head 25x25 cm.

17AAVP2QX30

con soffione doccia 30x30 cm.
with shower head 30x30 cm.



17BVP3SR003

Set doccia composto da: miscelatore a incasso con deviatore a 3 posizioni su piastra unica (173AVP3); soffione a parete 50x20 cm con 2 uscite: pioggia e cascata, in acciaio INOX lucidato (SR003); doccetta rettangolare piastra a 1 funzione, in ottone (191D9); presa acqua con supporto fisso (242PA); flessibile 150 cm.
Shower set including: built-in mixer with 3-way diverter on a single plate (173AVP3); 50x20 cm wall shower head with 2 outlets: rain and waterfall, in polished stainless steel (SR003); 1-function flat rectangular hand shower, in brass (191D9); brass connection pipe with shower holder (242PA); 150 cm flexible hose.

CR



17AAVP3SR003

Set doccia composto da: miscelatore a incasso con deviatore a 3 posizioni su piastra unica (173AVP3); soffione a parete 50x20 cm con 2 uscite: pioggia e cascata, in acciaio INOX lucidato (SR003); saliscendi piatto in ottone; doccetta rettangolare piastra a 1 funzione, in ottone (191D9); presa acqua a muro (752PA); flessibile 150 cm.
Shower set including: built-in mixer with 3-way diverter on a single plate (173AVP3); 50x20 cm wall shower head with 2 outlets: rain and waterfall, in polished stainless steel (SR003); ultra-flat brass sliding rail; 1-function flat rectangular hand shower, in brass (191D9); wall connection pipe (752PA); 150 cm flexible hose.

CR

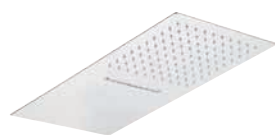

17BVP3SR005

Come 17BVP3SR003:
As 17BVP3SR003:

con soffione a parete 50x22 cm ultrapiatto con 2 uscite: pioggia e cascata, in acciaio INOX lucidato (SR005).
with 50x22 cm ultra-flat wall shower head with 2 outlets: rain and waterfall, in polished stainless steel (SR005).

CR

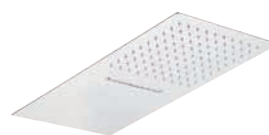

17AAVP3SR005

Come 17AAVP3SR003:
As 17AAVP3SR003:

con soffione a parete 50x22 cm ultrapiatto con 2 uscite: pioggia e cascata, in acciaio INOX lucidato (SR005).
with 50x22 cm ultra-flat wall shower head with 2 outlets: rain and waterfall, in polished stainless steel (SR005).

CR

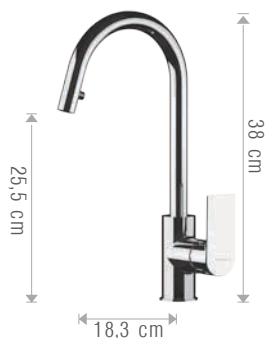
**584AV**

Miscelatore monocomando per lavello, con canna alta girevole e sistema di doccetta monofunzione estraibile.
Single-lever sink mixer with high swivel spout and 1-function pull-out hand shower.

CR

FIN (.14 .37 .08)

**585AV**

Miscelatore monocomando per lavello con canna alta girevole e doccetta estraibile a due funzioni.
Single-lever sink mixer with high movable spout and 2-functions pull-out hand shower.

CR

**506AV**

Miscelatore monocomando lavello, bocca girevole alta.
Single-lever sink mixer with swivel high spout.

CR

FIN (.14 .37 .08)

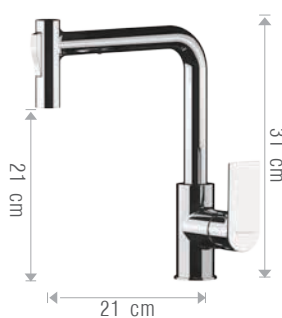
**581AV**

Miscelatore monocomando per lavello, con canna alta girevole e doccetta estraibile con impugnatura a martello a due funzioni.
Single-lever sink mixer with high swivel spout and 2-functions pull-out "hammer shaped" handle hand shower.

CR

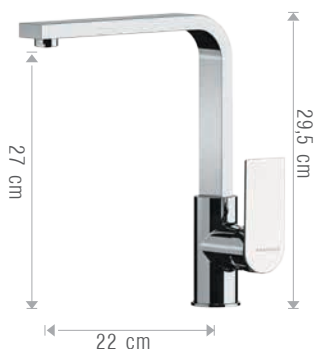
**506AVQ**

Miscelatore monocomando per lavello, con bocca alta girevole a "U".
Single lever kitchen mixer with high swivel "U" spout.

CR

**57DAV**

Miscelatore monocomando lavello a molla con doccetta estraibile a 2 funzioni.
Single-lever sink mixer with spring spout and 2-functions pull-out handshower.

CR

**518AV1**

Miscelatore monocomando lavello con flessibile rivestito in tubo gomma soft-touch nero opaco.
Single-lever sink mixer with flexible hose coated in soft-touch matt black rubber pipe.

CR

**505AVB**

Miscelatore monocomando a parete per lavello, bocca girevole alta.
Wall mounting single-lever sink mixer with swivel high spout.

CR

FIN (.14 .37 .08)



rubinetterie
MARIANI

AVENUE

RUBINETTERIE MARIANI srl:

Via Berlino, 2/4 - 24040 Verdellino - Zingonia (Bg)
Tel. +39 035 41 92 911 - Fax +39 035 41 92 925
info@rubmar.it - www.rubinetteriemariani.it
P. Iva IT 03442080168 - C.F.03442080168